

APPENDIX Q
Traffic Impact Analysis and
Mitigation Plan

CYPRESS POINT TRAFFIC IMPACT ANALYSIS AND MITIGATION PLAN

MOSS BEACH, CALIFORNIA

May 2023



Inside front cover

Page Intentionally blank

Cypress Point Traffic Impact Analysis and Mitigation Plan

Moss Beach, California

Prepared for:
MidPen Housing Corp.
Foster City, CA 94404
650.235.7675

Prepared by:
Kittelson & Associates, Inc.
155 Grand Avenue, Suite 505
Oakland, California 94612
510.839.1742

Project Manager:
Mike Alston, TE
Senior Engineer

Project Principal:
Aaron Elias, PE
Associate Engineer

Project Number 20616

May 2023



Page Intentionally blank

CONTENTS

Executive Summary	1
Project Description	1
Project Impacts	1
Recommended Mitigations.....	1
Local Circulation Effects.....	2
Introduction.....	5
Project Description	5
Data and Analysis Approach.....	10
CEQA Transportation Analysis.....	10
VMT Analysis	10
Impact Criteria.....	11
Local Transportation Analysis	11
Intersection Operations.....	12
Analysis Scenarios	13
Analysis.....	16
Study Area & Intersections	16
Existing Conditions.....	18
Roadway Network.....	18
Transit Service.....	18
Existing Conditions Traffic Volumes	21
Project Vehicle Trip Generation.....	25
Trip Generation	25
Trip Distribution and Assignment	26
VMT Analysis.....	29
Site Access, Circulation & Parking	32
Parking Assessment	32
Electric Vehicle parking	33
Emergency Access	33
Pedestrian & Bicycle Access.....	33
Speed Limits and Sight Distance.....	35
Conclusions and Mitigation Measures.....	37
Vehicle Miles Traveled	37
Sight Distance and Safety Impacts	37
Local Circulation and Traffic Operations	42
Existing Conditions.....	42
Existing No project Conditions.....	42

Existing with Project Conditions	43
Future Conditions	46
Future No project Conditions	46
Future with Project Conditions.....	46
Cumulative Conditions	50
Cumulative No project Conditions	50
Cumulative with Project Conditions	52
Threshold Comparison	56
Recommended Operations Improvements	56
Appendix	60
Appendix 1	61
Turning Movement Counts	61
Appendix 2.....	62
Seasonal Turning Movement	62
Count Adjustments	62
Appendix 3.....	63
Existing Operations Results	63
Appendix 4.....	64
Existing with project Operations Results.....	64
Appendix 5.....	65
Future Operations Results.....	65
Appendix 6.....	66
Future with project Operations Results	66
Appendix 7.....	67
Cumulative Operations Results	67
Appendix 8.....	68
Cumulative with project Operations Results	68
Appendix 9.....	69
TDM Plan	69
Appendix 10.....	70
Signal Warrants	70

LIST OF FIGURES

Figure 1. Project Location	7
Figure 2. Site Plan	8
Figure 3. Study Intersections.....	17
Figure 4. Transit Service in Project Area	20
Figure 5. Existing Traffic Control and Lane Configurations.....	23
Figure 6. Existing Peak Hour Turning Movement Volumes and Operations	24
Figure 7. Project Trips	28
Figure 8: Midcoast Land Use Plan Zoning.....	30
Figure 9: Existing with Project Turning Movement Volumes and Operations	45
Figure 10. Future with Project Turning Movement Volumes and Operations.....	49
Figure 11. Cumulative Conditions Lane Configurations and Traffic Control Devices.....	51
Figure 12. Cumulative with Project Turning Movement Volumes and Operations	55

LIST OF TABLES

Table 1: Level of Service Definition for Intersections.....	12
Table 3: project Trip Generation.....	25
Table 3: Trip Generation Comparison.....	26
Table 4: project Trip Distribution along State Route 1	27
Table 16: Parking Requirements for the project.....	32
Table 17: Average Estimated Parking Demand for the project.....	33
Table 2: Existing Conditions Intersection Operations Results	42
Table 5: Existing with Project Weekday AM Peak Hour Intersection Operations.....	43
Table 6: Existing with Project Weekday PM Peak Hour Intersection Operations	44
Table 7: Existing with Project Saturday Midday Peak Hour Intersection Operations.....	44
Table 8: Future Conditions Intersection Operations Results	46
Table 9: Future with Project Weekday AM Peak Hour Intersection Operations	46
Table 10: Future with Project Weekday PM Peak Hour Intersection Operations.....	47
Table 11: Future with Project Saturday Midday Peak Hour Intersection Operations	48
Table 12: Cumulative Conditions Intersection Operations Results.....	50
Table 13: Cumulative with Project Weekday AM Peak Hour Intersection Operations	53
Table 14: Cumulative with Project Weekday PM Peak Hour Intersection Operations.....	53
Table 15: Cumulative with Project Saturday Midday Peak Hour Intersection Operations	54

APPENDICES

Appendix 1. Turning Movement Counts
Appendix 2. Seasonal Turning Movement Counts Adjustments
Appendix 3. Existing Operations Results
Appendix 4. Existing with project Operations Results
Appendix 5. Future Operations Results
Appendix 6. Future with project Operations Results
Appendix 7. Cumulative Operations Results
Appendix 8. Cumulative with project Operations Results
Appendix 9. TDM Plan
Appendix 10. Signal Warrants

Page intentionally blank.

EXECUTIVE SUMMARY

This report presents the results of the transportation study prepared for the proposed Cypress Point project ("project") in support of its Coastal Development Permit application. This study analyzes the potential transportation impacts and effects of the proposed project. The project is analyzed with respect to potential environmental impacts under the California Environmental Quality Act (CEQA) and for transportation effects on local circulation including consistency with Local Coastal Program (LCP) Policy 2.44.

PROJECT DESCRIPTION

The project is located on the northeast corner of Carlos Street and Sierra Street in the unincorporated community of Moss Beach, San Mateo County, California. The 10.875-acre parcel is currently vacant. The proposed project includes 71 affordable housing units. Access to the project site would be provided by a driveway on Carlos Street near the intersection with Sierra Street.

PROJECT IMPACTS

This report identifies the following CEQA impacts related to potential hazards:

- The existing available corner sight distance at the intersection of State Route 1 and Carlos Street is inadequate, and the addition of project traffic will substantially increase the hazard at this intersection.
- The project will increase pedestrian activity with no existing sidewalks along the project frontage and connecting to destinations, including a bus stop, in Moss Beach.
- The nearest SamTrans bus stop (along State Route 1 at 16th Street) would require pedestrians, including residents of the proposed project, to cross State Route 1 at a location without a marked pedestrian crossing and inadequate sight distance.
- The project may result in a significant impact with respect to vehicle miles traveled, pending further analysis. As part of subsequent environmental review, the County may determine whether to rely on a potential screening option to evaluate the project's vehicle miles traveled (which would assume a less-than-significant impact) or a more quantitative analysis approach.

RECOMMENDED MITIGATIONS

Provide additional Transportation Demand Management (TDM) Features

The project's proposed TDM plan includes a package of measures that would be expected to reduce project vehicle trips. The TDM plan would require the project to distribute educational information to residents related to transportation options, bus routes, and transportation safety to address pedestrian safety impacts.

In addition to the TDM elements required as part of the C/CAG TDM Checklist (included as Appendix 9), it is recommended that the project also construct as mitigation measures sidewalk, crosswalk, bicycle route, and transit infrastructure improvements that would improve conditions within Moss Beach for pedestrians and bicyclists.

Address State Route 1 / Carlos Street Sight Distance

The limited sight distance at State Route 1/Carlos Street is deficient for operating conditions. The intersection would provide the main access to and from State Route 1 for the project. This report identifies

an impact related to adding project vehicle trips at this intersection and identifies a combination of mitigation measures that would reduce the impact to less than significant. The mitigation measures include a transportation demand management (TDM) plan and closure of Carlos Street between the Project and State Route 1 to all but emergency vehicles. At the time of this writing, the County is working on a Caltrans Project Initiation Document (PID) as part of the Moss Beach State Route 1 Congestion & Safety Improvements Project. With this project, the County will determine feasibility for a traffic signal and roundabout at a combined State Route 1 / 16th Street / Carlos Street intersection, which would also address the impact and could eventually replace the identified mitigation measure. Implementation authority for that project would rest jointly with the County and Caltrans and is therefore out of the County's exclusive control.

LOCAL CIRCULATION EFFECTS

The results of the operational analysis show project effects degrading the operations to below the level of service standard or adding at least four seconds of delay if the intersection is already below the standard at the following intersections:

- **State Route 1 & California Avenue/Wienke Way** in Existing with project weekday PM and Saturday midday peak hour; in Future with project weekday PM and Saturday midday peak hours; and in Cumulative with project weekday AM, weekday PM, and Saturday midday peak hours;
- **State Route 1 & 16th Street** in the Cumulative with project weekday PM peak hour;
- **State Route 1 & Carlos Street** in the Cumulative with project weekday AM and PM peak hours;
- **State Route 1 & Vallemar Street / Etheldore Street** in Cumulative with project weekday PM peak hour conditions.

Recommended Improvements

Change the intersection control at State Route 1 & California Avenue / Wienke Way

The operational analysis shows that a change of intersection control at this intersection would provide Level of Service (LOS) B or better in all conditions and scenarios assuming the intersection is converted from side street stop control to signalization as recommended in San Mateo County's draft *Connect the Coastsides* report. A preliminary analysis of changing the intersection control to a roundabout showed a single-lane roundabout option would meet applicable LOS standards as well. A change of traffic control is recommended as a near-term (0 to 7 years) improvement in the County's *Connect the Coastsides Report*. However, any change of control at this intersection would be subject to an intersection control evaluation (ICE) report as part of Caltrans procedures; the ICE would compare signal-control and roundabout alternatives to make a final determination on the appropriate intersection control. Final determination and approval authority would require Caltrans approval and does not rest within the County's exclusive control.

¹ The County is currently studying a project that would remove this intersection and provide an alternative intersection geometry, configuration and traffic control. For more information, see the Impact T-1 discussion in the Sight Distance and Safety Impacts section beginning on page 37.



Introduction

INTRODUCTION

Kittelson & Associates, Inc. (Kittelson) has prepared this transportation study of the proposed Cypress Point affordable housing project ("project") in Moss Beach, San Mateo County, California. This study provides two levels of analysis and evaluation:

- California Environmental Quality Act (CEQA) Transportation Analysis
- Local transportation analysis for circulation effects and consistency with Local Coastal Program (LCP) Policy 2.44.

Each analysis approach is described in the Data and Analysis Approach section.

PROJECT DESCRIPTION

The project is an affordable housing project located in the coastal zone on a 10.875-acre parcel adjacent to the northeast corner of Carlos Street and Sierra Street in the unincorporated community of Moss Beach, San Mateo County, California (Figure 1). The property is bounded by vacant land to the southwest (towards State Route 1 [SR1]), residential properties along 16th Street to the northwest (in the community of Montara), and residential properties along Carlos, Sierra, and Lincoln Streets on the other two sides. Individual houses along Stetson Street and Buena Vista Street also border the property.

MidPen proposes the development of 71 affordable housing units on this lot, consisting of approximately 22 two-story buildings holding 2-4 units each (Figure 2). The project would provide a mixture of 1, 2, and 3-bedroom units, including a combination of two-story townhouses and ADA-accessible 1-story flats. All the units, except for the manager's apartment, will be affordable to households earning less than 80% of the Area Median Income (AMI). It is expected that the Cypress Point project will provide housing for approximately 213 people, including adults and children.

In addition to the housing units, the development would include an approximately 3,200 square foot community building, that will include the general office, the manager's office, a community room, kitchen, computer room, laundry, and maintenance and storage areas (Figure 2). The project plan also includes several outdoor amenities, including:

- Landscaping;
- A community garden;
- A children's play area;
- An upper and a lower green;
- BBQ areas; and
- A publicly accessible walking trail.

The project site would include a driveway along Carlos Street and 142 vehicle parking spots, with 5 electric vehicle parking spots in a loop surface parking lot.² The site would include racks providing for eight short-term bicycle parking spaces and 36 long-term (i.e., indoors and secure) bicycle parking spaces.

The project also includes a transportation demand management (TDM) plan (see Appendix 9) in accordance with C/CAG requirements (see Appendix 9). The TDM plan includes the following measures:

- M2 – Orientation, Education, Promotional Programs, and/or Materials

² This number may change as required by updated code requirements; the project sponsor will coordinate with the County on any changes to requirements and required project description changes.

- M3 – TDM Coordinator/Contact Person
- M6 – Transit or Ridesharing Passes/Subsidies
- M8 – Secure Bicycle Storage
- M9 – Design Streets to Encourage Bike/Ped Access
- M11 – Family-supportive Amenities
- M22 – Active Transportation Subsidies
- M23 – Gap Closure
- M24 – Bike Repair Station

Based on the TDM Checklist, this combination of TDM measures can be expected to reduce project vehicle trips substantially.



**Project Vicinity
Moss Beach, California**

**Figure
1**

C:\Program Files\Autodesk\AutoCAD 2022\Drawing1.dwg Jun 28, 2022 - 7:27pm - ktaio Layout Tab: Layout1

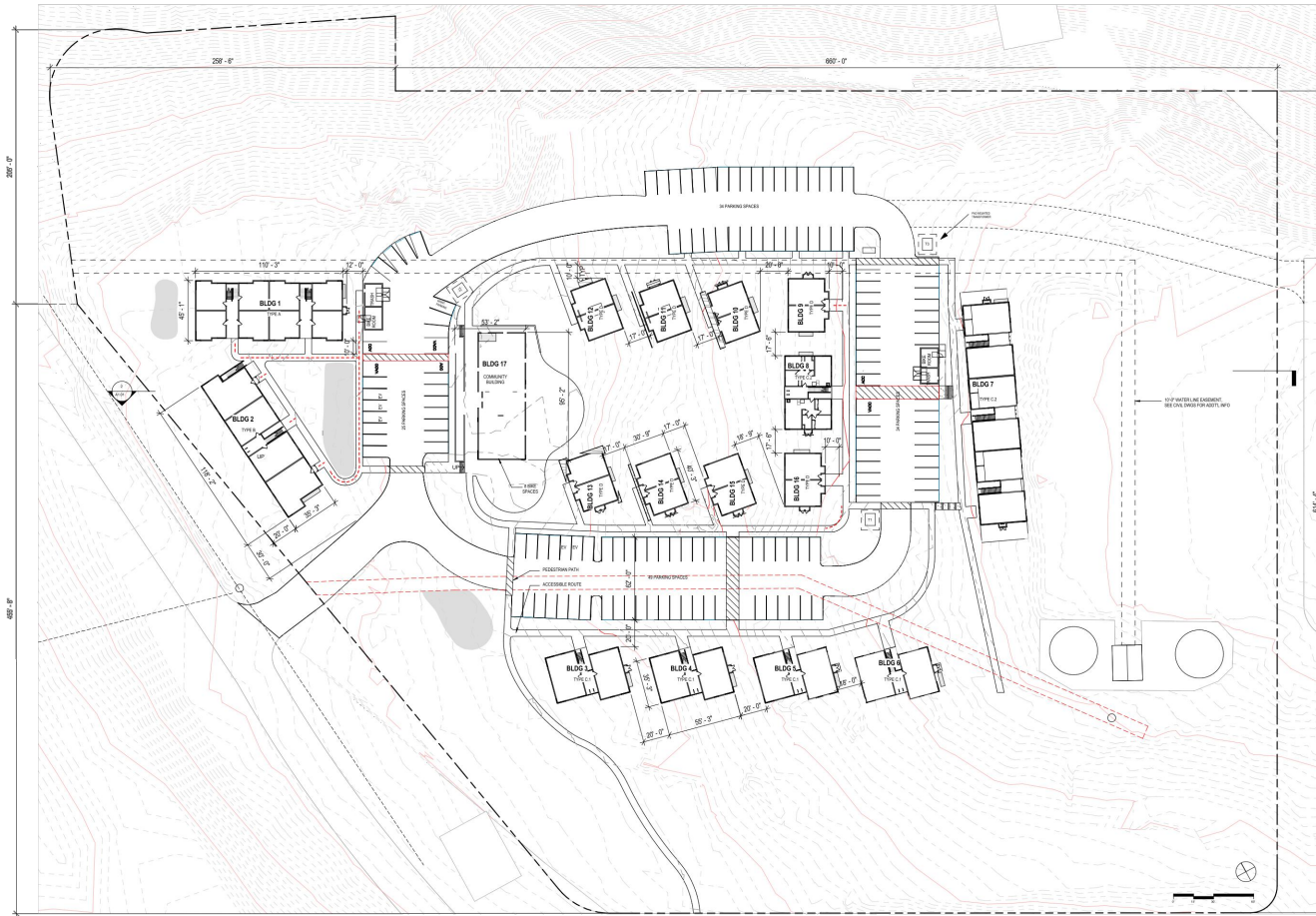

SITE PLAN BACKGROUND 1

PVATOK
 1000 PLYMOUTH STREET, SUITE 100
 SAN MATEO, CA 94401
 (650) 351-1000

PROJECT: CYPRESS POINT FAMILY COMMUNITY
 CLIENT: KITTTELSON & ASSOCIATES

DATE: 06/28/2022

SCALE: 1" = 100'

PROJECT LOCATION: Cypress Point, San Mateo County, CA

CYPRESS POINT FAMILY COMMUNITY
 Carlos Street, Moss Beach

NO. 1000 1001

DATE: 06/28/2022

SCALE: 1" = 100'

PROJECT LOCATION: Cypress Point, San Mateo County, CA

A1.0

Cypress Point
Tentative Site Plan
San Mateo County, CA

Figure
2



Data and Analysis Approach

DATA AND ANALYSIS APPROACH

The project is analyzed based on the San Mateo County *Traffic Analysis and Mitigation Approach for "Small" projects*³ for its effect on local circulation and safety. As explained on the County of San Mateo Public Works website:

Effective July 1, 2020, the County of San Mateo has transitioned to using Vehicle Miles Traveled (VMT) instead of Level of Service (LOS) as the metric for determining transportation-related impacts under CEQA.

In the past, CEQA transportation-related impacts from a proposed project have been evaluated based on LOS, which measures delay at signalized intersections surrounding the proposed project. Projects determined to have significant impacts based on LOS are required to mitigate these impacts by road widenings, signal improvements, or similar measures to maintain operational efficiency and capacity.

Therefore, the analysis in this report is present in two sections: first, a CEQA Transportation Analysis section which evaluates the project for potential environmental impacts and second, a Local Transportation Analysis section which evaluates local circulation effects. The approach for each is described below.

CEQA TRANSPORTATION ANALYSIS

The California Environmental Quality Act (CEQA) Guidelines, Appendix G Environmental Checklist Form describes four recommended categories of impacts related to transportation and traffic. These categories are recommended for formal environmental review of projects but are referenced as appropriate for this TIA. The proposed project's impact would be considered significant if it would:

- d. Conflict with a program, plan, ordinance, or policy addressing the circulation system, including transit, roadway, bicycle, and pedestrian facilities.
- b. Conflict with or be inconsistent with CEQA Guidelines section 15064.3, subdivision (b).
- c. Substantially increase hazards due to a geometric feature (e.g., sharp curves or dangerous intersections) or incompatible uses (e.g., farm equipment).
- d. Result in inadequate emergency access.

Significance criteria "b" is related to the implementation of vehicle miles traveled (VMT) as the primary performance metric as described above.

VMT ANALYSIS

Senate Bill 743 (SB 743) was signed into law in September 2013. Senate Bill 743 (Steinberg, 2013) required changes to the California Environmental Quality Act (CEQA) Guidelines regarding the analysis of transportation impacts. The purpose of SB 743 is to promote the reduction of greenhouse gas emissions, the development of multimodal transportation networks, and a diversity of land uses.

Prior to implementation of SB 743, CEQA transportation analyses of individual projects typically determined impacts on the circulation system in terms of roadway delay and/or capacity usage at specific locations, such as street intersections or freeway segments. The SB 743 changes include the elimination of auto delay, level of service (LOS), and other similar measures of vehicular capacity or traffic congestion as a basis for determining significant impacts.

³ San Mateo County Traffic Analysis and Mitigation Approach for "Small" projects subject to LCP 2.52 (November 2020).

Under SB 743, a project's effect on automobile delay shall not constitute a significant environmental impact. Therefore, level of service (LOS) and other similar vehicle delay or capacity metrics can no longer serve as transportation impact metrics for CEQA analysis. The California Office of Planning and Research (OPR) updated the CEQA Guidelines and provided a final technical advisory in December 2018, which recommends vehicle miles traveled (VMT) as the most appropriate measure of transportation impacts under CEQA. The California Natural Resources Agency certified and adopted the CEQA Guidelines including the Guidelines section implementing SB 743. The changes have been approved by the Office of the Administrative Law and are now in effect.

Each agency applies its own analysis procedures and thresholds of significance. Many jurisdictions have developed screening methodologies to evaluate whether a project would require detailed VMT analysis or if it would be unlikely to result in an a VMT-related impact (and can thus forego detailed analysis). Assessing VMT is not yet reflected in the LCP, County Traffic Impact Study Requirements, or C/CAG's Traffic Impact Analysis Policy.

However, in lieu of final thresholds still under development, the County is using OPR's recommendations with some modifications that are relevant to the project. The County lists the following thresholds and screening criteria, as well as significance criteria:

- **Residential project threshold:** 15% below baseline for home-based work trip per capita by residence. (The baseline County average is 13.60 home-based trip VMT per resident.)
- **Affordable housing screening criteria guidance:** projects that are 100% affordable housing in infill areas typically generate lower VMT than market-rate housing.

Revisions to CEQA transportation analysis requirements do not preclude the application of local general plan policies, municipal and zoning codes, conditions of approval, or any other planning requirements through a city's planning approval process. These requirements aim to ensure adequate operation of the transportation system in terms of transportation congestion measures related to vehicular delay and roadway capacity.

IMPACT CRITERIA

For this report's analysis, the project will be considered to have a significant impact if:

- The project will substantially increase hazards due to a design feature (e.g., sharp curves or dangerous intersections) or incompatible uses (e.g., farm equipment). For this study the project would "substantially increase hazards due to a design feature or incompatible use" if it would increase traffic volumes for movements that have restricted sight distance for existing posted speeds per Caltrans *Highway Design Manual* standards.
- The project would result in more than 11.56 daily home-based VMT per capita by residence. (This represents a 15% reduction from the baseline County average of 13.60 home-based trip VMT per resident.) It could be exempt from detailed VMT analysis if it meets County screening criteria.

LOCAL TRANSPORTATION ANALYSIS

The County typically does not require a traffic report for projects that generate fewer than 100 trips during the peak hour but in the interest of sharing information, this report has been prepared to include local circulation and traffic operations effects. The local transportation analysis is provided for informational purposes.

INTERSECTION OPERATIONS

Level of service (LOS) describes the operating conditions experienced by motorists. LOS is a qualitative measure of the effect of a number of factors, including speed and travel time, traffic interruptions and delay, freedom to maneuver, driving comfort, and convenience. LOS A through LOS F covers the entire range of traffic operations that might occur. Motorists using a facility that operates at LOS A experience very little delay, while those using a facility that operates at LOS F will experience long delays. Intersection analyses for the ten study intersections were conducted using the operational methodologies outlined in the 2010 Highway Capacity Manual (HCM) (Transportation Research Board, Washington, D.C., 2010).

Signalized intersection. The HCM procedure calculates a weighted average control delay in seconds per vehicle at a signalized intersection and assigns a level of service designation based upon the delay.

Unsignalized intersection. The HCM methodology calculates a weighted average control delay in seconds per vehicle for each controlled intersection leg and for the intersection. A level of service designation for all-way stop-controlled intersections is based upon the weighted average control delay for all intersection legs, similar to the level of service designation for signalized intersections. For two-way stop-controlled intersections, the LOS for the worst approach is used as the LOS performance measure.

Table 1 presents the relationship of average delay to level of service for both signalized and unsignalized intersections.

Table 1: Level of Service Definition for Intersections

Signalized Intersection Average Delay Per Vehicle (Seconds)	LOS	Description of Traffic Conditions	Unsignalized Intersection Average Delay Per Vehicle (Seconds)
≤10.0	A	Free flowing. Most vehicles do not have to stop.	≤10.0
>10.0 and ≤20.0	B	Minimal delays. Some vehicles have to stop, although waits are not bothersome.	>10.0 and ≤15.0
>20.0 and ≤35.0	C	Acceptable delays. Significant numbers of vehicles have to stop because of steady, high traffic volumes. Still, many pass without stopping.	>15.0 and ≤25.0
>35.0 and ≤55.0	D	Tolerable delays. Many vehicles have to stop. Drivers are aware of heavier traffic. Cars may have to wait through more than one red light. Queues begin to form, often on more than one approach.	>25.0 and ≤35.0
>55.0 and ≤80.0	E	Significant delays. Cars may have to wait through more than one red light. Long queues form, sometimes on several approaches.	>35.0 and ≤50.0
>80.0	F	Excessive delays. Intersection is jammed. Many cars have to wait through more than one red light, or more than 60 seconds. Traffic may back up into "up-stream" intersections.	>50.0

Source: Transportation Research Board, Highway Capacity Manual, Washington, D.C., 2010.

Definition of Acceptable Operations

The assessment of the project is based on the Local Coastal Program (LCP). Policy 2.44 states⁴:

In assessing the need for road expansion, consider Service Level D acceptable during commuter peak periods and Service Level E acceptable during recreation peak periods.

Since a roadway segment's capacity is generally controlled by the downstream intersection, an intersection analysis is sufficient for assessing a project's impacts. The analysis in this report therefore considers project effects to be notable if:

- The project will cause an intersection to operate at a LOS that violates the overall standard LOS D in during the weekday AM or PM peak hour (LOS E in the weekend midday peak hour); or if
- An intersection is operating below the LOS standard without the project, but the addition of project-related trips increases the average control delay at the intersection by four seconds or more.⁵

The policy states that these thresholds should be considered when assessing the need for road expansion but does not require capacity increases as a result of conditions below standard.

ANALYSIS SCENARIOS

The evaluation presented in this report was conducted for the following time-of-day/day-of-week peak periods:

- Weekday AM peak hour: 7:00 to 9:00 AM (representing a commuter peak period);
- Weekday PM peak hour: 4:00 to 6:00 PM (representing a commuter peak period); and
- Saturday peak hour: 11:00 AM to 1:00 PM (representing a recreational peak period).

Data were collected (as described in the *Existing Conditions* description below) during each time period, and the hour with the highest vehicle volumes from each of these periods was used in the transportation analysis. The collected multimodal turning movement counts are attached in APPENDIX 1.

The three peak periods described were analyzed for the following analysis scenarios:

- **Existing Conditions:** Represents current conditions. Traffic volumes were developed by seasonal adjustment of data collected on Thursday, April 20, 2017, and Saturday April 22, 2017, in good weather during the school year. Because State Route 1 is a seasonal route, the peak hour traffic volumes collected in April were adjusted to be consistent with the typically busier summer months. The method used to increase the counts to be representative of summer traffic is described in the Existing Conditions Traffic Volumes section and provided in Appendix 2.
- **Existing Project Conditions:** Represents conditions upon implementation of the project. Traffic volumes were developed by combining the seasonally-adjusted existing traffic volumes with the project only volumes.
- **Future Conditions:** Represents near-term future traffic conditions representing conditions when the project would be anticipated to be complete. The Future conditions represent Existing

⁴ County of San Mateo Local Coastal Program Policies 2013. Available at <https://www.smcgov.org/planning/local-coastal-program>. Accessed June 1, 2022.

⁵ This threshold is applied per the County's 2013 Traffic Impact Study requirements, cited here as a way to evaluate an intersection that is already below the standard (available online at <https://www.smcgov.org/media/46076/download?inline=>).

conditions turning movement volumes plus other projects that have been approved or are in the entitlement process but not yet constructed at the time of the traffic counts.

Based on discussions with the San Mateo County Planning and Building Department, the following projects were identified for inclusion in the Future traffic volume. These projects were either approved but not constructed or were in the entitlement process at the time this analysis was conducted. The anticipated trip generation for these two projects was added to the existing seasonally adjusted traffic volumes. Additionally, these projects are of a sufficient size that their traffic may have more than a negligible effect on traffic operations.

- An RV park with 50 spaces and seven tent camping spaces, a single-story 832 square foot laundry and restroom facility, landscape, and drainage improvements; located at the corner of State Route 1 and Capistrano Road in Princeton (PLN2017-00320, associated with PRE2015-00019).
 - Big Wave, a project that includes a 70,500 square-foot Wellness Center with housing for developmentally disabled adults and their aides, 161,263 square feet of office/industrial park, and free public parking for beach access and a gated boat storage yard. This project is located on Airport Street north of the Princeton/Pillar Point Harbor area in unincorporated San Mateo County. It has been approved but not constructed.
- **Future with Project Conditions:** Represents near-term traffic conditions with the addition of project traffic. Traffic volumes for the Future project conditions were developed by combining Future conditions volumes with the project only volumes.
 - **Cumulative Conditions:** Represents the anticipated Cumulative conditions for the study intersections for the year 2040. The C/CAG-VTA San Mateo County Travel Demand Model was used to develop the future volume forecast for Cumulative Conditions. The model includes future development throughout the region. The 2040 cumulative forecasts are consistent with regional growth totals projected by the Association of Bay Area Governments (ABAG) Plan Bay Area.⁶ Therefore, the traffic forecasts reflect both growth in Moss Beach and increases in traffic volumes on State Route 1 due to regional growth. Base year (Year 2013) and future year (Year 2040) forecasts were extracted from the model and linearly interpolated to develop growth between the traffic count year (2017) and the current model horizon year (2040).
 - **Cumulative with Project conditions:** Represents the effect of the project on traffic operations under Cumulative conditions. Traffic volumes for the Cumulative with project conditions were developed using the same additive approach used for the Existing with project and Future with project volumes.

⁶ <https://mtc.ca.gov/our-work/plans-projects/plan-bay-area-2040>



Analysis

ANALYSIS

STUDY AREA & INTERSECTIONS

The purpose of the traffic analysis is to determine whether the project would have transportation-related environmental impacts as defined in the *Data and Analysis Approach* section. Based on discussions with County staff, the following ten intersections were identified to describe an appropriate project study area (Figure 3):

1. State Route 1 & 14th Street;
2. State Route 1 & 16th Street;
3. State Route 1 & Carlos Street;
4. Carlos Street & Sierra Street;
5. Sierra Street & Stetson Street;
6. State Route 1 & Etheldore Street / Vallemar Street;
7. State Route 1 & California Avenue;
8. Carlos Street & California Avenue;
9. California Avenue & Etheldore Street; and,
10. California Avenue & Stetson Street.

As described in the *Data and Analysis Approach* section, these intersections were analyzed in the weekday AM, weekday PM, and weekend midday peak periods for the following scenarios:

- Existing Conditions;
- Existing with Project Conditions;
- Future Conditions;
- Future with Project Conditions;
- Cumulative Conditions; and
- Cumulative with Project conditions.

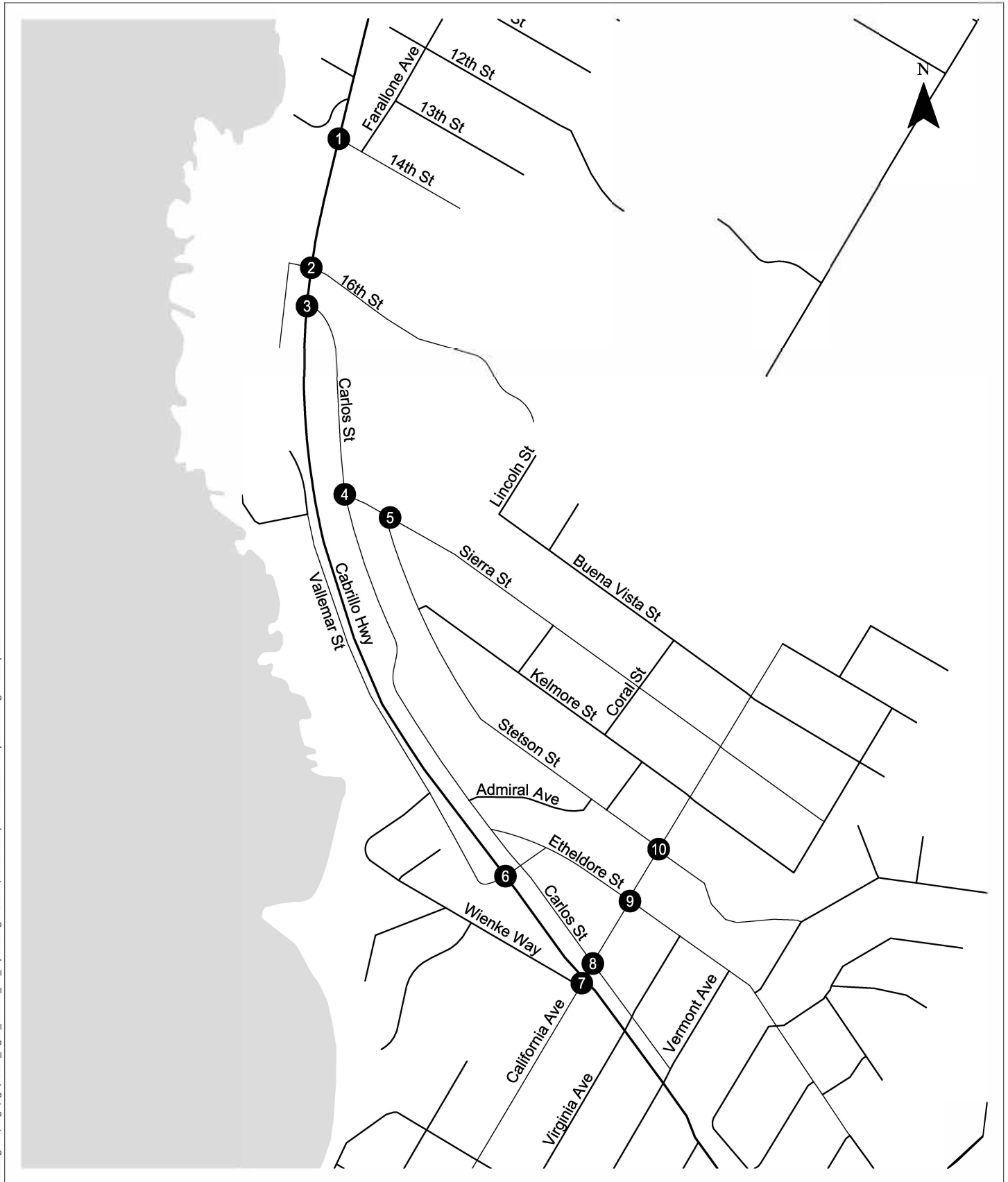

- Study Intersections

Study Area and Study Intersections
Moss Beach, California

Figure
3

H:\20\20616 - Moss Beach Housing TIA\dwgs\Figs\20616 - Fig01_revised_for_report.dwg Jan 10, 2018 - 2:19pm - malston Layout Tab: Fig 3 - Study Area

EXISTING CONDITIONS

ROADWAY NETWORK

Access to the project site is provided off Carlos Street north of Sierra Street. Carlos Street can either be directly accessed from State Route 1 to the north of the project or via State Route 1 south of the project via either Etheldore Street or California Avenue.

- **State Route 1** in the vicinity is a two-lane highway running north-south. State Route 1 provides the only access to Moss Beach, connecting it to destinations in the north such as San Francisco and to destinations to the south such as Half Moon Bay.
- **Carlos Street** is a narrow two-way local street that runs through Moss Beach parallel to State Route 1. Near the project site, Carlos Street has no pavement markings, on-street parking, sidewalks, or bicycle accommodations. Further south in the commercial area of Moss Beach near California Avenue, Carlos Street includes bicycle pavement markings, on-street parking and sidewalks on one side.
- **Etheldore Street** is a two-lane, two-way local street that connects Moss Beach to State Route 1. It extends from the study intersection with State Route 1 and Vallemar Street, through Moss Beach, to State Route 1 further south. Etheldore Street includes intermittent paved sidewalks on its south side and no sidewalks on its north side.
- **California Avenue** is a two-lane, two-way local street that crosses State Route 1 south of the project site, providing State Route 1 access to much of the residential area of Moss Beach. California Avenue in the study area includes paved sidewalks on its west side and no sidewalks on its east side.
- **Stetson Street** is a two-lane, two-way local street that extends from Sierra Street near the project site to Sunshine Valley Road and provides access across Moss Beach. Stetson Street in the study area includes paved sidewalks on its north side and no sidewalks on its south side.
- **Sierra Street** is a two-lane, two-way local street that extends from Carlos Street to Vermont Street and provides residential access across Moss Beach. In the study area, Sierra Street features paved sidewalks on its north side between Coral Street and California Avenue but no paved sidewalks on any other segments.

The 2011 San Mateo County Comprehensive Bicycle and Pedestrian Plan identified planned bikeways through Moss Beach including along Carlos Street but cites no existing bicycle facilities in the study area.

TRANSIT SERVICE

The project site is served by two bus routes (Routes 17 and 18) operated by SamTrans transit service. Service details and changes are the exclusive domain of Samtrans, not San Mateo County. A description of each route, with the closest stops to the project site, is provided below. All route variations are shown in Figure 4.

Route 17

SamTrans Route 17 follows two different northbound routes and two southbound routes.

Northbound

The weekday morning and weekend all-day northbound route include stops at California Avenue / Etheldore Street (0.47 miles from the project) and State Route 1 / 14th Street (0.23 miles from the project). The weekday afternoon/evening northbound route includes a stop at Etheldore Street / Sunshine Valley Road (0.62 miles from the project).

Collectively, these routes operate hourly from 5:30 a.m. to 9:00 p.m. on weekdays and every other hour from 5:13 a.m. to 7:58 p.m. on weekends.

Southbound

The weekday morning southbound route includes a stop at Etheldore Street / Sunshine Valley Road (0.62 miles from the project). The weekday afternoon/evening southbound route stops at State Route 1 / 16th Street (0.11 miles from the project) and California Avenue / Etheldore Street (0.47 miles from the project). Collectively, these routes operate hourly from 6:18 a.m. to 9:50 p.m. on weekdays and every other hour from 6:16 a.m. to 9:28 p.m. on weekends.

Route 18

SamTrans route 18 operates between Main Street / 7th Street in Montara and Moonridge Apartments near Half Moon Bay. The route travels north-south along Sunshine Valley Road and includes stops (in both directions) at Sunshine Valley Road / Etheldore Street (0.47 miles from the project). Route 18 operates two northbound buses in the morning, two northbound buses in the afternoon, three southbound buses in the morning, and two southbound buses in the afternoon.

Transit Service to Schools

SamTrans service would accommodate project students traveling to and from the project to either Manuel F. Cunha Intermediate School via Routes 17 and 18, or Half Moon Bay High School via Route 18.

Transit Stop Access

The nearest Route 17 bus stops are at the following locations:

- **Northbound:** North of the project on the east side of State Route 1 at State Route 1 / 14th Street (0.23 miles from the project). This stop is a widened concrete shoulder with an adjacent paved sidewalk, although there is no sidewalk network or infrastructure to provide walking access to/from the stop.
- **Southbound weekday AM:** South of the project at Etheldore Street / Sunshine Valley Road (0.62 miles from the project). The stop is along a gravel shoulder along Etheldore Street. The stop itself is not connected to any sidewalk network. Sidewalks are provided intermittently in Moss Beach between the Project site and this stop.
- **Southbound weekday PM and weekend:** North of the project on the west side of State Route 1 between Carlos Street and 16th Street (0.11 miles from the project) and at California Avenue / Etheldore Street (0.47 miles from the project). The former transit stop is a pole in an embankment alongside State Route 1 with a few feet of shoulder and is not served by a sidewalk, crossing, or any infrastructure to provide walking access to/from the stop. The latter transit stop is along a gravel shoulder along Etheldore Street. The stop itself is not connected to sidewalk, but a walking path with continuous sidewalk is available between the project site and this stop along Sierra, Stetson, Kelmore, and California Avenue.



**SamTrans Service through Moss Beach
Routes 17 and 18**

**Figure
4**

EXISTING CONDITIONS TRAFFIC VOLUMES

Multimodal traffic volumes, lane configurations, and traffic controls for each study intersection were used to assess the existing conditions LOS and delay. Table 1 shows the findings of this analysis for the AM, PM, and Saturday peak hours. Detailed calculation worksheets showing operations for all intersection movements for the Existing conditions are provided in APPENDIX 3.

Seasonal Adjustment Methodology

Traffic counts were taken in April 2017 while local schools were in session. For traffic volumes along SR 1, Kittelson checked historical traffic counts to see if an upward adjustment would appropriately represent peak summer conditions.⁷

The available data showed the average two-way annual daily traffic volume on SR1 in the project vicinity to be 16,500 vehicles per day and the peak month daily vehicle volume to 17,600 vehicles per day. Kittelson used the ratio between the two (1.07) to inflate the observed April volumes. All analysis traffic volumes for through movements along SR1 were grown by 7 percent. Appendix 2 shows the correspondence with Caltrans on the appropriateness of this method.

Seasonally Adjusted Volumes

The existing intersection geometries and seasonally-adjusted existing volumes are shown in Figure 5 and Figure 6.

Comparison with 2022 Volumes

Traffic volumes were subsequently collected at the same intersections in October 2022 and compared to the (unadjusted) volumes collected for this analysis.⁸

Locations along State Route 1 experienced a decrease in weekday AM traffic of between 15 and 23 percent, a weekday PM decrease of 5 to 9 percent, and a Saturday midday peak hour decrease between 10 and 17 percent from 2017 to 2022. There has been a more significant decrease in travel for northbound Highway 1 than southbound Highway 1 for Saturday peak hour. For weekday afternoon peak hour, northbound travel did not experience a significant change from 2017; however, southbound travel decreased by around 16 percent. Both directions of travel have had significant decreases (14 to 18 percent) in the weekday AM peak hour.

For local roads, the change in peak hour volumes varies by location. Locations along Sierra Street experienced approximately 50 percent higher weekday morning traffic volumes, while evening traffic volumes remained nearly constant, and Saturday midday peak hour increased between 12 and 19 percent. Locations along California Avenue experienced higher traffic volume for all evaluated peak hours, while the intersection of California Avenue and Carlos Street has experienced a decrease in Weekday morning volumes and Saturday peak hour volumes.

In general, the traffic volumes along State Route 1 (which are currently uncontrolled) generally govern the traffic operations: more traffic along the major street makes gap finding more difficult for drivers on a side

⁷ Counts were obtained from the Caltrans Traffic Census Program website. The data used were from 2015 and are available at <https://dot.ca.gov/programs/traffic-operations/census>.

⁸ More detail on these 2022 traffic volumes is available in the *Peer Review of Cypress Point Traffic Impact Analysis and Mitigation Plan* (Fehr & Peers, February 2023).

street with stop control. Therefore, given the decreases along State Route 1, the analysis team determined that the seasonally-adjusted volumes presented in this section are still relevant and appropriate for analysis.

H:\20\20616 - Moss Beach Housing TIA\dwgs\figs\20616_Fig01_revised_for_report.dwg Jan 10, 2018 - 3:02pm - malston Layout Tab, F4 Ex TCDS

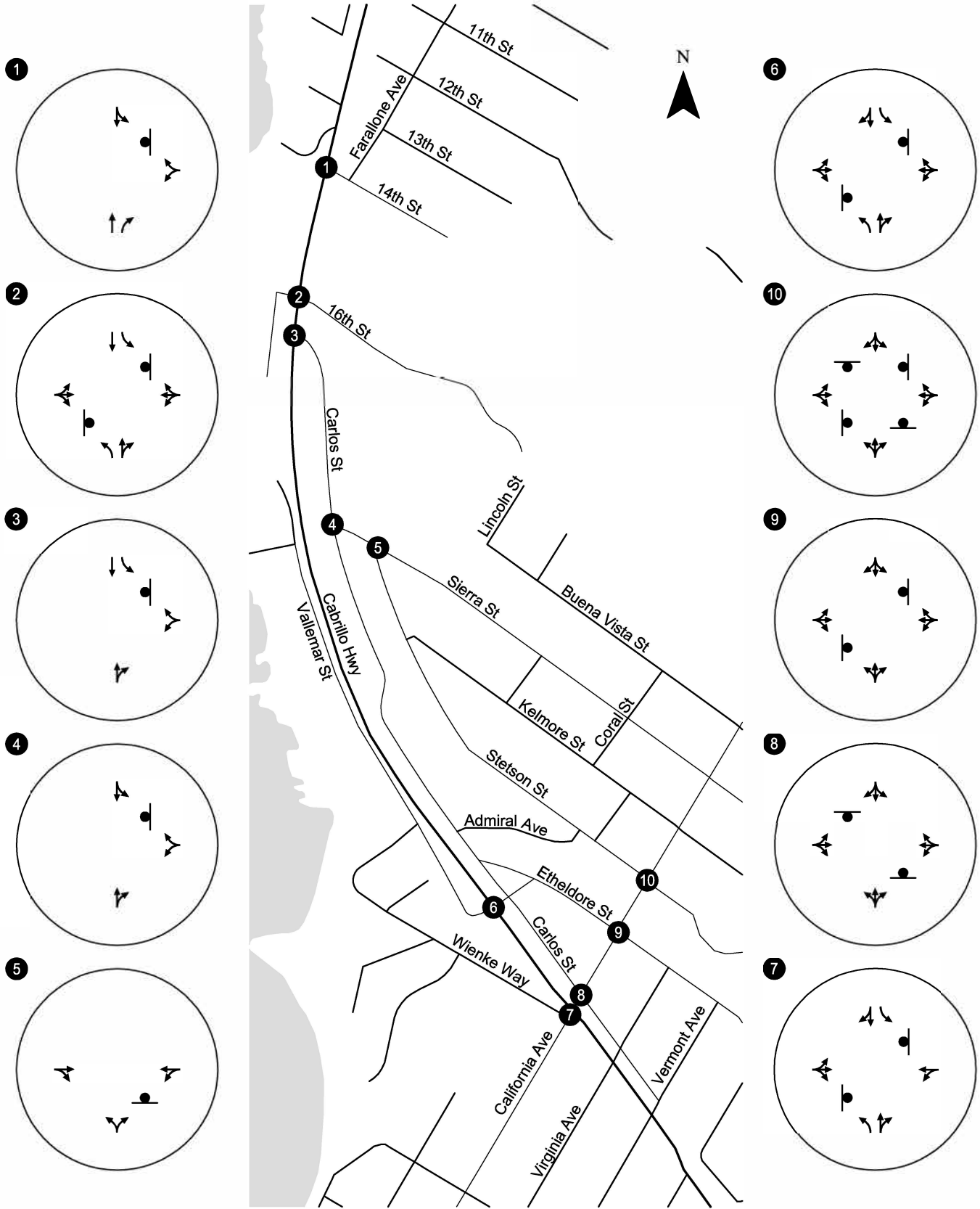

Existing Lane Configurations and Traffic Control Devices Moss Beach, California

Figure 5

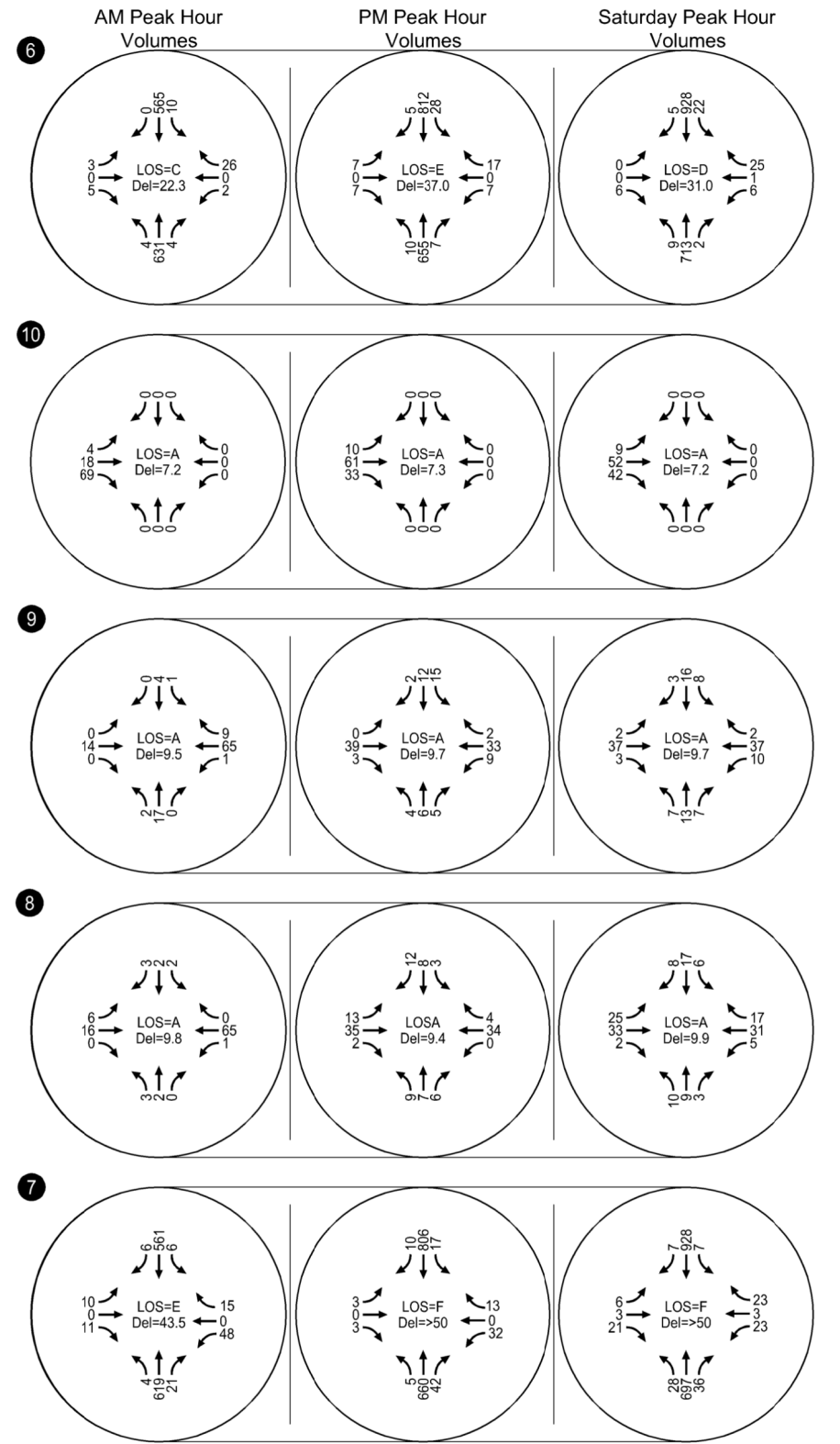
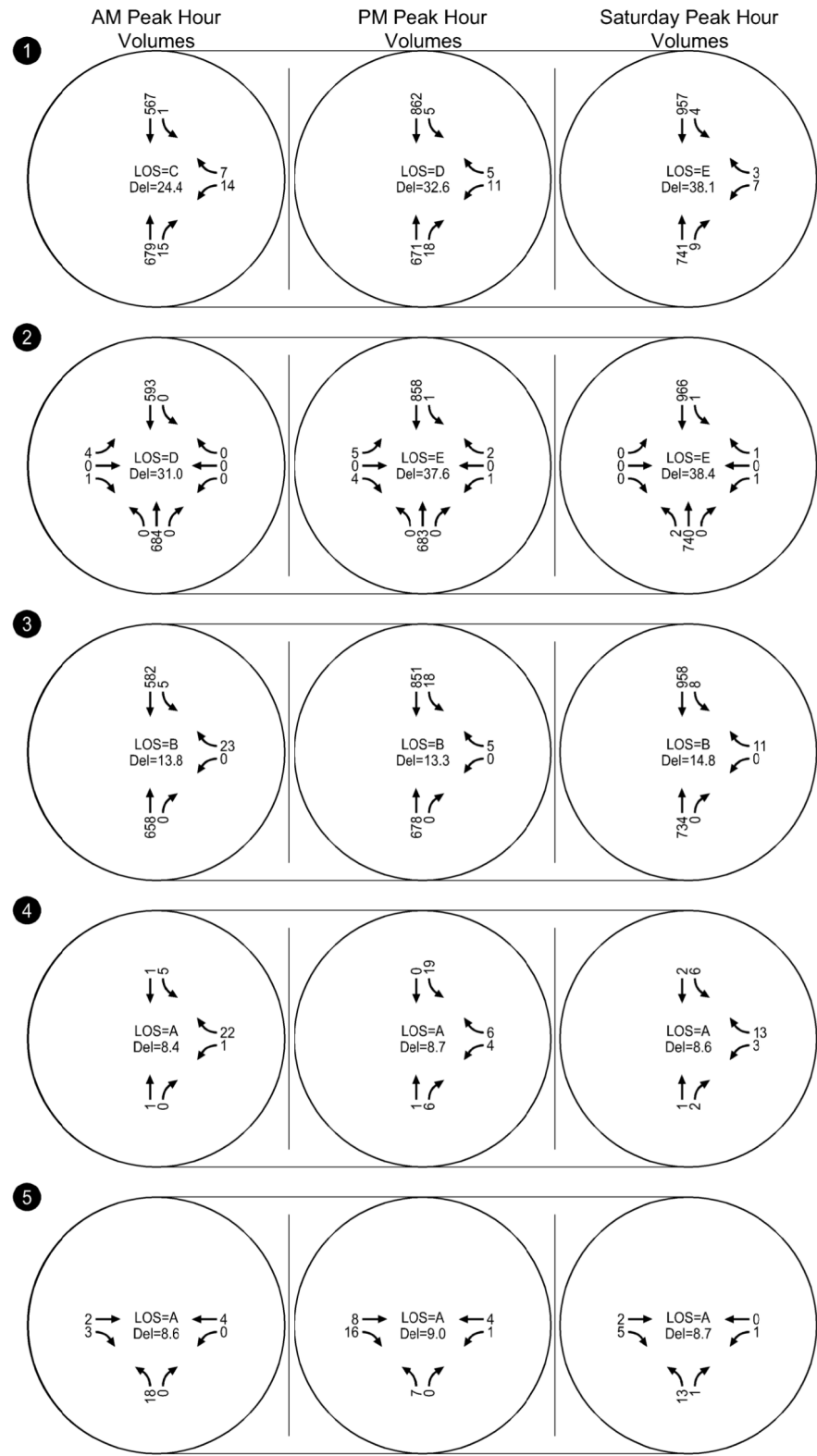
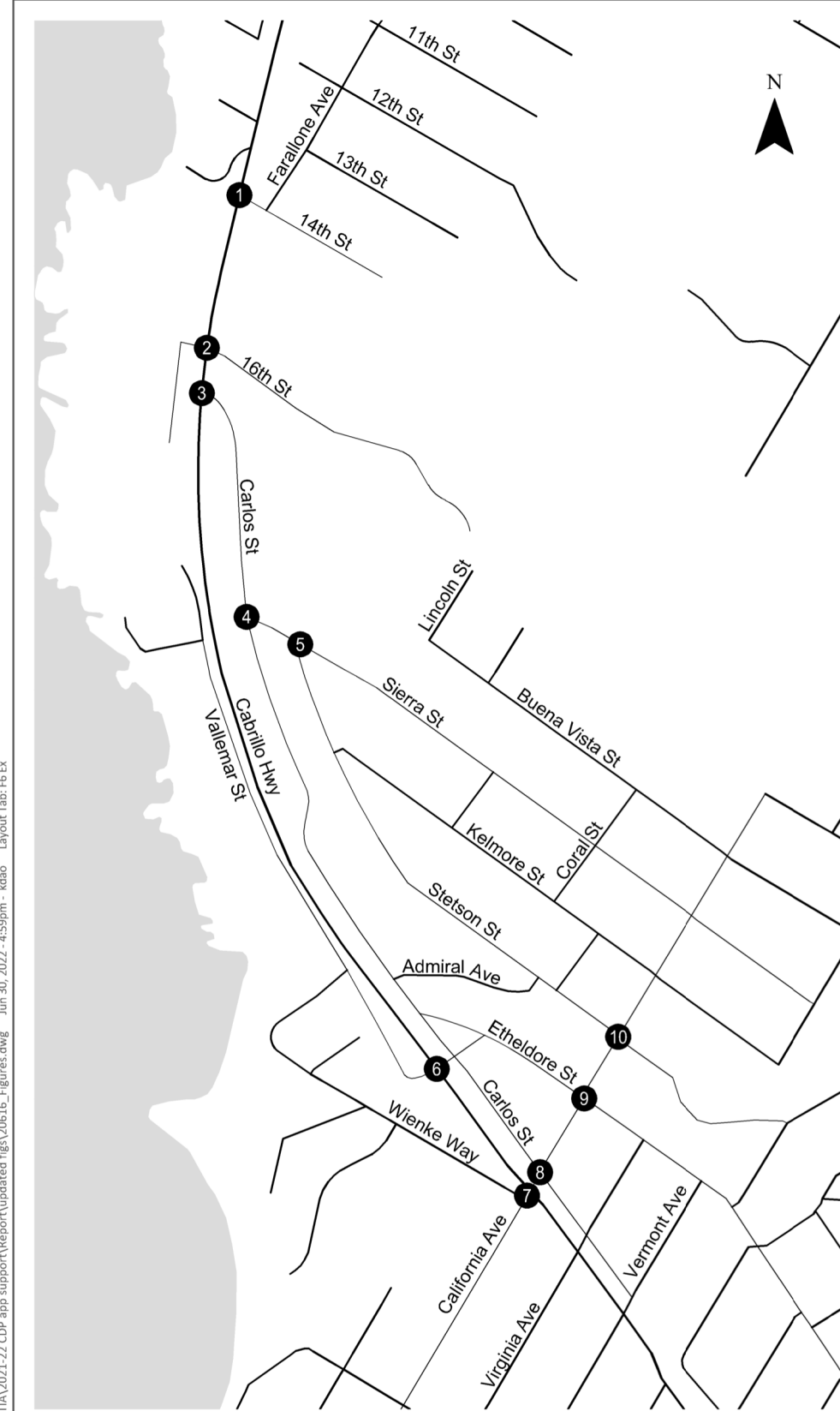

CM = CRITICAL MOVEMENT (UNSIGNALIZED)
 LOS = CRITICAL MOVEMENT LEVEL OF SERVICE (SIGNALIZED)/CRITICAL MOVEMENT LEVEL OF SERVICE (UNSIGNALIZED)
 Del = INTERSECTION AVERAGE CONTROL DELAY (SIGNALIZED)/CRITICAL MOVEMENT CONTROL DELAY (UNSIGNALIZED)
 V/C = CRITICAL CRITICAL VOLUME-TO-CAPACITY RATIO

● - STOP SIGN
 🚦 - TRAFFIC SIGNAL

Existing Peak Hour Turning Movement Volumes and Operations AM, PM, and Saturday Peak Hour Moss Beach, California

Figure 6

H:\2016\2016-16-Moss Beach Housing TIA\2021-22 CDP app support\Report\Updated figs\20616_Figures.dwg Jun 30, 2022 - 4:59pm - kdao Layout Tab: F6 Ex

PROJECT VEHICLE TRIP GENERATION

TRIP GENERATION

Trip generation of the project is based on information compiled in the 9th Edition of the Institute of Transportation Engineers (ITE) *Trip Generation* manual.⁹ The *Trip Generation* manual does not have trip generation data specific to affordable housing but does have several related uses including apartment, low-rise apartment, mid-rise apartment, and high-rise apartment. Of these land uses, the apartment land use (ITE 220) was used for this study because this land use had a larger sample size than the other related uses and had the higher trip generation rates, resulting in a more conservative estimation of trip generation.¹⁰

The trip generation rates used in this study and presented in the *Trip Generation* manual represent suburban or exurban land use contexts with minimal transit service and ridership. In this sense, these rates are suitable for the Moss Beach context. There are a number of transportation demand strategies that could be employed at this site that may reduce the number of trips associated with the project. For example, the project site plan may be designed to promote walking and bicycling, which would help to reduce short vehicle trips. However, some typical strategies may be limited in effectiveness given the land use context and the relatively small size of the project relative to larger employer-based TDM programs. For example, an on-site shuttle would not likely have an obvious nearby destination or route schedule.

As summarized in Table 2, the project would generate 473 daily trips, 37 weekday AM peak hour trips, 45 weekday PM peak hour trips, and 37 weekend Saturday midday peak hour trips. These and all trip numbers in this report describe one-way trips.

Table 2: project Trip Generation

Land Use	ITE Code	Unit	Size	Daily	Weekday AM Peak Hour			Weekday PM Peak Hour			Saturday Midday Peak Hour		
					Total	In	Out	Total	In	Out	Total	In	Out
Apartment	220	Dwelling Units	71	473	37	8	29	45	29	16	37	19	18

Source: ITE *Trip Generation* manual, 9th Edition; Kittelson & Associates, 2022

Although the community center onsite may occasionally be used for public events, it will primarily be used by project residents. Therefore, for the purposes of this analysis, the community center onsite is expected only to generate internal trips, not additional trips from outside the project.

Trip Generation Sources

At the time this analysis was conducted, the 9th Edition was the most current version of the ITE *Trip Generation Manual* and therefore the most appropriate source for trip generation information. ITE has subsequently released several updates and the 11th edition provides a more recently updated source of this information.

⁹ Institute of Transportation Engineers. *Trip Generation*, 9th Edition, Washington, D.C. 2012

¹⁰ The manual lists Land an average rate of 6.65 weekday trips per dwelling unit for land use ITE 220 (Apartment), 6.59 for ITE 221 (low-rise apartment), 4.20 for ITE 222 (High-Rise Apartment), and no reported daily rate for ITE 223 (Mid-Rise Apartment).

A comparison of a few methodologies from the 11th Edition Trip Generation Manual and a comparison of the trip generation rates by each method are presented in **Table 3**.

Table 3. Trip Generation Comparison

	AM Peak Hour			PM Peak Hour			Saturday Peak Hour			Number of Studies
	Trips	In	Out	Trips	In	Out	Trips	In	Out	
TIA Trip Generation – ITE 9 th Edition ¹	37	8	29	45	29	16	37	19	18	AM: 78 PM: 90 Saturday: 14
ITE 11 th Edition – Multi-Family Low-Rise ²	45	11	34	51	32	19	29	15	14	AM: 49 PM: 59 Saturday: 1
ITE 11 th Edition – Affordable Housing ³	32	9	23	41	24	17	91	46	45	AM: 6 PM: 8 Saturday: 1

Notes:

1. ITE Trip Generation, 9th Edition (Land Use #220 – General Apartment) Adjacent Street Traffic Peak Hour, Linear equation
2. ITE Trip Generation, 11th Edition (Land Use #220 – Multi-Family Low-Rise) Adjacent Street Traffic Peak Hour, Fitted Curve Equation
3. ITE Trip Generation, 11th Edition (Land Use #223 – Affordable Housing) Adjacent Street Traffic Peak Hour, Fitted Curve Equation

Source: Fehr & Peers, 2022.

Based on the table, the 9th Edition rates are satisfactory for the analysis approach. The appropriate land use in 11th Edition shows slightly higher trip generation rates in the weekday AM and PM Peak Hours compared to the 9th Edition land uses (ranging from 13 to 22 percent) and lower Saturday peak hour trips. In contrast, the affordable housing land use in the 11th edition shows the opposite – fewer weekday AM and PM peak hour trips and drastically higher Saturday trips. (Both 11th edition Saturday observations are based on a single observation and should therefore not be used for this analysis.)

The Affordable Housing land use rates are based on a low number of observations (6 and 8 respectively) so may not necessarily be appropriate to use here. However, combined with other evidence that residents of affordable housing typically drive less (i.e., generate fewer driving trips) than market-rate residents, the 9th Edition rates already used appear to be appropriate in comparison to more recent data.¹¹ The trip generation analysis is based on the 9th Edition rates.

TRIP DISTRIBUTION AND ASSIGNMENT

The distribution of project trips was derived from existing travel volume data and from knowledge of local travel times. The recorded north/south distribution of traffic along State Route 1 was used to inform the direction that project traffic would be going to or coming from in order to access the project site. Access to State Route 1 from the project was assumed to be via the Carlos Street and State Route 1 intersections. The trip distribution is shown in Table 4. project only trips are shown in Figure 7.

¹¹ The CAPCOA Handbook for Analyzing Greenhouse Gas Emission Reductions, Assessing Climate Vulnerabilities, and Advancing Health and Equity provides information on affordable housing in relation to driving and vehicle miles traveled production. It is available online at <https://www.airquality.org/businesses/ceqa-land-use-planning/ghg-handbook-caleemod>.

Table 4: project Trip Distribution along State Route 1

To/From project	Direction Along State Route 1	Weekday AM Peak Hour	Weekday PM Peak Hour	Saturday Midday Peak Hour
Outgoing (from project)	Northbound	52%	44%	44%
	Southbound	48%	56%	56%
Incoming (to project)	Northbound (from South)	50%	55%	58%
	Southbound (from North)	50%	45%	42%

Outgoing and incoming trips from each time period sum to 100%.

Source: Kittelson & Associates, 2022.

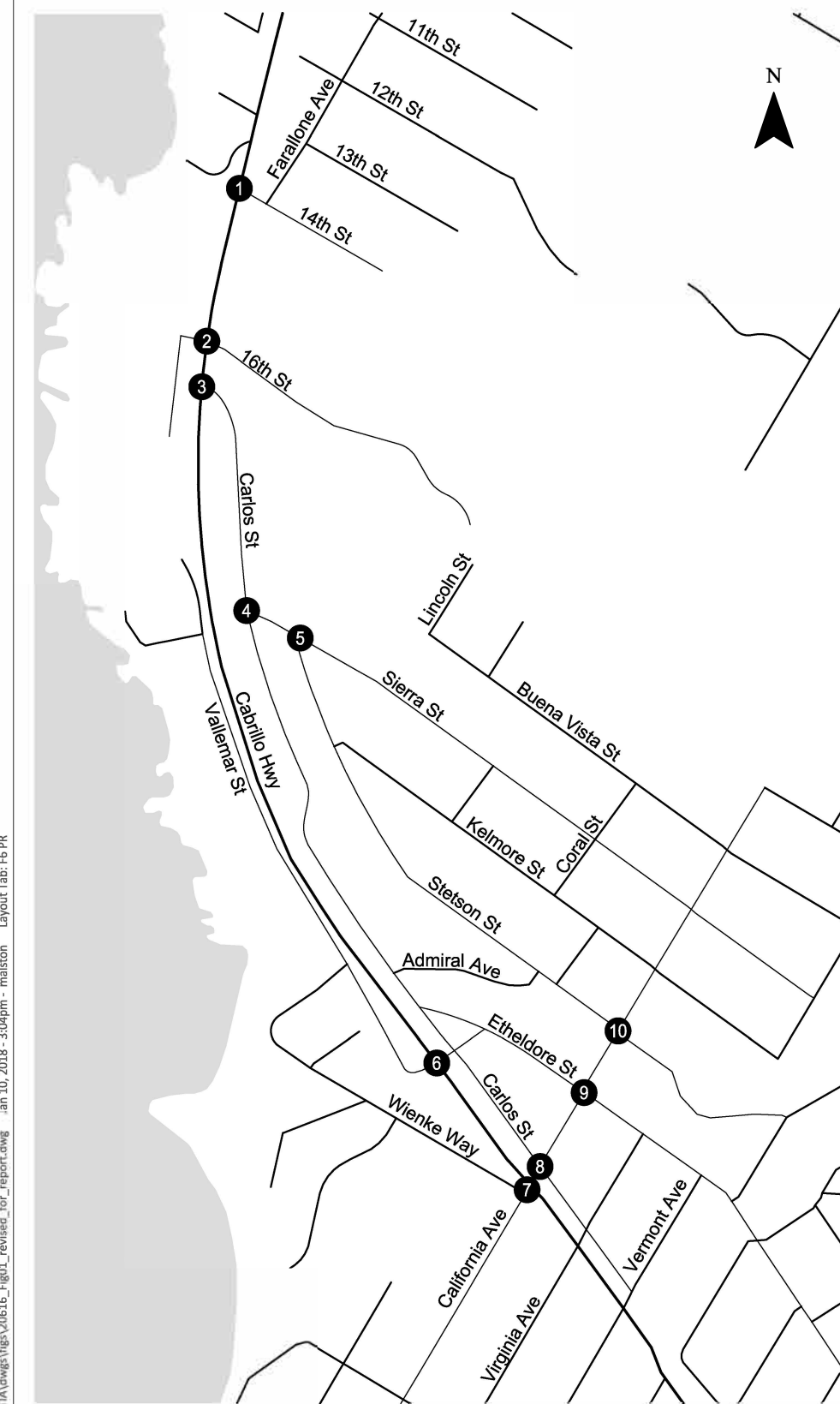

CM = CRITICAL MOVEMENT (UNSIGNALIZED)
 LOS = CRITICAL MOVEMENT LEVEL OF SERVICE (SIGNALIZED)/CRITICAL MOVEMENT LEVEL OF SERVICE (UNSIGNALIZED)
 Del = INTERSECTION AVERAGE CONTROL DELAY (SIGNALIZED)/CRITICAL MOVEMENT CONTROL DELAY (UNSIGNALIZED)
 V/C = CRITICAL CRITICAL VOLUME-TO-CAPACITY RATIO

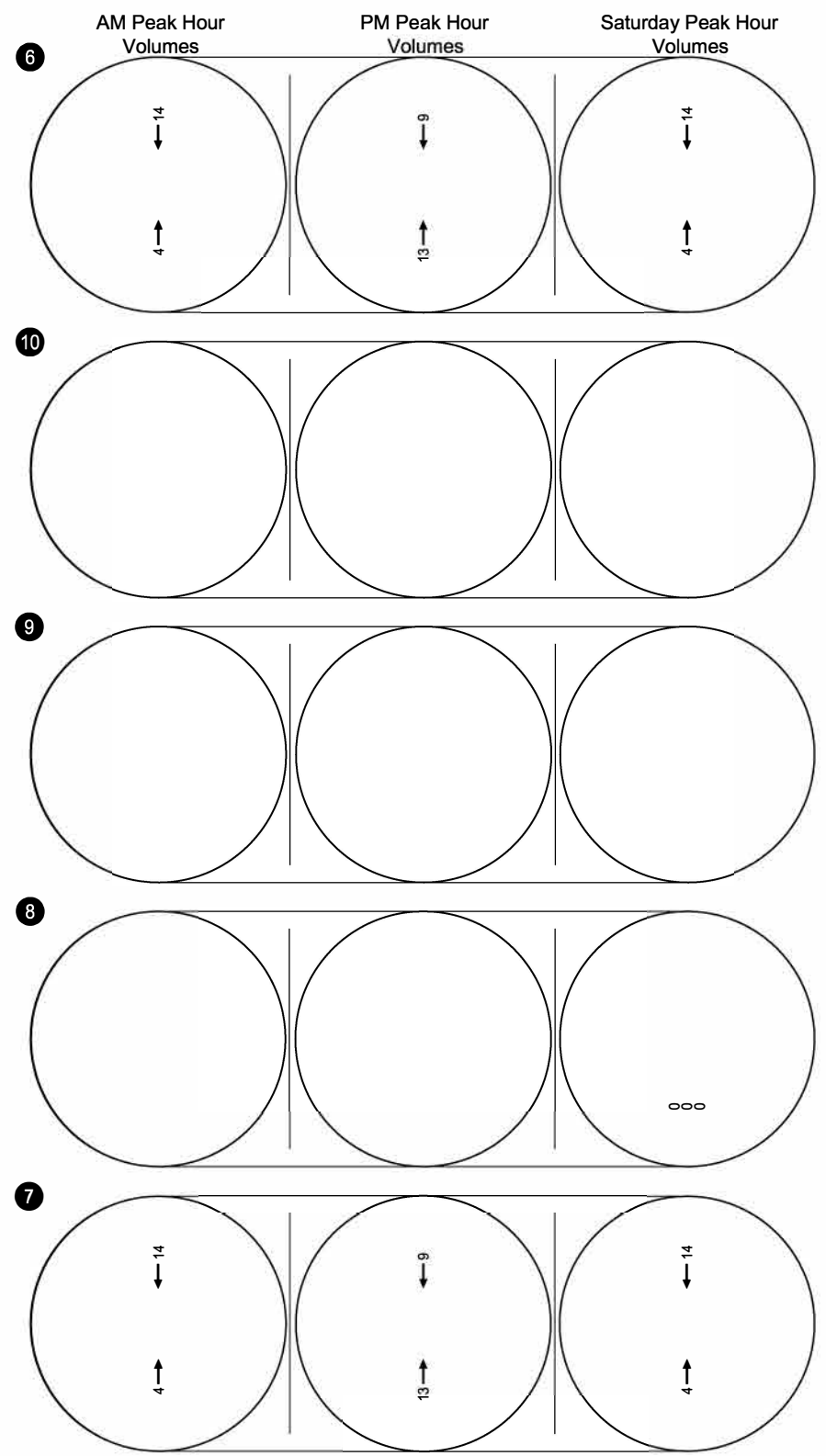
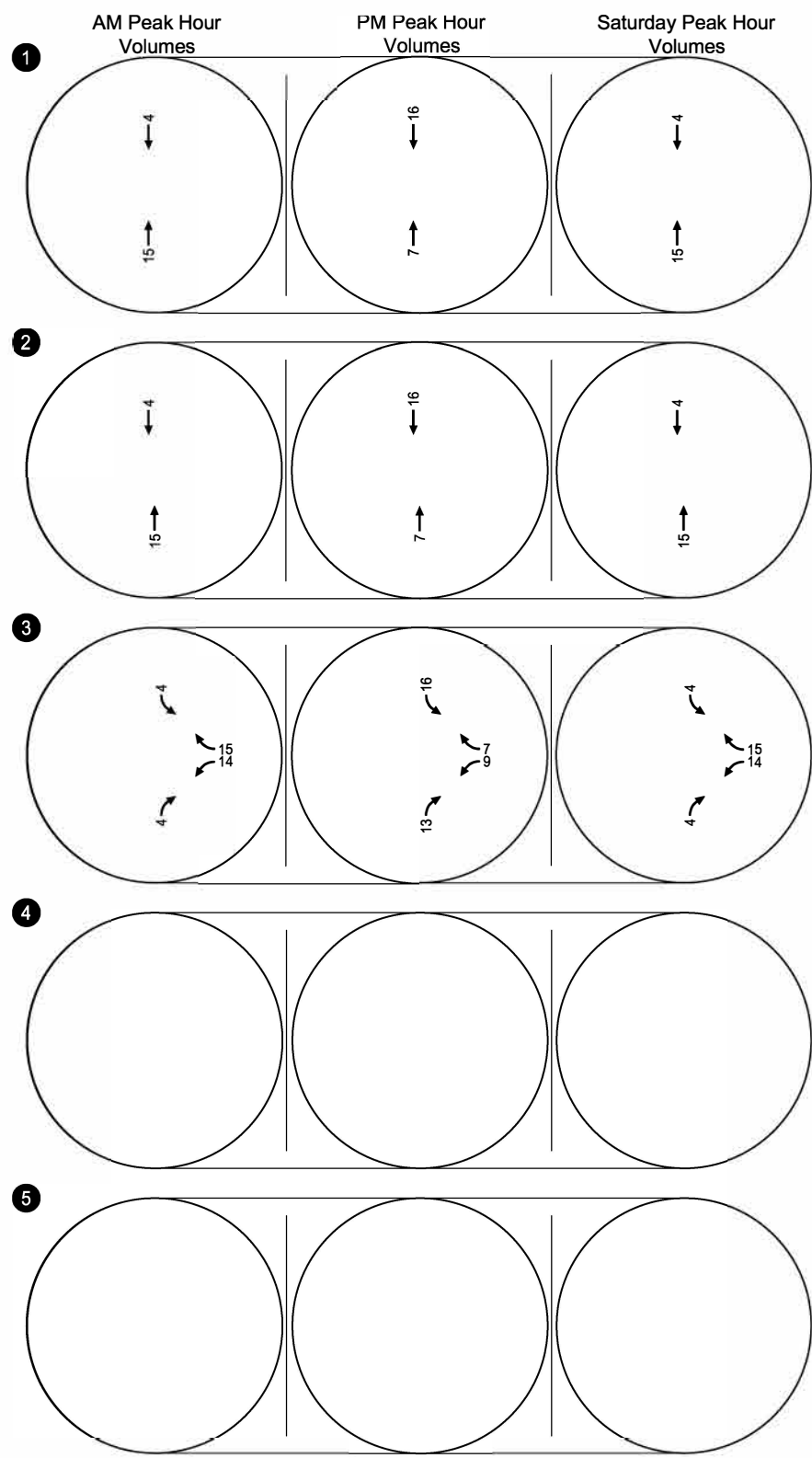

Project Turning Movement Volumes
 AM, PM, and Saturday Peak Hour
 Moss Beach, California

Figure
 7

VMT ANALYSIS

As described in the *Data Analysis and Approach* section of this report, the project would represent a significant impact if it project would result in more than 11.56 daily home-based VMT per capita by residence. (This represents a 15% reduction from the baseline County average of 13.60 home-based trip VMT per resident.) It will be exempt from detailed VMT analysis if it meets County screening criteria.

One such screening criterion is for projects that provide 100% affordable housing. Per the County's Interim VMT Analysis Criteria¹² for Affordable Housing, projects that generate 100% affordable housing in infill areas typically generate lower VMT than market-rate housing.

The site is defined as infill and medium density residential in the LCP (see Figure 8) and designated as a priority development site for affordable housing in the San Mateo County Local Coastal Program Policies document (San Mateo County Planning and Building Department 2013). The site is also designated as an affordable housing opportunity site under the San Mateo County Housing Element. (San Mateo County Planning and Building Department 2015).

The C/CAG VMT Estimation Tool shows that the average residential VMT for the Project area is 23.6 daily miles per capita. Using the 2020 baseline year, the Bay Area Regional Average home-based VMT per resident is 14.6, and a 15% reduction from the baseline County average would result in a threshold of 12.41 home-based VMT per resident.

As part of subsequent environmental review, the County may determine whether to rely on the screening option (which would assume a less-than-significant impact) or a more quantitative approach to VMT analysis. The latter may result in a **significant impact**, pending further analysis.

¹² "Change to Vehicle Miles Traveled as Metric to Determine Transportation Impacts under CEQA Analysis", Department of Public Works, County of San Mateo. September 2020.

Figure 8: Midcoast Land Use Plan Zoning

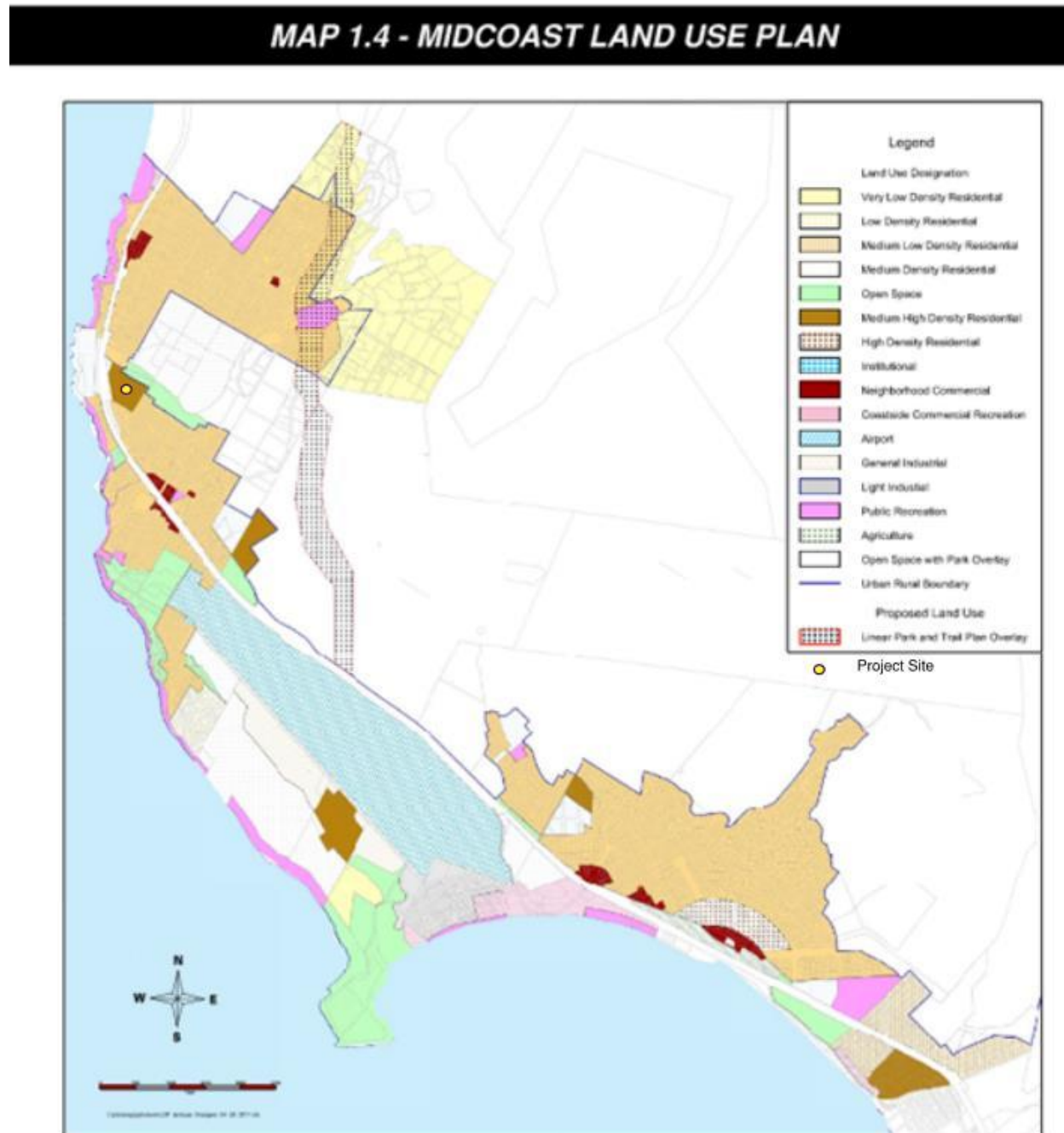

Source: San Mateo County Midcoast Land Use Area Plan



Site Access, Circulation & Parking

SITE ACCESS, CIRCULATION & PARKING

This section analyzes project site access, circulation, and parking. The project site would include a driveway along Carlos Street and 142 vehicle parking spots, with 5 electric vehicle parking spots in a loop surface parking lot.¹³ The site would include racks providing for eight short-term bicycle parking spaces and 36 long-term (i.e., indoors, and secure) bicycle parking spaces. The project does not propose to provide any off-site vehicle or bicycle parking.

PARKING ASSESSMENT

This section evaluates the adequacy of parking for the project using two methods. It is first evaluated against San Mateo County zoning regulations on parking. It is also evaluated against parking demand, as estimated based on industry standards. Based on County zoning regulations, a 71-unit apartment complex is required to have 127 parking spaces as shown in Table 5. Therefore, the project provides 15 more parking spaces than required by San Mateo County.

Table 5: Parking Requirements for the project

Apartment Type	Number of Units	Parking Rate (Per Unit)	Parking Required
1 Bedroom	16	1.2	20
2 Bedroom	37	1.5	56
3 Bedroom	18	2	36
Guest Parking ¹		0.2	15
Total:			127

¹Guest parking at 1 space per 5 units

Source: Kittelson & Associates, Inc. 2018; San Mateo County Zoning Regulations Chapter 3, Section 6119

An estimate of parking demand was performed using the *Parking Generation Manual* (4th edition) published by the Institute of Transportation Engineers (ITE). This manual is a standard transportation industry document that estimates the demand for parking based on studies conducted at similar sites. The land use in the ITE manual that is the most similar with the project is the Low/Mid-Rise Apartment (LU 221) since the Apartment (LU 220) is not available.

Based on the demand rates from previous studies compiled in the ITE Manual, the average demand for a 71 unit apartment complex would be about 88 parking spaces while the maximum observed demand would be about 138 parking spaces, as shown in Table 6. This demand includes demand from any guests as well as residents. With a parking supply of 142 spaces, the project is anticipated to have about 4 more parking spaces than the anticipated maximum demand.

Using both criteria, the amount of parking contained in the project is adequate to meet the demand.

¹³ This number may change as required by updated code requirements; the project sponsor will coordinate with the County on any changes to requirements and required project description changes.

Table 6: Average Estimated Parking Demand for the project

Parking Demand	Number of Units	Demand Rate ¹	Parking Spaces Needed
Average	71	1.23	88
Maximum Observed		1.94	138

Source: Kittelson & Associates, Inc.

Demand based on ITE Parking Generation Manual, 4th Edition (LU 221)

¹Demand rate in vehicles per apartment

ELECTRIC VEHICLE PARKING

Electric vehicle (EV) parking requirements are determined by the California Green Building Code¹⁴, which was updated in 2022. The code requires 10 percent of spaces (15 total for this project) be EV-capable, 25 percent be equipped with low power charging receptacles (36 total for this project), and 5 percent be equipped with Level 2 EVSE (8 total for this project).

The project provides 5 parking spaces equipped with electric vehicle charging stations, which does not meet the CalGreen requirements. It is recommended that the project increase the number of EV parking spaces to meet CalGreen requirements. The project sponsor has indicated plans to update the project plans to comply with these requirements.

EMERGENCY ACCESS

Emergency access to the project would be provided by the driveway on Carlos Street. Additionally, there is an emergency vehicle access route provided from Lincoln Street. Given the two access points available for emergency vehicle ingress and egress, the project's proposed site plan is expected to provide adequate emergency vehicle access. This analysis assumes that the final design of all circulation improvements shall be required to adhere to all applicable County and other statutes and requirements, including, without limitation, those set forth in the California Fire Code and California Vehicle Code. Therefore, the project does not have an impact on emergency access.

PEDESTRIAN & BICYCLE ACCESS

Bicycle Access

A qualitative assessment was conducted to determine the project's potential impacts on bicyclists and bicycle facilities. San Mateo County's Bicycle and Pedestrian Master Plan (2011) includes planned Class I, Class II, and Class III bikeways in the vicinity of the project. These facilities include:

- Class I multi-use path near State Route 1 between Carlos Street and Main Street
- Class II bicycle lane along Carlos Street
- Class III bicycle route along State Route 1

The project does not conflict with existing or proposed bicycle facilities identified in the Bicycle and Pedestrian Master Plan because the project is not proposing to change roadway geometries in ways which would prevent the development of the proposed bicycle facilities. Therefore, the project does not have an impact on bicycle access.

¹⁴ UpCodes. 2022. California Green Building Standards Code 2022. Available: <https://up.codes/viewer/california/ca-green-code-2022/chapter/4/residential-mandatory-measures#4.106.4>. Accessed December 5, 2022.

Pedestrian Access to Transit

The project may lead to an increase in pedestrians accessing the nearest bus stop which is located across State Route 1 near Carlos Street. This stop serves Route 17 for the weekday PM and weekend service, but there is no marked crosswalk across State Route 1 to access it. Additionally, there is inadequate corner sight distance at the intersection of Carlos Street and State Route 1 for pedestrians to see vehicles and drivers to see pedestrians.

The *Connect the Coastside* study, which was prepared by San Mateo County to evaluate transportation needs in this area, has proposed a change of traffic control at State Route 1 and 16th Street/Carlos Street in the vicinity of the southbound bus stop based on established needs. The County has subsequently initiated a PID to study such a change and is coordinating with Caltrans. Any such project would need Caltrans approval and therefore does not rest within the County's exclusive control.

Since the project will likely increase the pedestrian demand for crossing State Route 1 at an unmarked crossing location with inadequate sight distance, the project will increase the hazard for this crossing, resulting in an impact.

Pedestrian Access to Sidewalk Network

The proposed access driveway for the project is on Carlos Street, which does not provide pedestrian facilities such as sidewalks to connect the project to sidewalks on the north side of Sierra Street and the east side of Stetson Street. Since the project is anticipated to house more than 200 residents, it is likely to increase pedestrian activity in the area. Without a proper connection to the sidewalks on Sierra Street and Stetson Street, project residents would need to walk in the street, resulting in the potential for decreased pedestrian safety. Therefore, the impact is considered to be an impact.

Transit Service

The project site is served by two bus routes (Route 17 and Route 18) operated by SamTrans transit service (see Figure 4). The nearest Route 17 bus stops are at the following locations:

- Northbound: North of the project on the east side of State Route 1 at State Route 1 / 14th Street (0.23 miles from the project). This stop is a widened concrete shoulder with an adjacent paved sidewalk, although there is no sidewalk network or infrastructure to provide walking access to/from the stop.
- Southbound weekday AM: South of the project at Etheldore Street / Sunshine Valley Road (0.62 miles from the project). The stop is along a gravel shoulder along Etheldore Street. The stop itself is not connected to any sidewalk network. Sidewalks are provided intermittently in Moss Beach between the Project site and this stop.
- Southbound weekday PM and weekend: North of the project on the west side of State Route 1 between Carlos Street and 16th Street (0.11 miles from the project) and at California Avenue / Etheldore Street (0.47 miles from the project). The former transit stop is a pole in an embankment alongside State Route 1 with a few feet of shoulder and is not served by a sidewalk, crossing, or any infrastructure to provide walking access to/from the stop. The latter transit stop is along a gravel shoulder along Etheldore Street. The stop itself is not connected to sidewalk, but a walking path with continuous sidewalk is available between the project site and this stop along Sierra, Stetson, Kelmore, and California Avenue.

The nearest Route 18 bus stops in both directions are at Sunshine Valley Road / Etheldore Street (0.47 miles from the project).

Both of these routes primarily travel along State Route 1. Since the majority of State Route 1 traffic movements experience little or no delay, the project traffic is not anticipated to decrease the performance of public transit.

SPEED LIMITS AND SIGHT DISTANCE

The conceptual site plan for the project was reviewed to assess potential hazards due to project design or operations and potential incompatible land uses. The proposed land uses are generally compatible with existing uses in the project vicinity and would not result in undue hazards. Therefore, this assessment focuses on potential hazards due to design. The design topic considered was the project's impact on intersections with restricted sight distance for existing operating speeds per Caltrans *Highway Design Manual* standards.

Kittelson reviewed the study intersections that access State Route 1 to determine if any of these have restricted sight distance that does not meet Caltrans standards. The intersection of State Route 1 and Carlos Street was found to provide 305 feet of sight distance to the south, which is 246 feet less than what is required for an intersection with a 50-mph facility such as State Route 1, per Table 405.1A in the Caltrans *Highway Design Manual*.¹⁵

Additionally, a two-way left turn lane is present along State Route 1 exclusively between Carlos Street and 16th Street. Considering the need for deceleration before making a left turn from State Route 1 to either street, motorists making northbound left turns to 16th Street and those making southbound left turns to Carlos Street represent overlapping and conflicting uses of the lane. The addition of southbound left-turning project traffic from State Route 1 to Carlos Street would further contribute to potential conflict between the two movements.

Because this intersection would serve as the principal means of access for the project to and from State Route 1, the project would add traffic to both the movements with restricted sight distance and the overlapping left turns, resulting in a sight distance-related project impact.

¹⁵ Note that the applicable section of State Route 1 has a posted speed limit of 45 miles per hour, which would indicate a design speed of 55 miles per hour, which is the applicable standard for corner sight distance per the Caltrans *Highway Design Manual*.



Conclusions and Mitigation Measures

CONCLUSIONS AND MITIGATION MEASURES

This section presents project-related impacts identified in this report and proposed mitigation measures to offset new vehicle trips generated by the project to the extent feasible.

VEHICLE MILES TRAVELED

As part of subsequent environmental review, the County may determine whether to rely on a potential screening option to evaluate the project's vehicle miles traveled (which would assume a less-than-significant impact) or a more quantitative approach to VMT analysis. The project may result in a significant impact, pending further analysis.

SIGHT DISTANCE AND SAFETY IMPACTS

Sight distance and safety impacts were identified related to the following.

Impact T-1: The project would substantially increase hazards by adding vehicle trips to an intersection with existing deficient sight distance (State Route 1 & Carlos Street [#3]).

The project would add traffic to the westbound approach at the intersection of Carlos Street and State Route 1, which has inadequate sight distance for seeing northbound vehicles on State Route 1. It would also cause potential conflict between project trips making a southbound left onto Carlos Street and non-project traffic making a northbound left into the Lighthouse since both movements share a very short left turn lane. This would cause a significant impact under all Project scenarios.

This intersection provides primary access to the project site from State Route 1. Project vehicles would have restricted sight distance when exiting onto State Route 1 making it difficult to judge adequate gap acceptance for safe entry onto State Route 1. To reduce this impact, implement the following mitigation measures.

Mitigation Measure T-1: Provide Additional Transportation Demand Management (TDM) Measures

The project includes a TDM plan (described in the Project Description section and in more detail in the checklist included in Appendix 9), which can be expected to reduce project trips.

As a mitigation measure, the project shall also construct sidewalk, crosswalk, bicycle route, and transit infrastructure improvements that would improve conditions within Moss Beach for pedestrians and bicyclists. The additional measures will include:

- **Carlos Street:** Add sidewalks on Carlos Street from the project entrance to Sierra Street.
- **Sierra Street:** Clear/plane existing sidewalk that fronts project site on Sierra Street from Carlos Street to Stetson Street.
- **Sierra Street/Stetson Street:** Add high visibility crosswalks with advanced yield markings and yield signs for pedestrians to cross Sierra Street to Stetson Street on the southeast corner. Add 1-way stop on northbound Stetson Street.
- **Stetson Street/Kelmore Street:** Add ramp with truncated domes on the northeast corner if feasible with fire station configuration and drainage. Add high-visibility crosswalk to cross Kelmore Street.
- **Stetson Street/California Avenue:** Add high-visibility crosswalk with advanced stop bar to cross Stetson Street (from northeast corner to northwest corner toward Etheldore Street).

- **California Avenue/Etheldore Street:** Add high-visibility crosswalks with advanced stop bars to access bus stops on the southeast and northwest corners.
- **California Avenue, south of Etheldore Street:** Add sidewalk on west side of California Avenue where missing to connect to downtown Moss Beach.
- Contributions toward accessible bus stops at **California Avenue / Etheldore Street** if feasible, including providing bus benches.
- Assist in implementation of the planned Class III Bikeways (per draft Unincorporated San Mateo County Active Transportation Plan) by providing sharrows on **Sierra Street between project site and California Avenue**, and on **California Avenue between Sierra Street and Carlos Street**.

Although a TDM plan and these additional measures would reduce the vehicle trip generation by promoting alternative modes of travel and lessen the impact, the effectiveness of a TDM plan cannot be guaranteed. Therefore, the impact remains.

Mitigation Measure T-2: Close Carlos Street between State Route 1 and the project to all but emergency vehicles.

The removal of traffic from this intersection would negate the need for improving intersection sight distance since drivers would no longer be allowed to turn onto or off of Carlos Street at this location. Project vehicle trips as well as existing trips at the intersection would instead be routed south along Carlos Street and Stetson Street to access State Route 1 at either Etheldore Street or California Avenue.

At the time of this writing, the County is working on a Caltrans Project Initiation Document (PID) as part of the Moss Beach State Route 1 Congestion & Safety Improvements Project. With this project, the County will determine feasibility for a traffic signal and roundabout at a combined State Route 1 / 16th Street / Carlos Street intersection. The County is working with Caltrans, but funding has not yet been identified. Implementation authority rests jointly with the County and Caltrans and is therefore out of the County's exclusive control. The closure recommended in this mitigation measure can therefore be considered a temporary solution intended to mitigate the identified impact until the County can successfully implement a change of traffic control. That future project would be consistent with Caltrans design standards, provide adequate sight distance for the resulting condition.

Additional Mitigation Measures

Two additional potential mitigation options were considered but rejected in favor of Mitigation Measure T-2.

- **Connecting Carlos Street with 16th Street instead of State Route 1.** In field review, 16th Street was found to provide sufficient corner sight distance. This option would reroute Carlos Street at State Route 1 into 16th Street instead, directing all inbound and outbound Carlos Street traffic to 16th Street. However, this option was considered infeasible for the following reasons:
 - A "Tee" intersection of 16th Street and Carlos Street in close proximity (less than one car length) to the existing stop-controlled intersection between State Route 1 and 16th Street would have the potential to create conflicts between vehicles turning from State Route 1 onto 16th Street and vehicles turning from Carlos Street onto 16th Street, especially given a difference in operating speeds for motorists turning from the highway compared to motorists driving along Carlos Street. In order to avoid conflicts, the County could need to obtain additional right of way to increase the distance between State Route 1 and a potential Carlos Street/16th Street intersection.
 - There is a notable grade difference between Carlos Street and 16th Street and providing a formal connection may not be reasonable geometrically. In order to create a reasonable grade for such a connection, the County would potentially need to obtain additional right of way.

This option is the recommendation provided in the *Connect the Coastside* report, but feasibility and implementation concerns are being assessed as part of the project described above.

- **Grading the east side of State Route 1 to provide clear sight distance.** Given speeds along State Route 1, earthwork or tree clearing would be necessary to clear required sight distance to the south at Carlos Street. This would include cutting back trees and re-grading the berm between Highway 1 and Carlos Street. While clearing the land would provide adequate sight distance for the horizontal curvature of the road (see Figure 1), there is also a vertical curve due to elevation changes that may obstruct sight distance. Because Highway 1 crests south of the Carlos Street intersection, a driver may not be able to see vehicles on the other side of the crest of the curve. A detailed topographic map would be needed to determine if horizontal clearing, which may be prohibitively expensive and would require an encroachment permit from Caltrans, would provide adequate sight distance given the vertical curve.

Impact Conclusion

With the implementation of the recommended mitigation measures, the project impact would be reduced to **less than significant with mitigation**. Closing the intersection to general purpose traffic would eliminate the need to provide sight distance at the subject intersection. The project described above that is currently in the PID phase could successfully mitigate the impact as well. As described, it would require successful completion of the study, acquisition of project funding, and concurrence with Caltrans on a change of control at the intersection.

Impact T-2: The project may lead to an increase in pedestrians crossing State Route 1.

The increase in transit ridership expected as a result of the project may lead to more pedestrians crossing State Route 1 to access the bus stop on southbound State Route 1 at 16th Street. This may increase the potential risk for pedestrian/vehicle interactions on State Route 1 given that there are currently no marked pedestrian crossings across State Route 1 near Carlos Street to access this stop. Additionally, the limited sight distance at this location would not allow sufficient visibility for pedestrians to be seen by vehicles on State Route 1.

The proposed TDM plan would include the "M2 – Orientation, Education, Promotional Programs and/or Materials" measure. This measure offers new residents orientation and educational materials or programs. The educational material should include information on SamTrans routes and would direct project residents to use the bus stop at Etheldore Street and California Street instead of crossing SR1 for the same bus lines.

Implementing TDM strategies may introduce offsetting effects with respect to people crossing State Route 1 on foot. Some TDM strategies are aimed at reducing the overall need for travel (for example, by providing improved delivery services onsite to reduce the need for additional shopping trips). However, other strategies are aimed at shifting driving trips to alternative modes of travel (walking, biking, and riding transit). So, in aggregate, TDM strategies may simultaneously increase and reduce the demand for people crossing State Route 1 and cannot be guaranteed to mitigate this impact.

To reduce this impact, implement the following mitigation measures.

Mitigation Measure T-1: Provide Additional TDM Measures

In addition to the project's TDM plan, the project shall also construct sidewalks, crosswalk, bicycle route, and transit infrastructure improvements that would improve conditions within Moss Beach for pedestrians and bicyclists. These improvements would increase the propensity for residents to walk to and from the bus stop at California Avenue / Etheldore Street in Moss Beach but will not guarantee a reduction in the risk of people crossing to get to the bus stop on SR 1.

Other Mitigation Measures

The *Connect the Coastside* report recommends a change of control at State Route 1/Carlos Street (with a preliminary recommendation for a roundabout). This recommendation would provide an opportunity to include a pedestrian crossing alongside traffic control to give a safe crossing of SR1. As previously mentioned, the County is working on a Caltrans Project Initiation Document (PID) as part of the Moss Beach

State Route 1 Congestion & Safety Improvements Project. With this project, the County will determine feasibility for a traffic signal and roundabout at a combined State Route 1 / 16th Street / Carlos Street intersection. The County is working with Caltrans, but funding has not yet been identified. Implementation authority rests jointly with the County and Caltrans and is therefore out of the County's exclusive control.

A change of traffic control on SR1 is not exclusively within the County's control; it would require Caltrans concurrence.

Impact Conclusion

For reasons stated above, with the implementation of the recommended mitigation measures, the project impact would remain **significant and unavoidable**. The County project described above that is currently in PID phase could successfully mitigate the impact but as described would require successful completion of the study, acquisition of project funding, and concurrence with Caltrans on a change of control at the intersection.

Impact T-3: The project will increase walking along Carlos Street and to Moss beach where sidewalks gaps would increase pedestrian/vehicle interactions in the roadway.

To reduce this impact, implement the following mitigation measure.

Mitigation Measure T-1: Provide Additional Transportation Demand Management (TDM) Measures

In addition to the TDM elements required as part of the C/CAG TDM Checklist (included as Appendix 9), the project would also construct sidewalk, crosswalk, bicycle route, and transit infrastructure improvements described on page 37 that would improve conditions within Moss Beach for pedestrians and bicyclists.

Implementation of Mitigation Measure T-1 would improve pedestrian safety and separate people walking from motor vehicles and thereby promote a more welcoming walking environment while reducing the potential for pedestrian/vehicle interactions.

Impact Conclusion

For reasons stated above, with the implementation of the recommended mitigation measures, the project impact would be reduced to **less than significant with mitigation**.



Local Circulation and Traffic Operations

LOCAL CIRCULATION AND TRAFFIC OPERATIONS

This section described the local circulation and operational analysis conducted for informational purposes. Traffic Operations are compared to the LCP Policy 2.44 level of service standard previously described.

EXISTING CONDITIONS

For operational analysis, the existing conditions were analyzed based on the traffic volumes and conditions described in the Existing Conditions section on page 18.

EXISTING NO PROJECT CONDITIONS

As the table shows, Intersection **#7 State Route 1 & California Avenue/Wienke Way** operates below the standard in the weekday AM, weekday PM, and Saturday midday peak periods, and Intersections **#2 State Route 1 & 16th Street** and **#6 State Route 1 & Vallemar Street / Etheldore Street** operate below the standard in the weekday PM.

Table 7: Existing Conditions Intersection Operations Results

No	Location	Control	Existing Weekday AM		Existing Weekday PM		Existing Saturday Midday	
			Delay	LOS	Delay	LOS	Delay	LOS
1	State Route 1 & 14 th Street	TWSC	24.4	C	32.6	D	38.1	E
2	State Route 1 & 16 th Street	TWSC	31.0	D	37.6	E	38.4	E
3	State Route 1 & Carlos Street	TWSC	13.8	B	13.3	B	14.8	B
4	Carlos Street & Sierra Street	TWSC	8.4	A	8.7	A	8.6	A
5	Stetson Street & Sierra Street	TWSC	8.6	A	9.0	A	8.7	A
6	State Route 1 & Vallemar Street / Etheldore Street	TWSC	22.3	C	37.0	E	31.0	D
7	State Route 1 & California Avenue / Wienke Way	TWSC	43.5	E	78.2	F	87.1	F
8	Carlos Street & California Avenue	TWSC	9.8	A	9.4	A	9.9	A
9	Etheldore Street & California Avenue	TWSC	9.5	A	9.7	A	9.7	A
10	Stetson Street & California Avenue	AWSC	7.2	A	7.3	A	7.2	A

Note: Bold lettering indicates an intersection that does not meet the LCP LOS standard (LOS D overall and for critical movements during weekday peak hours, LOS E overall and for critical movements during weekend peak hours).

AWSC: All-Way Stop Control, TWSC: Two-Way Stop Control. LOS and delay reported for TWSC intersections is for the worst approach or movement.

Source: Highway Capacity Manual 2010; Kittelson & Associates, 2022

EXISTING WITH PROJECT CONDITIONS

Existing with Project turning movement volumes are shown in Figure 5 and Figure 6. Table 8, Table 9, and Table 10 show the Existing with Project intersection operations for the weekday AM, weekday PM, and Saturday midday peak hours, respectively. Detailed calculation worksheets for the Existing with Project conditions are provided in APPENDIX 4.

- **Intersection #7 State Route 1 and California Avenue/Wienke Way** operates below the LOS standard in Existing and Existing with Project conditions in the weekday AM, weekday PM, and Saturday midday peak hours. In the weekday PM and Saturday midday peak hours, the addition of project trips adds at least four seconds of average delay for the critical movement.

Table 8: Existing with Project Weekday AM Peak Hour Intersection Operations

No	Location	Control	Existing Weekday AM		Existing + Project Weekday AM	
			Delay	LOS	Delay	LOS
1	State Route 1 & 14th Street	TWSC	24.4	C	25.1	D
2	State Route 1 & 16th Street	TWSC	31.0	D	31.7	D
3	State Route 1 & Carlos Street	TWSC	13.8	B	19.9	C
4	Carlos Street & Sierra Street	TWSC	8.4	A	8.4	A
5	Stetson Street & Sierra Street	TWSC	8.6	A	8.6	A
6	State Route 1 & Vallemar Street / Etheldore Street	TWSC	22.3	C	22.7	C
7	State Route 1 & California Avenue / Wienke Way	TWSC	43.5	E	45.6	E
8	Carlos Street & California Avenue	TWSC	9.8	A	9.8	A
9	Etheldore Street & California Avenue	TWSC	9.5	A	9.5	A
10	Stetson Street & California Avenue	AWSC	7.2	A	7.2	A

Note: **Bold lettering** indicates an intersection that does not meet the LCP LOS standard (LOS D overall and for critical movements during weekday peak hours, LOS E overall and for critical movements during weekend peak hours).

AWSC: All-Way Stop Control, TWSC: Two-Way Stop Control. LOS and delay reported for TWSC intersections is for the worst approach or movement.

Source: Highway Capacity Manual 2010; Kittelson & Associates, 2022

Table 9: Existing with Project Weekday PM Peak Hour Intersection Operations

No	Location	Control	Existing Weekday PM		Existing + Project Weekday PM	
			Delay	LOS	Delay	LOS
1	State Route 1 & 14th Street	TWSC	32.6	D	33.7	D
2	State Route 1 & 16th Street	TWSC	37.6	E	39.1	E
3	State Route 1 & Carlos Street	TWSC	13.3	B	27.5	D
4	Carlos Street & Sierra Street	TWSC	8.7	A	8.7	A
5	Stetson Street & Sierra Street	TWSC	9.0	A	9.0	A
6	State Route 1 & Vallemar Street / Etheldore Street	TWSC	37.0	E	38.2	E
7	State Route 1 & California Avenue / Wienke Way	TWSC	78.2	F	84.1	F
8	Carlos Street & California Avenue	TWSC	9.4	A	9.4	A
9	Etheldore Street & California Avenue	TWSC	9.7	A	9.7	A
10	Stetson Street & California Avenue	AWSC	7.3	A	7.3	A

Note: **Bold lettering** indicates an intersection that does not meet the LCP LOS standard (LOS D overall and for critical movements during weekday peak hours, LOS E overall and for critical movements during weekend peak hours). **Gray highlighted cells** indicate locations where the addition of project trips would either degrade operations to below the LOS standard or add at least four seconds of average delay to the critical movement at a location already operating below the LOS standard.

AWSC: All-Way Stop Control, TWSC: Two-Way Stop Control. LOS and delay reported for TWSC intersections is for the worst approach or movement.

Source: Highway Capacity Manual 2010; Kittelson & Associates, 2022

Table 10: Existing with Project Saturday Midday Peak Hour Intersection Operations

No	Location	Control	Existing Saturday Midday		Existing + Project Saturday Midday	
			Delay	LOS	Delay	LOS
1	State Route 1 & 14th Street	TWSC	38.1	E	39.4	E
2	State Route 1 & 16th Street	TWSC	38.4	E	39.3	E
3	State Route 1 & Carlos Street	TWSC	14.8	B	32.0	D
4	Carlos Street & Sierra Street	TWSC	8.6	A	8.6	A
5	Stetson Street & Sierra Street	TWSC	8.7	A	8.7	A
6	State Route 1 & Vallemar Street / Etheldore Street	TWSC	31.0	D	31.7	D
7	State Route 1 & California Avenue / Wienke Way	TWSC	87.1	F	92.3	F
8	Carlos Street & California Avenue	TWSC	9.9	A	9.9	A
9	Etheldore Street & California Avenue	TWSC	9.7	A	9.7	A
10	Stetson Street & California Avenue	AWSC	7.2	A	7.2	A

Note: **Bold lettering** indicates an intersection that does not meet the LCP LOS standard (LOS D overall and for critical movements during weekday peak hours, LOS E overall and for critical movements during weekend peak hours). **Gray highlighted cells** indicate locations where the addition of project trips would either degrade operations to below the LOS standard or add at least four seconds of average delay to the critical movement at a location already operating below the LOS standard.

AWSC: All-Way Stop Control, TWSC: Two-Way Stop Control. LOS and delay reported for TWSC intersections is for the worst approach or movement.

Source: Highway Capacity Manual 2010; Kittelson & Associates, 2022

H:\20\20616 - Moss Beach Housing TIA\dwg\figs\20616_fig01_revised_for_report.dwg Jan 10, 2018 - 3:05pm - malston Layout Tab: F7 Ex: P

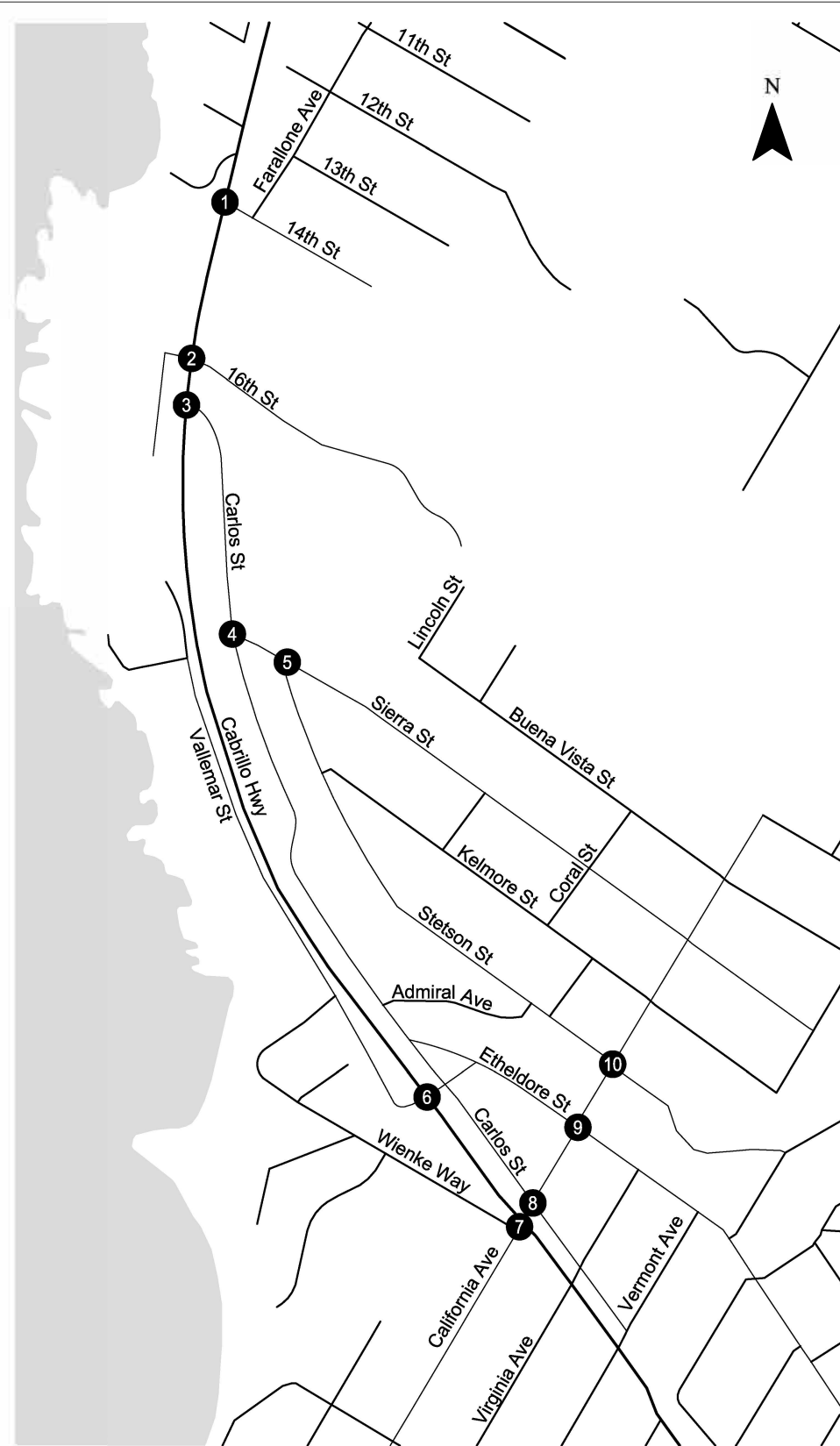

CM = CRITICAL MOVEMENT (UNSIGNALIZED)
 LOS = CRITICAL MOVEMENT LEVEL OF SERVICE (SIGNALIZED)/CRITICAL MOVEMENT LEVEL OF SERVICE (UNSIGNALIZED)
 Del = INTERSECTION AVERAGE CONTROL DELAY (SIGNALIZED)/CRITICAL MOVEMENT CONTROL DELAY (UNSIGNALIZED)
 V/C = CRITICAL CRITICAL VOLUME-TO-CAPACITY RATIO

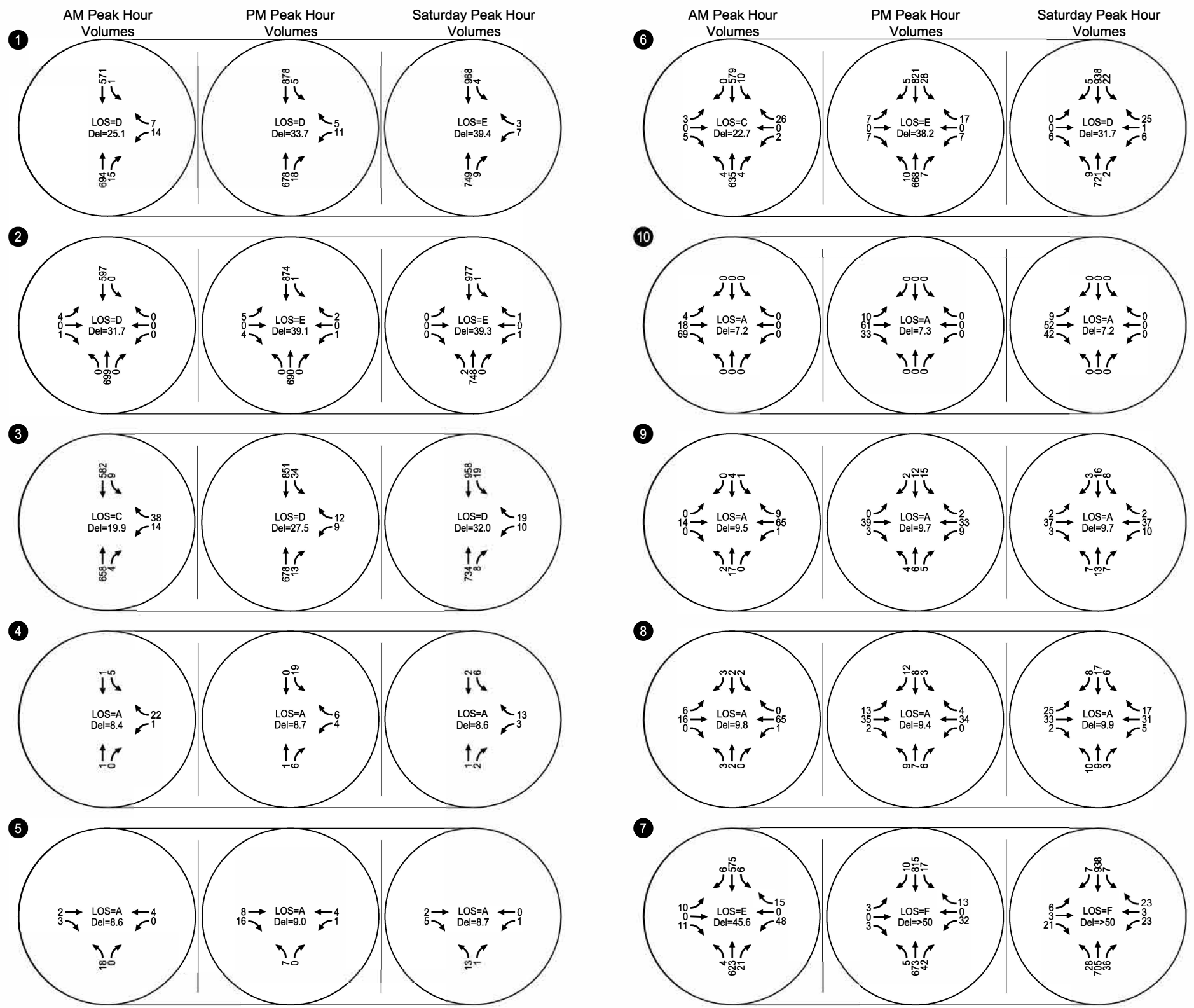

Existing with Project Turning Movement Volumes and Operations
 AM, PM, and Saturday Peak Hour
 Moss Beach, California

Figure 9

FUTURE CONDITIONS

This section describes near-term traffic conditions representing conditions when the project is anticipated to be complete. The Future conditions represent Existing conditions turning movement volumes plus other projects that have been approved or are in the entitlement process but not yet constructed at the time of the traffic counts.

FUTURE NO PROJECT CONDITIONS

The Future conditions turning movement volumes are shown in Figure 10. The Future operations at the study intersections are shown in Table 11. Detailed calculation worksheets for the Future Conditions are provided in APPENDIX 5.

Table 11: Future Conditions Intersection Operations Results

No	Location	Control	Future Weekday AM		Future Weekday PM		Future Saturday Midday	
			Delay	LOS	Delay	LOS	Delay	LOS
1	State Route 1 & 14th Street	TWSC	25.4	D	38.5	E	39.7	E
2	State Route 1 & 16th Street	TWSC	32.3	D	45.2	E	40.3	E
3	State Route 1 & Carlos Street	TWSC	14.0	B	14.1	B	15.0	C
4	Carlos Street & Sierra Street	TWSC	8.4	A	8.7	A	8.6	A
5	Stetson Street & Sierra Street	TWSC	8.6	A	9.0	A	8.7	A
6	State Route 1 & Vallemar Street / Etheldore Street	TWSC	23.2	C	44.3	E	32.3	D
7	State Route 1 & California Avenue / Wienke Way	TWSC	47.4	E	112.6	F	96.1	F
8	Carlos Street & California Avenue	TWSC	9.8	A	9.4	A	9.9	A
9	Etheldore Street & California Avenue	TWSC	9.5	A	9.7	A	9.7	A
10	Stetson Street & California Avenue	AWSC	7.2	A	7.3	A	7.2	A

Note: **Bold lettering** indicates an intersection that does not meet the LCP LOS standard (LOS D overall and for critical movements during weekday peak hours, LOS E overall and for critical movements during weekend peak hours).

AWSC: All-Way Stop Control, TWSC: Two-Way Stop Control. LOS and delay reported for TWSC intersections is for the worst approach or movement.

Source: Highway Capacity Manual 2010; Kittelson & Associates, 2022

FUTURE WITH PROJECT CONDITIONS

Table 12, Table 13, and Table 14 show the Future with Project intersection operations for the weekday AM, weekday PM, and Saturday midday peak hours, respectively. Detailed calculation worksheets for the Future with Project conditions are provided in APPENDIX 6.

- **Intersection #7 State Route 1 and California Avenue/Wienke Way** operates below the LOS standard in Future and Future with Project conditions in the weekday AM, weekday PM, and Saturday midday peak hours. In the weekday PM and Saturday midday peak hour, the addition of project trips adds at least four seconds of average delay for the critical movement.

Table 12: Future with Project Weekday AM Peak Hour Intersection Operations

No	Location	Control	Future Weekday AM		Future with Project Weekday AM	
			Delay	LOS	Delay	LOS
1	State Route 1 & 14th Street	TWSC	25.4	D	26.1	D
2	State Route 1 & 16th Street	TWSC	32.3	D	33.2	D
3	State Route 1 & Carlos Street	TWSC	14	B	20.7	C
4	Carlos Street & Sierra Street	TWSC	8.4	A	8.4	A
5	Stetson Street & Sierra Street	TWSC	8.6	A	8.6	A
6	State Route 1 & Vallemar Street / Etheldore Street	TWSC	23.2	C	23.6	C
7	State Route 1 & California Avenue / Wienke Way	TWSC	47.4	E	49.9	E
8	Carlos Street & California Avenue	TWSC	9.8	A	9.8	A
9	Etheldore Street & California Avenue	TWSC	9.5	A	9.5	A
10	Stetson Street & California Avenue	AWSC	7.2	A	7.2	A

Note: **Bold lettering** indicates an intersection that does not meet the LCP LOS standard (LOS D overall and for critical movements during weekday peak hours, LOS E overall and for critical movements during weekend peak hours). **Gray highlighted cells** indicate locations where the addition of project trips would either degrade operations to below the LOS standard or add at least four seconds of average delay to the critical movement at a location already operating below the LOS standard.

Source: Highway Capacity Manual 2010; Kittelson & Associates, 2022

Table 13: Future with Project Weekday PM Peak Hour Intersection Operations

No	Location	Control	Future Weekday PM		Future with Project Weekday PM	
			Delay	LOS	Delay	LOS
1	State Route 1 & 14th Street	TWSC	38.5	E	39.8	E
2	State Route 1 & 16th Street	TWSC	45.2	E	47.6	E
3	State Route 1 & Carlos Street	TWSC	14.1	B	32.2	D
4	Carlos Street & Sierra Street	TWSC	8.7	A	8.7	A
5	Stetson Street & Sierra Street	TWSC	9.0	A	9.0	A
6	State Route 1 & Vallemar Street / Etheldore Street	TWSC	44.3	E	46.1	E
7	State Route 1 & California Avenue / Wienke Way	TWSC	112.6	F	124.2	F
8	Carlos Street & California Avenue	TWSC	9.4	A	9.4	A
9	Etheldore Street & California Avenue	TWSC	9.7	A	9.7	A
10	Stetson Street & California Avenue	AWSC	7.3	A	7.3	A

Note: **Bold lettering** indicates an intersection that does not meet the LCP LOS standard (LOS D overall and for critical movements during weekday peak hours, LOS E overall and for critical movements during weekend peak hours). **Gray highlighted cells** indicate locations where the addition of project trips would either degrade operations to below the LOS standard or add at least four seconds of average delay to the critical movement at a location already operating below the LOS standard.

Source: Highway Capacity Manual 2010; Kittelson & Associates, 2022

Table 14: Future with Project Saturday Midday Peak Hour Intersection Operations

No	Location	Control	Future Saturday Midday		Future with Project Saturday Midday	
			Delay	LOS	Delay	LOS
1	State Route 1 & 14th Street	TWSC	39.7	E	41.1	E
2	State Route 1 & 16th Street	TWSC	40.3	E	41.0	E
3	State Route 1 & Carlos Street	TWSC	15.0	C	45.7	E
4	Carlos Street & Sierra Street	TWSC	8.6	A	8.6	A
5	Stetson Street & Sierra Street	TWSC	8.7	A	8.7	A
6	State Route 1 & Vallemar Street / Etheldore Street	TWSC	32.3	D	33.4	D
7	State Route 1 & California Avenue / Wienke Way	TWSC	96.1	F	102.4	F
8	Carlos Street & California Avenue	TWSC	9.9	A	9.9	A
9	Etheldore Street & California Avenue	TWSC	9.7	A	9.7	A
10	Stetson Street & California Avenue	AWSC	7.2	A	7.2	A

Note: **Bold lettering** indicates an intersection that does not meet the LCP LOS standard (LOS D overall and for critical movements during weekday peak hours, LOS E overall and for critical movements during weekend peak hours). **Gray highlighted cells** indicate locations where the addition of project trips would either degrade operations to below the LOS standard or add at least four seconds of average delay to the critical movement at a location already operating below the LOS standard.

Source: Highway Capacity Manual 2010; Kittelson & Associates, 2022

\\kittelson.com\sa\h_projects\20\20616 - Moss Beach Housing TIA\2021-22 CDP app support\Report\Updated Figs\20616_Figures.dwg Jun 28, 2022 - 6:10pm - kdao Layout Tab: F10 Future +P

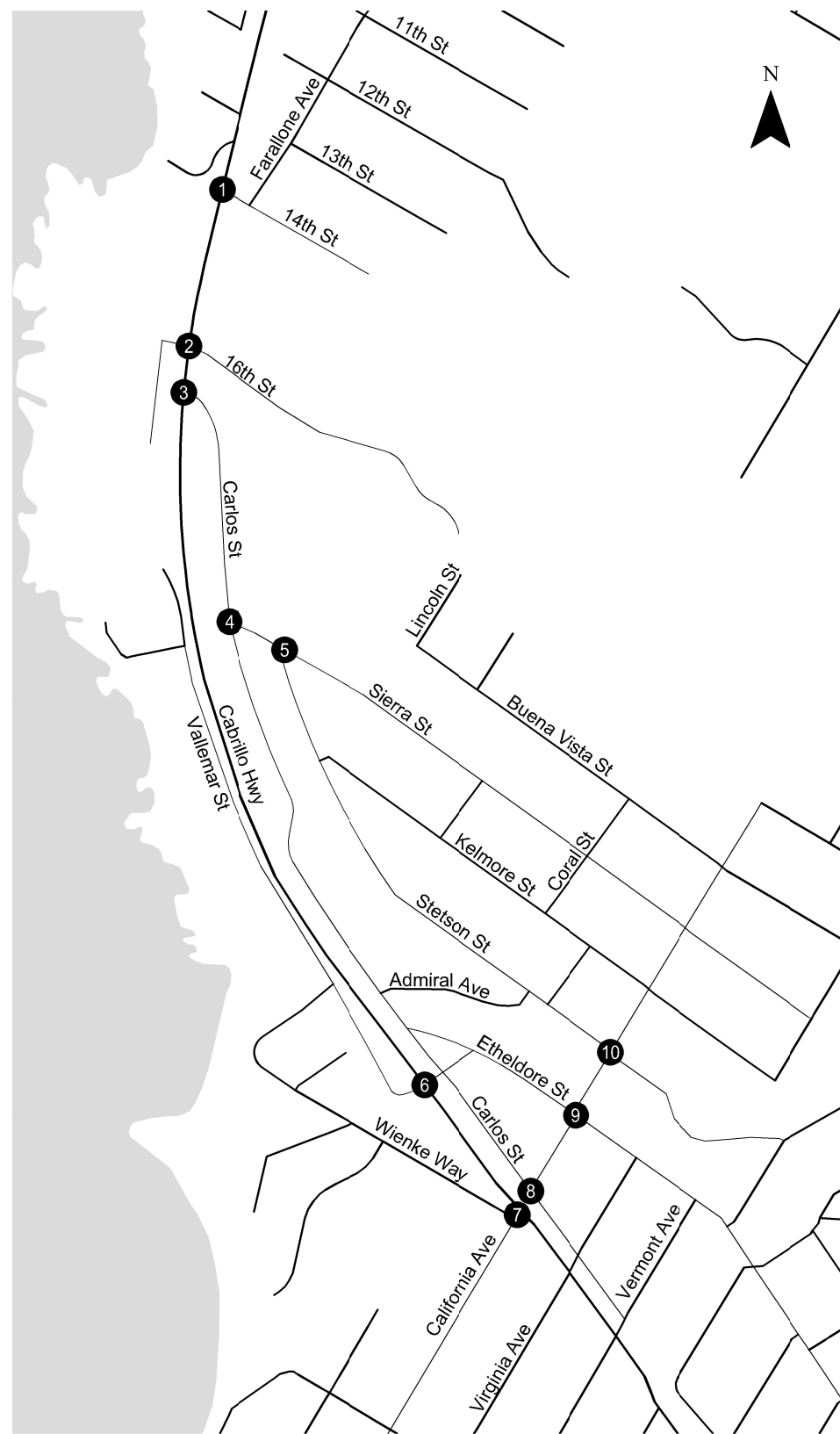

CM = CRITICAL MOVEMENT (UNSIGNALIZED)
 LOS = CRITICAL MOVEMENT LEVEL OF SERVICE (SIGNALIZED)/CRITICAL MOVEMENT LEVEL OF SERVICE (UNSIGNALIZED)
 Del = INTERSECTION AVERAGE CONTROL DELAY (SIGNALIZED)/CRITICAL MOVEMENT CONTROL DELAY (UNSIGNALIZED)
 V/C = CRITICAL CRITICAL VOLUME-TO-CAPACITY RATIO

● - STOP SIGN
 - TRAFFIC SIGNAL

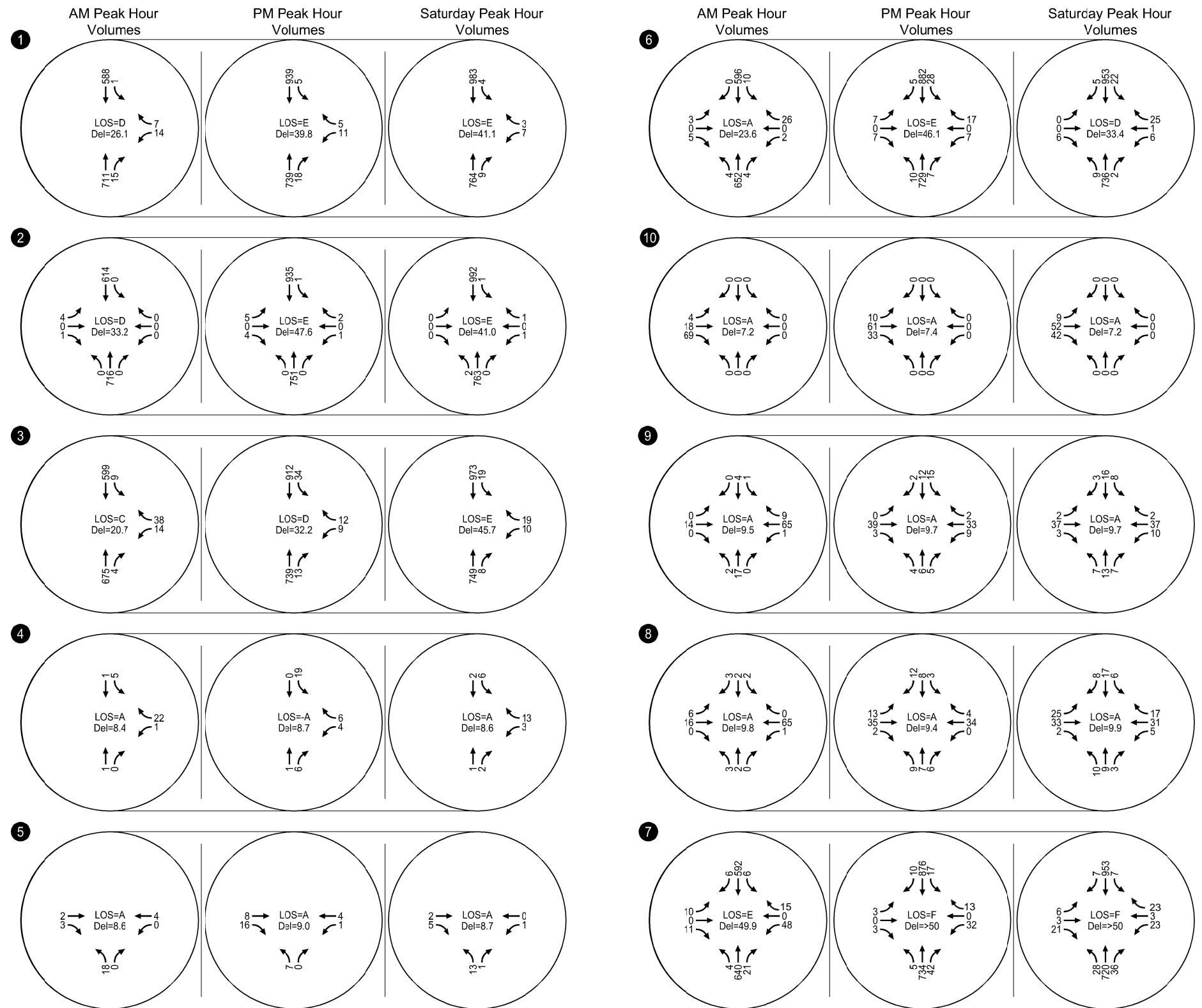

Future with Project Turning Movement Volumes and Operations
 AM, PM, and Saturday Peak Hour
 Moss Beach, California

Figure 10

CUMULATIVE CONDITIONS

This section presents the anticipated Cumulative conditions for the study intersections for the year 2040 and the effect the addition of the project trips would have on them.

CUMULATIVE NO PROJECT CONDITIONS

The Cumulative conditions turning movement volumes are shown in Figure 12. The Cumulative operations at the study intersections are shown in Table 15. Detailed calculation worksheets for the Future Conditions are provided in APPENDIX 7.

Table 15: Cumulative Conditions Intersection Operations Results

No	Location	Control	Cumulative Weekday AM		Cumulative Weekday PM		Cumulative Saturday Midday	
			Delay	LOS	Delay	LOS	Delay	LOS
1	State Route 1 & 14th Street	TWSC	58.2	F	>80	F	59.8	F
2	State Route 1 & 16th Street	TWSC	74.7	F	>80	F	59.7	F
3	State Route 1 & Carlos Street	TWSC	16.2	C	18.8	C	19.5	C
4	Carlos Street & Sierra Street	TWSC	8.5	A	8.8	A	8.6	A
5	Stetson Street & Sierra Street	TWSC	8.7	A	9.1	A	8.8	A
6	State Route 1 & Vallemar Street / Etheldore Street	TWSC	52.3	F	>80	F	34.1	D
7	State Route 1 & California Avenue / Wienke Way	TWSC	>80	F	>80	F	>80	F
8	Carlos Street & California Avenue	TWSC	10.0	B	9.7	A	10.2	B
9	Etheldore Street & California Avenue	TWSC	9.7	A	9.9	A	10.0	B
10	Stetson Street & California Avenue	AWSC	7.3	A	7.4	A	7.2	A



Note: **Bold lettering** indicates an intersection that does not meet the LCP LOS standard (LOS D overall and for critical movements during weekday peak hours, LOS E overall and for critical movements during weekend peak hours).

AWSC: All-Way Stop Control, TWSC: Two-Way Stop Control. LOS and delay reported for TWSC intersections is for the worst approach or movement.

Source: Highway Capacity Manual 2010; Kittelson & Associates, 2022

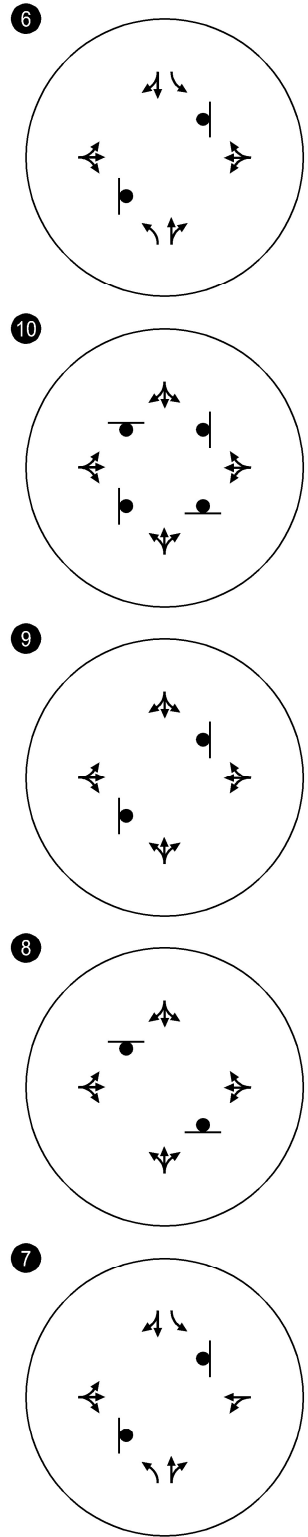
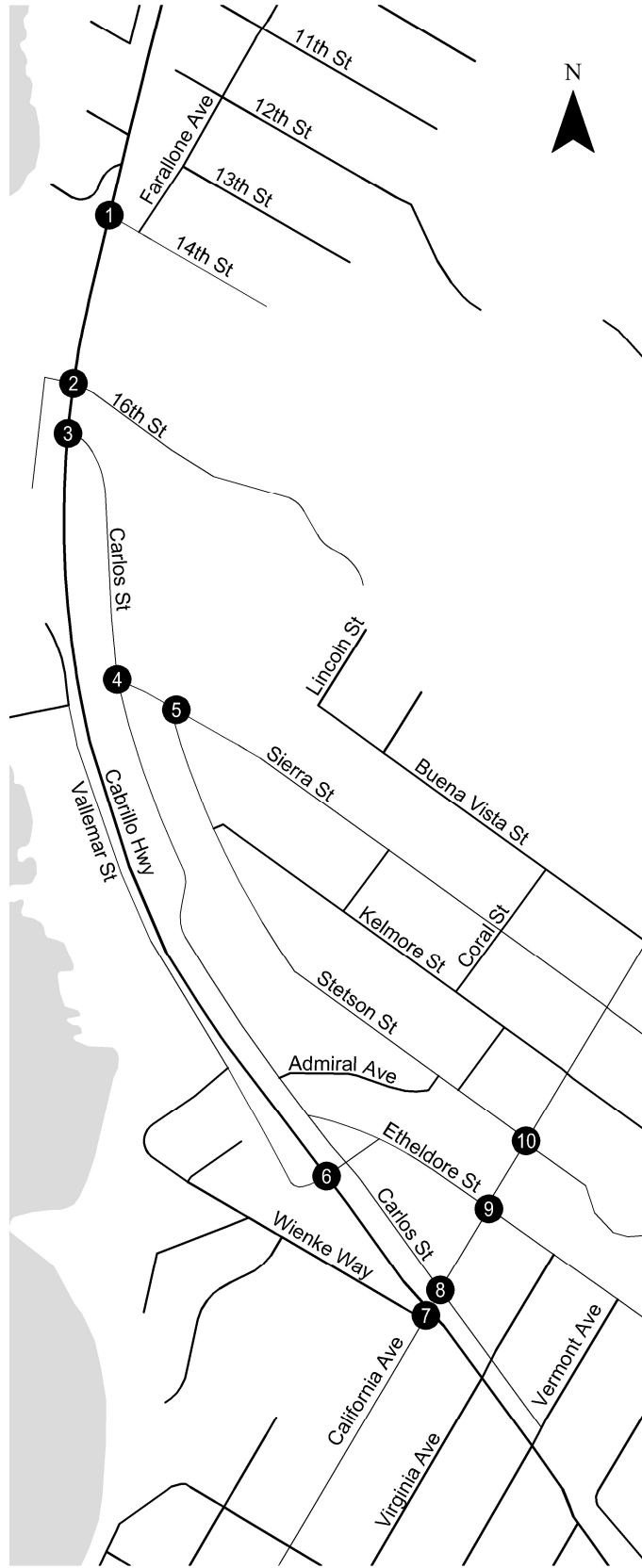
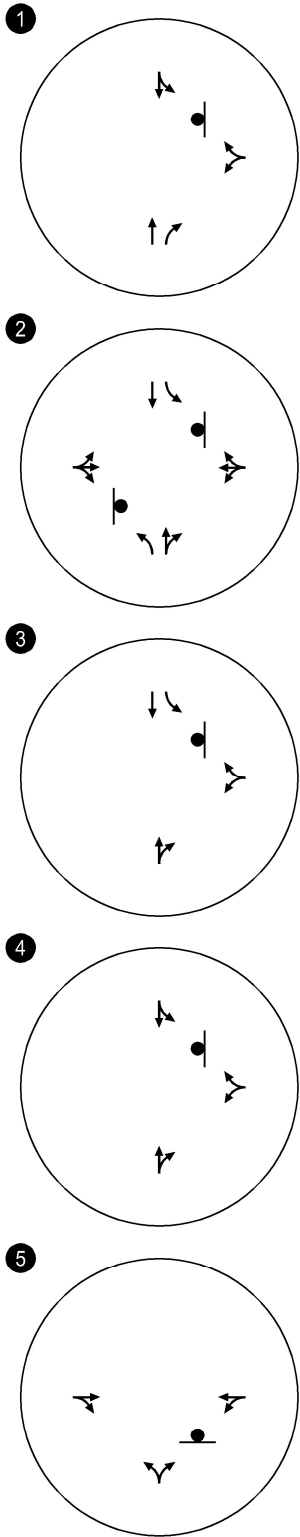
\\kittelton.com\sa\h_project\20\20616 - Moss Beach Housing TIA\2021-22 CDP app support\Report\update\figs\20616_Figures.dwg Jun 28, 2022 - 6:05pm - k daio Layout Tab: F11 CUUM TCDs (revised)



-  - STOP SIGN
-  - TRAFFIC SIGNAL

Cumulative Lane Configurations and Traffic Control Devices Moss Beach, California

Figure 11

CUMULATIVE WITH PROJECT CONDITIONS

This section discusses the effect of the project on traffic operations under Cumulative conditions. Traffic volumes for the Cumulative with Project condition were developed using the same additive approach used for the Existing with Project and Future with Project volumes. The turning movement volumes resulting from adding the project trips to the Cumulative conditions volumes are shown in Figure 12.

Table 16, Table 17, and Table 18 show the Cumulative with Project intersection operations for the weekday AM, weekday PM, and Saturday midday peak hours, respectively. Detailed calculation worksheets for the Cumulative with Project conditions are provided in APPENDIX 8. Based on the criteria previously described the project increase delay beyond the identified thresholds at the following locations:

- **Intersection #2: State Route 1 and 16th Street** operates below the LOS standard in Cumulative no Project conditions in the weekday AM, weekday PM, and Saturday midday peak hours. The addition of project trips increases delay for the critical movement at the intersection already exceeding the LOS standard by at least 4 seconds per vehicle during the weekday PM peak hour.
- **Intersection #3: State Route 1 and Carlos Street** operates within the LOS standards in Cumulative no Project conditions. The addition of project trips causes the intersection to degrade below the LOS standard during the weekday AM and weekday PM peak hour.¹⁶
- **Intersection #6: State Route 1 and Vallemar Street/Etheldore Street** operates below the LOS standard in Cumulative no Project conditions in the weekday AM and weekday PM peak hours. The addition of project trips increases delay for the critical movement at the intersection already exceeding the LOS standard by at least 4 seconds per vehicle during the weekday PM peak hour.
- **Intersection #7: State Route 1 and California Avenue/Wienke Way** operated below the LOS standard in Cumulative no Project conditions in the weekday AM, weekday PM, and Saturday midday peak hours. The addition of project trips increases delay for the critical movement at the intersection already exceeding the LOS standard by at least 4 seconds in the weekday AM, weekday PM, and Saturday midday peak hours.

¹⁶ The County is currently studying a project that would remove this intersection and provide an alternative intersection geometry, configuration and traffic control. For more information, see the Impact T-1 discussion in the Sight Distance and Safety Impacts section beginning on page 37.

Table 16: Cumulative with Project Weekday AM Peak Hour Intersection Operations

No	Location	Control	Cumulative Weekday AM		Cumulative Weekday AM + Project	
			Delay	LOS	Delay	LOS
1	State Route 1 & 14th Street	TWSC	58.2	F	60.6	F
2	State Route 1 & 16th Street	TWSC	74.7	F	77.5	F
3	State Route 1 & Carlos Street	TWSC	16.2	C	36.7	E
4	Carlos Street & Sierra Street	TWSC	8.5	A	8.5	A
5	Stetson Street & Sierra Street	TWSC	8.7	A	8.7	A
6	State Route 1 & Vallemar Street / Etheldore Street	TWSC	>80	F	>80	F
7	State Route 1 & California Avenue / Wienke Way	TWSC	>80	F	>80	F
8	Carlos Street & California Avenue	TWSC	10.0	B	10.0	B
9	Etheldore Street & California Avenue	TWSC	9.7	A	9.7	A
10	Stetson Street & California Avenue	AWSC	7.3	A	7.3	A

Note: **Bold lettering** indicates an intersection that does not meet the LCP LOS standard (LOS D overall and for critical movements during weekday peak hours, LOS E overall and for critical movements during weekend peak hours). **Gray highlighted cells** indicate locations where the addition of project trips would either degrade operations to below the LOS standard or add at least four seconds of average delay to the critical movement at a location already operating below the LOS standard.

Source: Highway Capacity Manual 2010; Kittelson & Associates, 2022

Table 17: Cumulative with Project Weekday PM Peak Hour Intersection Operations

No	Location	Control	Cumulative Weekday PM		Cumulative Weekday PM + Project	
			Delay	LOS	Delay	LOS
1	State Route 1 & 14th Street	TWSC	88.6	F	92.5	F
2	State Route 1 & 16th Street	TWSC	105.3	F	114.2	F
3	State Route 1 & Carlos Street	TWSC	18.8	C	64.2	F
4	Carlos Street & Sierra Street	TWSC	8.8	A	8.8	A
5	Stetson Street & Sierra Street	TWSC	9.1	A	9.1	A
6	State Route 1 & Vallemar Street / Etheldore Street	TWSC	106.3	F	112.0	F
7	State Route 1 & California Avenue / Wienke Way	TWSC	>80	F	>80	F
8	Carlos Street & California Avenue	TWSC	9.7	A	9.7	A
9	Etheldore Street & California Avenue	TWSC	9.9	A	9.9	A
10	Stetson Street & California Avenue	AWSC	7.4	A	7.4	A

Note: **Bold lettering** indicates an intersection that does not meet the LCP LOS standard (LOS D overall and for critical movements during weekday peak hours, LOS E overall and for critical movements during weekend peak hours). **Gray highlighted cells** indicate locations where the addition of project trips would either degrade operations to below the LOS standard or add at least four seconds of average delay to the critical movement at a location already operating below the LOS standard.

AWSC: All-Way Stop Control, TWSC: Two-Way Stop Control. LOS and delay reported for TWSC intersections is for the worst approach or movement.

Source: Highway Capacity Manual 2010; Kittelson & Associates, 2022

Table 18: Cumulative with Project Saturday Midday Peak Hour Intersection Operations

No	Location	Control	Cumulative Saturday Midday		Cumulative Saturday Midday + Project	
			Delay	LOS	Delay	LOS
1	State Route 1 & 14th Street	TWSC	59.8	F	60.6	F
2	State Route 1 & 16th Street	TWSC	59.7	F	61.4	F
3	State Route 1 & Carlos Street	TWSC	19.5	C	49.1	E
4	Carlos Street & Sierra Street	TWSC	8.6	A	8.6	A
5	Stetson Street & Sierra Street	TWSC	8.8	A	8.8	A
6	State Route 1 & Vallemar Street / Etheldore Street	TWSC	34.1	D	35.1	E
7	State Route 1 & California Avenue / Wienke Way	Signal	>80	F	>80	F
8	Carlos Street & California Avenue	TWSC	10.2	B	10.2	B
9	Etheldore Street & California Avenue	TWSC	10.0	B	10.0	B
10	Stetson Street & California Avenue	AWSC	7.2	A	7.2	A

Note: **Bold lettering** indicates an intersection that does not meet the LCP LOS standard (LOS D overall and for critical movements during weekday peak hours, LOS E overall and for critical movements during weekend peak hours). **Gray highlighted cells** indicate locations where the addition of project trips would either degrade operations to below the LOS standard or add at least four seconds of average delay to the critical movement at a location already operating below the LOS standard.

Source: Highway Capacity Manual 2010; Kittelson & Associates, 2022

\\kittelson.com\Projects\20\20616 - Moss Beach Housing TIA\2021-22 CDP app support\Report\Updated Figs\20616_Figures.dwg Jun 28, 2022 - 7:12pm - kdar Layout Tab: F13 CUM w PRJ

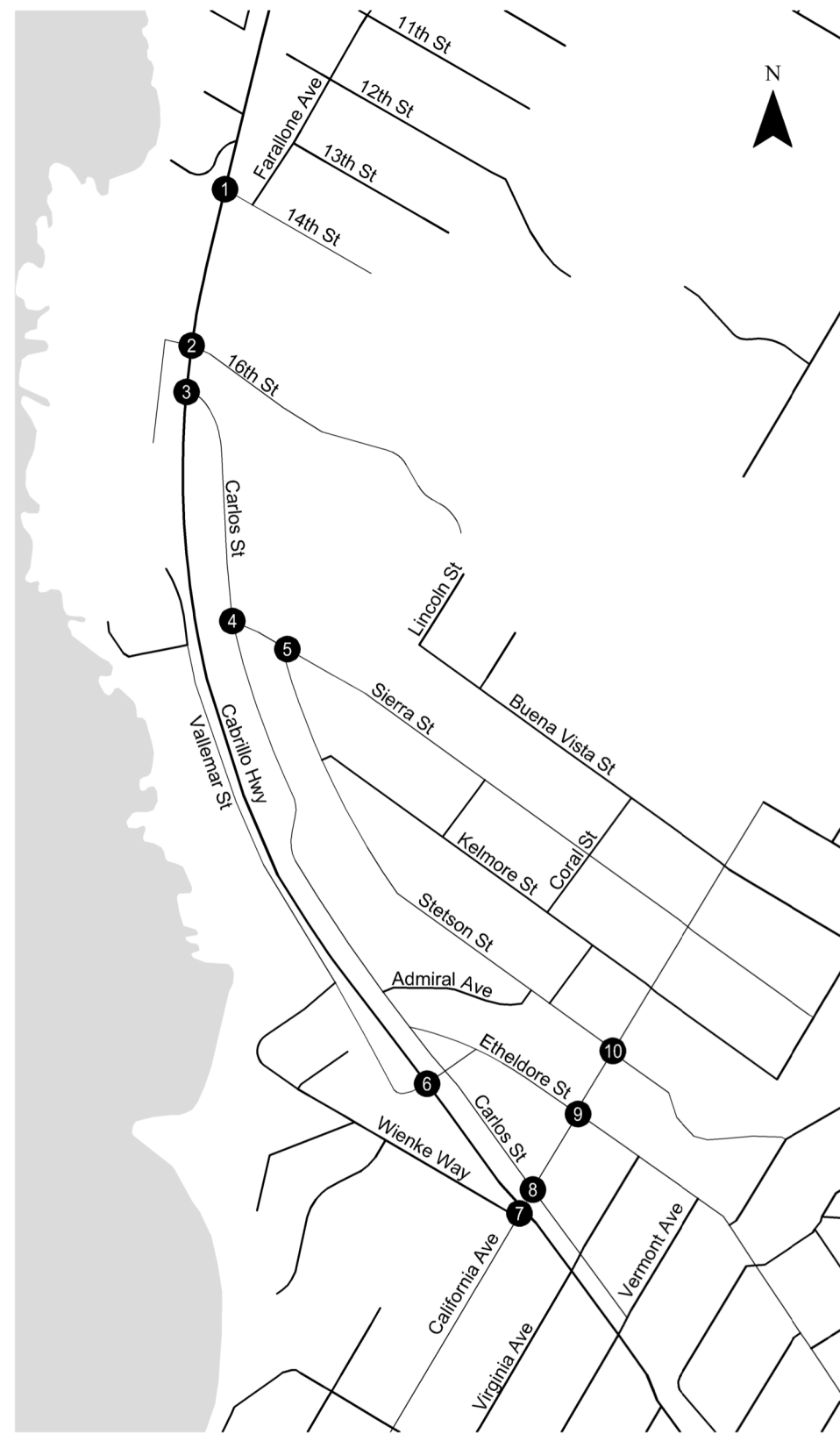

CM = CRITICAL MOVEMENT (UNSIGNALIZED)
 LOS = CRITICAL MOVEMENT LEVEL OF SERVICE (SIGNALIZED)/CRITICAL MOVEMENT LEVEL OF SERVICE (UNSIGNALIZED)
 Del = INTERSECTION AVERAGE CONTROL DELAY (SIGNALIZED)/CRITICAL MOVEMENT CONTROL DELAY (UNSIGNALIZED)
 V/C = CRITICAL CRITICAL VOLUME-TO-CAPACITY RATIO

● - STOP SIGN
 - TRAFFIC SIGNAL

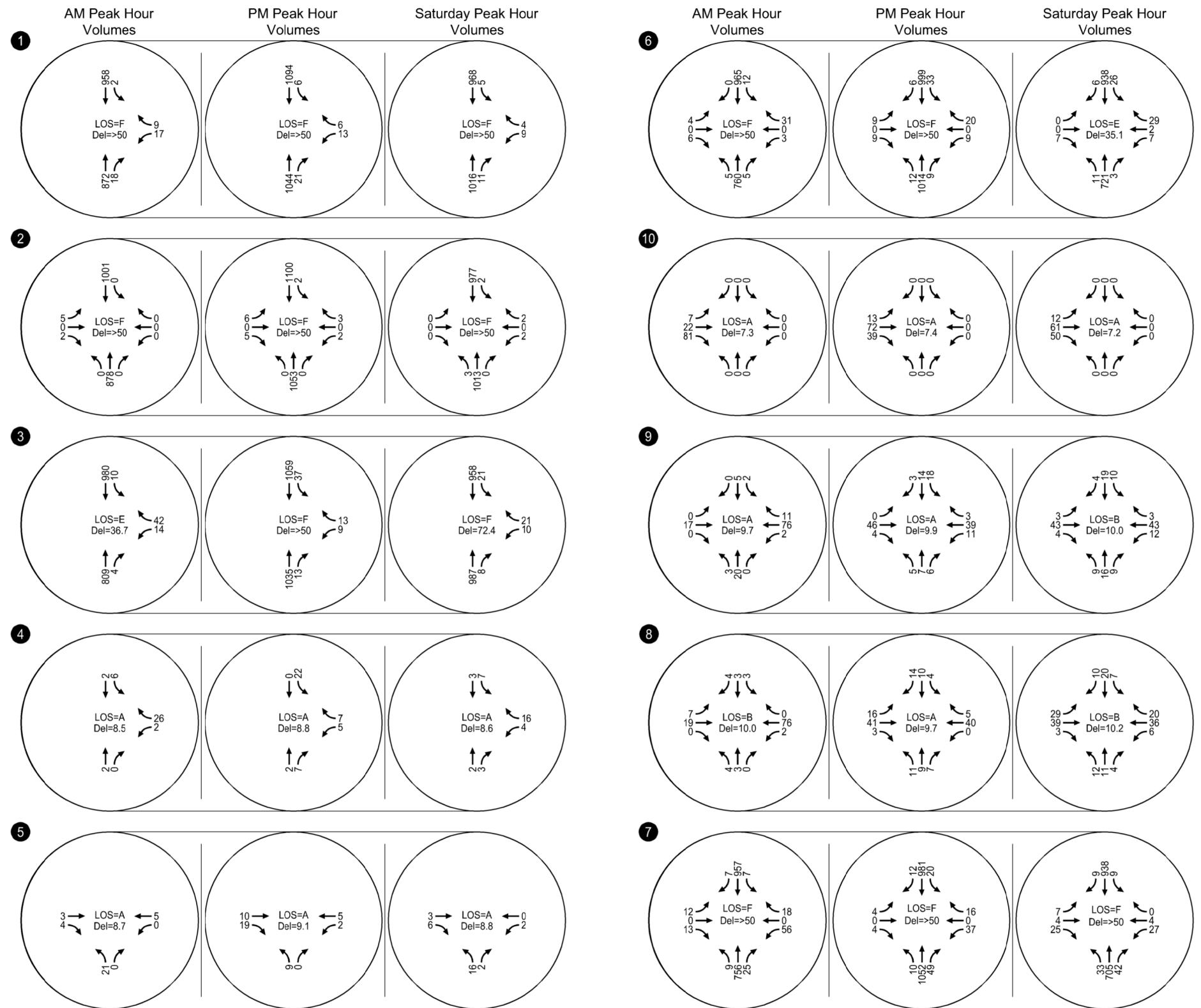

Cumulative with Project Turning Movement Volumes and Operations
 AM, PM, and Saturday Peak Hour
 Moss Beach, California

Figure
 12

THRESHOLD COMPARISON

As explained in the Definition of Acceptable Operations section on page 13, this report references LOS standards from LCP Policy 2.44. Those standards consider LOS D acceptable in the weekday AM or PM peak hour and LOS E acceptable in the weekend midday peak hour.

San Mateo County provides different LOS thresholds in a 2014 *Traffic Impact Study Requirements* document¹⁷, which considers the minimum acceptable LOS to be LOS C overall, with, “no individual movement operating at less than ‘D’,” though it notes that “On occasion, level of service ‘D’ may be allowed for peak periods in dense urban conditions per County’s discretion.”

Upon review, the County indicated that the LCP Policy 2.44 was the appropriate and applicable threshold for this analysis, given that the TIS Requirements are not adopted as official policy and are not mandatory.

Applying this stricter threshold would have changed the effects identified for some identified intersections at certain times of day/analysis scenarios. The additionally identified scenarios include:

- **Existing plus project conditions:** no change in results
- **Future plus project conditions:** one additional effect identified (intersection #3 in Saturday midday peak hour conditions)
- **Cumulative plus project conditions:** two additional effects identified -- intersection #3 and #6 in Saturday midday peak hour conditions

The recommended operations improvements (identified in the next section) would not change.

RECOMMENDED OPERATIONS IMPROVEMENTS

This section includes recommendations that relate to the local circulation and operations effects of the proposed project.

Intersection 7: The additional traffic generated by project-related trips would result in an increase in delay for the critical movement at the intersection of State Route 1 and California Avenue/Wienke Way (#7).

This effect was identified in the following analysis scenarios:

- **Existing with project:** The addition of project trips causes the delay for the critical movement to increase by more than 4 seconds during the weekday PM and Saturday midday peak hours for an intersection already operating below the LCP LOS standard.
- **Future with project conditions:** The addition of project trips causes the delay for the critical movement to increase by more than 4 seconds during the weekday PM and Saturday midday peak hours for an intersection already operating below the LCP LOS standard.
- **Cumulative with project conditions:** The addition of project trips increases delay for the critical movement at the intersection already exceeding the LOS standard by at least 4 seconds in the weekday AM, weekday PM, and Saturday midday peak hours.

Improvement Measure T-1: Provide Additional TDM Measures, proposed and described as Mitigation Measure T-1 in the Conclusions and Mitigation Measures section beginning on page 37, would be expected to reduce project trips. Although a TDM plan would reduce the vehicle trip generation and reduce the effect, the effectiveness of a TDM plan cannot be guaranteed. Implementation of Mitigation

¹⁷ County of San Mateo. *Traffic Impact Study Requirements*. December 9, 2014

Measure T-1 would reduce project-related vehicle trips but would not completely offset project-related trips and would not guarantee a reduction of these operations-related effects.

Improvement Measure T-1: Convert State Route 1 & California Avenue/Wienke Way to a Traffic Signal or Roundabout.

San Mateo County would work with Caltrans to convert the intersection control from two-way stop control into a roundabout or signalized intersection. The exact intersection control will be determined at the conclusion of an Intersection Control Evaluation (ICE) study as required by Caltrans. The ICE study would be performed as part of the design phase for changing the intersection control.

The intersection was modeled as a five-leg signalized intersection and as a single-lane roundabout to assess the mitigation measure. Conversion to either form of traffic control would improve the operation of this intersection to LOS A or LOS B, within identified LOS standards, during all analyzed time periods and scenarios.

In October 2021, the County published the final draft of its *Connect the Coastside* report, which serves as the San Mateo County Midcoast Comprehensive Transportation Management Plan. The report includes a suite of project, policy, and program recommendations to address current and future transportation needs.

The study recommends a change of traffic control at this intersection (with a preliminary recommendation of a multilane roundabout), and the project is listed as "near-term" a project (0 to 7 years). A more detailed analysis would be performed as part of an intersection control evaluation (ICE) during the design phase to select whether a roundabout or signal is preferred. The project is not funded.

Although this mitigation measure with conversion to a signalized intersection would lessen this effect, this intersection is under the jurisdiction of Caltrans. Thus, San Mateo County would need to obtain an encroachment permit from Caltrans. Implementation authority does not rest exclusively with the County.

Intersection 1: The additional traffic generated by project-related trips would result in an increase in delay for the critical movement at the intersection of State Route 1 and 16th Street (#1).

The addition of project trips causes the delay for the critical movement to increase by more than 4 seconds during the weekday PM peak hour in the Cumulative with project scenario for an intersection already operating below the identified LOS standard.

Improvement Measure T-1: Provide Additional TDM Measures, proposed and described as Mitigation Measure T-1 in the Conclusions and Mitigation Measures section beginning on page 37, would be expected to reduce project trips. Although a TDM plan would reduce the vehicle trip generation and reduce the effect, the effectiveness of a TDM plan cannot be guaranteed. Implementation of Mitigation Measure T-1 would reduce project-related vehicle trips but would not completely offset project-related trips and would not guarantee a reduction of these operations-related effects. Additional improvement measures were considered including signalization, left turn restrictions, and the addition of left turn lanes. However, these options were determined to not be feasible for the following reasons:

- **Signalization.** The intersection of 16th Street and State Route 1 does not meet the peak hour signal warrant (APPENDIX 10); therefore, signalization is not warranted.
- **Left Turn Restrictions.** Restricting the westbound left turn out of 16th Street and State Route 1 during the peak periods and reassigning them to the right turn movement would reduce the delay to below the threshold. However, Caltrans has indicated that they would not allow this type of restriction, making this option infeasible.
- **Additional Turn Lanes.** Adding exclusive left turn lane on westbound approach at the intersection would separate the left and right turning traffic reducing queues and delay. However, separating the left and through/right lanes was not sufficient to eliminate the effect since the left turn lanes still have a delay that is at least 4 seconds higher than the no Project conditions.

Intersection 3: The additional traffic generated by project-related trips would result in an increase in delay for the critical movement at the intersection of State Route 1 and Carlos Street (#3).

This additional delay was identified in the Cumulative with project weekday AM and weekday PM peak hours. This intersection would serve as the main access point to the project from State Route 1. To reduce this additional delay, improvement measures would be the same as the mitigation measures recommended for Impact T-1 beginning on page 37 (Mitigation Measure T-1 and Mitigation Measure T-2).

The closure proposed in Mitigation Measure T-2 would make a discussion of operations at the subject intersection irrelevant since existing and Project traffic would instead be routed south along Carlos Street and Stetson Street to access State Route 1 at either Etheldore Street or California Avenue.

However, traffic redistribution associated with this closure was modeled and found to result in a secondary significant impact at the intersection of Etheldore Street and State Route 1 where the critical movement delay fell below the relevant LOS threshold in the Existing with Project weekday PM scenario, Near-Term with Project weekday AM and Saturday midday scenarios, and the Cumulative with Project Saturday midday scenario. Table 16 shows the scenarios for which additional effects would occur. Improvement measures for Intersection 6 are discussed in the next section.

Table 19: Cumulative with Project Weekday AM Peak Hour Intersection Operations

No	Location	Control	No Project		With Project		With Project and Rerouted Traffic	
			Delay	LOS	Delay	LOS	Delay	LOS
1	Existing Weekday PM	TWSC	37.0	E	38.2	E	41.5	E
3	Near-Term Weekday PM	TWSC	44.3	E	46.1	E	50.8	F
4	Near-Term Saturday Midday	TWSC	32.3	D	33.4	D	54.6	F
5	Cumulative Saturday Midday	TWSC	34.1	D	35.1	E	58	F

Note: **Bold lettering** indicates an intersection that does not meet the LCP LOS standard (LOS D overall and for critical movements during weekday peak hours, LOS E overall and for critical movements during weekend peak hours). **Gray highlighted cells** indicate locations where the addition of project trips would either degrade operations to below the LOS standard or add at least four seconds of average delay to the critical movement at a location already operating below the LOS standard.

Source: Highway Capacity Manual 2010; Kittelson & Associates, 2022

Intersection 6: The additional traffic generated by project-related trips would result in an increase in delay for the critical movement at the intersection of State Route 1 and Vallemar/Etheldore Street (#6).

This increase was identified in the Cumulative with project weekday AM and PM peak hours. This intersection would serve as the main access point to the project from State Route 1. To reduce this additional delay, the following improvement measures are proposed.

Improvement Measure T-1: Provide Additional TDM Measures, proposed and described as Mitigation Measure T-1 in the Conclusions and Mitigation Measures section beginning on page 37, would be expected to reduce project trips. Although a TDM plan would reduce the vehicle trip generation and reduce the effect, the effectiveness of a TDM plan cannot be guaranteed. Implementation of Mitigation Measure T-1 would reduce project-related vehicle trips but would not completely offset project-related trips and would not guarantee a reduction of these operations-related effects.

Additional improvement measures were considered including signalization, left turn restrictions, and the addition of left turn lanes. However, these options were determined to not be feasible for the following reasons:

- **Signalization.** The intersection of Etheldore Street and State Route 1 does not meet the peak hour signal warrant (APPENDIX 10), therefore, signalization is not warranted.

- **Left Turn Restrictions.** Restricting the eastbound and westbound left turns out of Etheldore Street and State Route 1 during the peak periods and reassigning them to the intersection of California Avenue/Wienke Way and State Route 1 would reduce the delay to below the identified threshold. However, Caltrans has indicated that they would not allow this type of restriction, making this option infeasible.
- **Additional Turn Lanes.** Adding exclusive left turn lanes on the eastbound and westbound approaches at the intersection would separate the left and right turning traffic reducing queues and delay. However, separating the left and through/right lanes was not sufficient to reduce the delay since the left turn lanes still have a delay that is at least 4 seconds higher than in the No project conditions.

APPENDIX

APPENDIX 1.

TURNING MOVEMENT COUNTS

LOCATION: Cabrillo Hwy (Hwy 1) -- 14th St
CITY/STATE: Montara, CA

QC JOB #: 14384607
DATE: Thu, Apr 20 2017

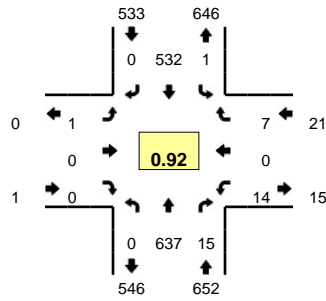

Peak-Hour: 7:45 AM -- 8:45 AM
Peak 15-Min: 8:10 AM -- 8:25 AM

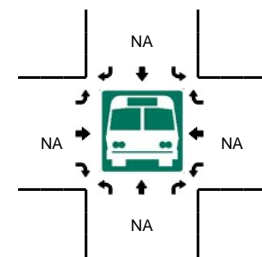
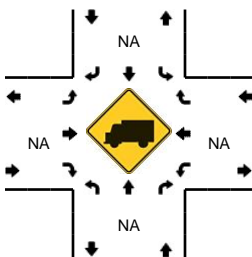
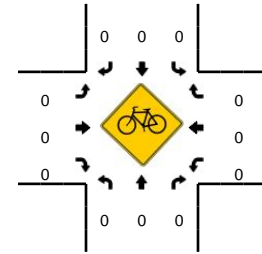
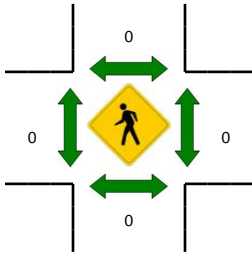
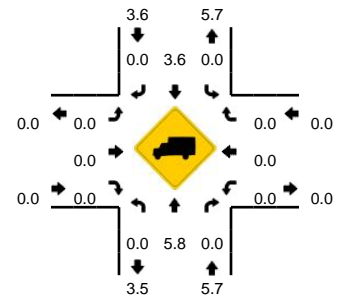

5-Min Count Period Beginning At	Cabrillo Hwy (Hwy 1) (Northbound)				Cabrillo Hwy (Hwy 1) (Southbound)				14th St (Eastbound)				14th St (Westbound)				Total	Hourly Totals	
	Left	Thru	Right	U	Left	Thru	Right	U	Left	Thru	Right	U	Left	Thru	Right	U			
7:00 AM	0	59	0	0	0	23	0	0	0	0	0	0	0	0	0	1	0	83	
7:05 AM	0	50	0	0	0	22	0	0	0	0	0	0	0	1	0	0	0	73	
7:10 AM	0	49	0	0	0	33	0	0	0	0	0	0	0	2	0	4	0	88	
7:15 AM	0	57	0	0	0	24	0	0	0	0	0	0	0	0	0	0	0	81	
7:20 AM	0	62	0	0	0	26	0	0	0	0	0	0	0	2	0	1	0	91	
7:25 AM	0	47	0	0	0	30	0	0	0	0	0	0	0	1	0	0	0	78	
7:30 AM	0	55	0	0	0	21	0	0	0	0	0	0	0	2	0	1	0	79	
7:35 AM	0	51	0	0	0	37	0	0	0	0	0	0	0	4	0	0	0	92	
7:40 AM	0	60	0	0	0	38	0	0	0	0	0	0	0	0	0	2	0	100	
7:45 AM	0	55	0	0	0	46	0	0	0	0	0	0	0	0	0	0	0	101	
7:50 AM	0	59	1	0	0	52	0	0	1	0	0	0	0	3	0	0	0	116	
7:55 AM	0	48	0	0	0	34	0	0	0	0	0	0	0	2	0	2	0	86	1068
8:00 AM	0	50	1	0	0	22	0	0	0	0	0	0	0	1	0	0	0	74	1059
8:05 AM	0	42	0	0	0	39	0	0	0	0	0	0	0	4	0	0	0	85	1071
8:10 AM	0	55	4	0	0	42	0	0	0	0	0	0	0	0	0	1	0	102	1085
8:15 AM	0	66	0	0	0	41	0	0	0	0	0	0	0	0	0	0	0	107	1111
8:20 AM	0	73	1	0	0	44	0	0	0	0	0	0	0	0	0	1	0	119	1139
8:25 AM	0	49	4	0	0	42	0	0	0	0	0	0	0	1	0	1	0	97	1158
8:30 AM	0	38	1	0	0	48	0	1	0	0	0	0	0	0	0	0	0	88	1167
8:35 AM	0	50	1	0	0	65	0	0	0	0	0	0	0	3	0	1	0	120	1195
8:40 AM	0	52	2	0	0	57	0	0	0	0	0	0	0	0	0	1	0	112	1207
8:45 AM	0	37	1	0	0	31	0	0	0	0	0	0	0	1	0	0	0	70	1176
8:50 AM	0	40	1	0	0	38	0	0	0	0	0	0	0	0	0	0	0	79	1139
8:55 AM	0	39	0	0	0	39	0	0	0	0	0	0	0	1	0	0	0	79	1132
Peak 15-Min Flowrates	Northbound				Southbound				Eastbound				Westbound				Total		
	Left	Thru	Right	U	Left	Thru	Right	U	Left	Thru	Right	U	Left	Thru	Right	U			
All Vehicles	0	776	20	0	0	508	0	0	0	0	0	0	0	0	0	8	0	1312	
Heavy Trucks	0	40	0	0	0	4	0	0	0	0	0	0	0	0	0	0	0	44	
Pedestrians	0	0	0	0	0	0	0	0	0	0	0	0	0	0	0	0	0	0	
Bicycles	0	0	0	0	0	0	0	0	0	0	0	0	0	0	0	0	0	0	
Railroad	0	0	0	0	0	0	0	0	0	0	0	0	0	0	0	0	0	0	
Stopped Buses	0	0	0	0	0	0	0	0	0	0	0	0	0	0	0	0	0	0	

Comments:

LOCATION: Cabrillo Hwy (Hwy 1) -- 14th St
CITY/STATE: Montara, CA

QC JOB #: 14384608
DATE: Thu, Apr 20 2017

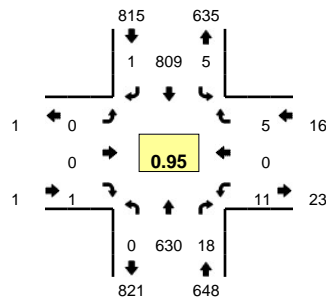

Peak-Hour: 4:45 PM -- 5:45 PM
Peak 15-Min: 4:55 PM -- 5:10 PM

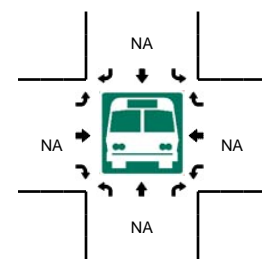
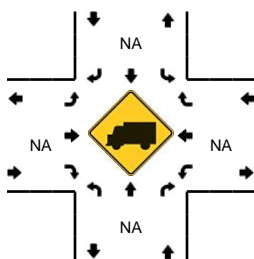
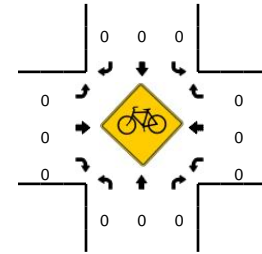
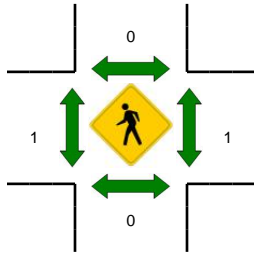
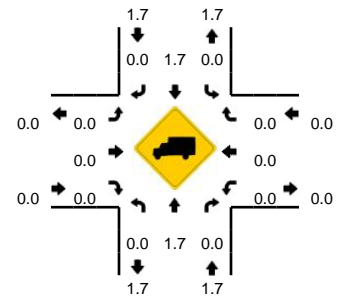

5-Min Count Period Beginning At	Cabrillo Hwy (Hwy 1) (Northbound)				Cabrillo Hwy (Hwy 1) (Southbound)				14th St (Eastbound)				14th St (Westbound)				Total	Hourly Totals
	Left	Thru	Right	U	Left	Thru	Right	U	Left	Thru	Right	U	Left	Thru	Right	U		
4:00 PM	0	69	2	0	0	69	0	0	0	0	0	0	3	0	1	0	144	
4:05 PM	0	53	2	0	0	69	0	0	0	0	0	0	0	0	0	0	124	
4:10 PM	0	47	3	0	1	51	0	0	0	0	0	0	0	0	0	0	102	
4:15 PM	1	56	1	0	1	72	0	0	0	0	0	0	0	0	0	0	131	
4:20 PM	0	55	0	0	1	51	0	0	1	0	0	0	3	0	0	0	111	
4:25 PM	0	55	1	0	0	62	0	0	0	0	0	0	1	0	0	0	119	
4:30 PM	1	51	1	0	1	49	0	0	1	0	0	0	0	0	0	0	104	
4:35 PM	0	55	0	0	0	68	0	0	0	0	0	0	0	0	0	0	123	
4:40 PM	0	43	1	0	0	54	0	0	0	0	0	0	0	0	1	0	99	
4:45 PM	0	49	1	0	0	86	0	0	0	0	0	0	1	0	1	0	138	
4:50 PM	0	51	2	0	1	62	0	0	0	0	0	0	0	0	2	0	118	
4:55 PM	0	45	2	0	2	79	0	0	0	0	0	0	0	0	0	0	128	1441
5:00 PM	0	61	1	0	0	65	0	0	0	0	0	0	2	0	0	0	129	1426
5:05 PM	0	60	2	0	0	70	0	0	0	0	0	0	2	0	0	0	134	1436
5:10 PM	0	42	0	0	0	57	0	0	0	0	0	0	1	0	2	0	102	1436
5:15 PM	0	57	2	0	0	66	0	0	0	0	1	0	1	0	0	0	127	1432
5:20 PM	0	53	0	0	1	65	0	0	0	0	0	0	1	0	0	0	120	1441
5:25 PM	0	53	1	0	0	75	0	0	0	0	0	0	0	0	0	0	129	1451
5:30 PM	0	48	3	0	0	49	0	0	0	0	0	0	0	0	0	0	100	1447
5:35 PM	0	58	2	0	0	77	1	0	0	0	0	0	2	0	0	0	140	1464
5:40 PM	0	53	2	0	1	58	0	0	0	0	0	0	1	0	0	0	115	1480
5:45 PM	0	41	1	0	1	54	0	0	0	0	0	0	0	0	0	0	97	1439
5:50 PM	1	49	2	0	0	67	0	0	0	0	0	0	0	0	0	0	119	1440
5:55 PM	1	55	6	0	0	71	0	0	0	0	0	0	1	0	0	0	134	1446
Peak 15-Min Flowrates	Northbound				Southbound				Eastbound				Westbound				Total	
	Left	Thru	Right	U	Left	Thru	Right	U	Left	Thru	Right	U	Left	Thru	Right	U		
All Vehicles	0	664	20	0	8	856	0	0	0	0	0	0	16	0	0	0	1564	
Heavy Trucks	0	20	0	0	0	8	0	0	0	0	0	0	0	0	0	0	28	
Pedestrians	0	0	0	0	0	0	0	0	0	0	0	0	0	0	0	0	0	
Bicycles	0	0	0	0	0	0	0	0	0	0	0	0	0	0	0	0	0	
Railroad	0	0	0	0	0	0	0	0	0	0	0	0	0	0	0	0	0	
Stopped Buses	0	0	0	0	0	0	0	0	0	0	0	0	0	0	0	0	0	

Comments:

LOCATION: Cabrillo Hwy (Hwy 1) -- 14th St
CITY/STATE: Montara, CA

QC JOB #: 14384609
DATE: Sat, Apr 22 2017

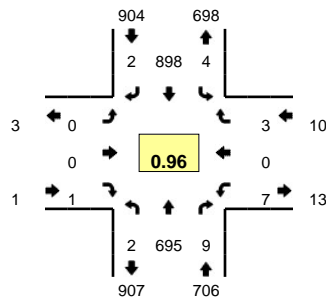

Peak-Hour: 11:55 AM -- 12:55 PM
Peak 15-Min: 11:55 AM -- 12:10 PM

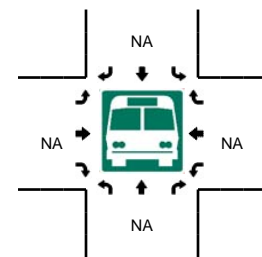
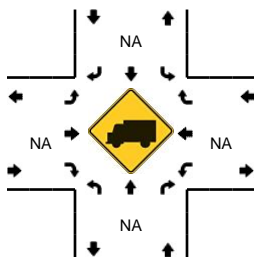
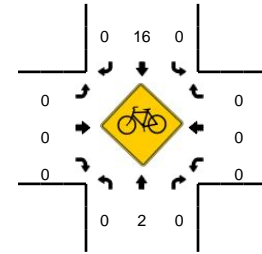
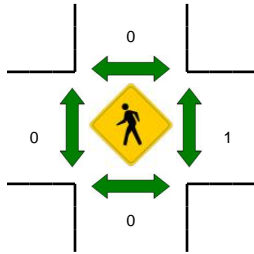
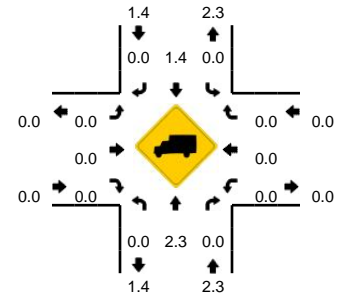

5-Min Count Period Beginning At	Cabrillo Hwy (Hwy 1) (Northbound)				Cabrillo Hwy (Hwy 1) (Southbound)				14th St (Eastbound)				14th St (Westbound)				Total	Hourly Totals	
	Left	Thru	Right	U	Left	Thru	Right	U	Left	Thru	Right	U	Left	Thru	Right	U			
11:00 AM	0	53	0	0	0	62	0	0	0	0	0	0	1	0	0	0	116		
11:05 AM	0	50	1	0	0	76	0	0	0	0	0	0	3	0	0	0	130		
11:10 AM	0	59	1	0	0	72	0	0	0	0	0	0	0	0	0	0	132		
11:15 AM	0	60	2	0	0	61	1	0	0	0	0	0	2	0	1	0	127		
11:20 AM	0	50	1	0	0	82	0	0	1	0	0	0	1	0	0	0	135		
11:25 AM	0	70	2	0	0	73	0	0	0	0	0	0	0	0	0	0	145		
11:30 AM	0	37	0	0	0	82	0	0	0	0	0	0	0	0	1	0	120		
11:35 AM	0	58	0	0	0	73	0	0	0	0	0	0	0	0	0	0	131		
11:40 AM	0	37	1	0	0	89	0	0	0	0	0	0	1	0	0	0	128		
11:45 AM	0	45	0	0	0	71	0	0	0	0	0	0	1	0	0	0	117		
11:50 AM	0	41	0	0	0	72	0	0	0	0	0	0	0	0	1	0	114		
11:55 AM	0	50	1	0	0	89	0	0	0	0	0	0	0	0	0	0	140	1535	
12:00 PM	0	69	1	0	2	86	0	0	0	0	0	0	1	0	0	0	159	1578	
12:05 PM	0	42	1	0	0	81	0	0	0	0	0	0	0	0	0	0	124	1572	
12:10 PM	0	59	1	0	1	71	0	0	0	0	0	0	0	0	0	0	132	1572	
12:15 PM	0	61	2	0	1	77	0	0	0	0	0	0	0	0	0	0	141	1586	
12:20 PM	0	58	0	0	0	79	0	0	0	0	0	0	0	0	0	0	137	1588	
12:25 PM	0	55	0	0	0	72	0	0	0	0	0	0	2	0	1	0	130	1573	
12:30 PM	0	72	0	0	0	54	0	0	0	0	0	0	1	0	1	0	128	1581	
12:35 PM	0	49	1	0	0	75	1	0	0	0	0	0	1	0	0	0	127	1577	
12:40 PM	1	53	2	0	0	64	1	0	0	0	1	0	1	0	0	0	123	1572	
12:45 PM	0	64	0	1	0	69	0	0	0	0	0	0	0	0	0	0	134	1589	
12:50 PM	0	63	0	0	0	81	0	0	0	0	0	0	1	0	1	0	146	1621	
12:55 PM	0	53	0	0	0	62	0	0	1	0	0	0	2	0	0	0	118	1599	
Peak 15-Min Flowrates	Northbound				Southbound				Eastbound				Westbound				Total		
	Left	Thru	Right	U	Left	Thru	Right	U	Left	Thru	Right	U	Left	Thru	Right	U			
All Vehicles	0	644	12	0	8	1024	0	0	0	0	0	0	4	0	0	0	1692		
Heavy Trucks	0	12	0	0	0	4	0	0	0	0	0	0	0	0	0	0	16		
Pedestrians	0	0	0	0	0	0	0	0	0	0	0	0	0	0	0	0	0		
Bicycles	0	0	0	0	0	5	0	0	0	0	0	0	0	0	0	0	5		
Railroad																			
Stopped Buses																			

Comments:

LOCATION: Cabrillo Hwy (Hwy 1) -- 16th St
CITY/STATE: Montara, CA

QC JOB #: 14384604
DATE: Thu, Apr 20 2017

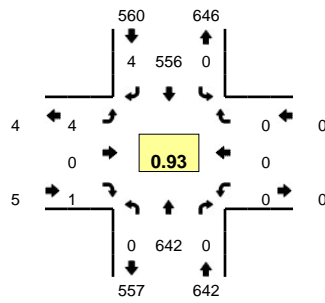

Peak-Hour: 7:45 AM -- 8:45 AM
Peak 15-Min: 8:10 AM -- 8:25 AM

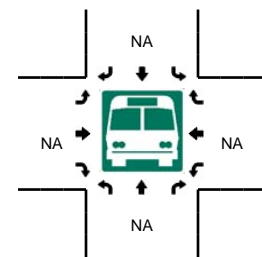
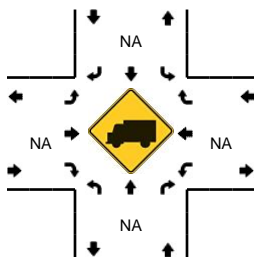
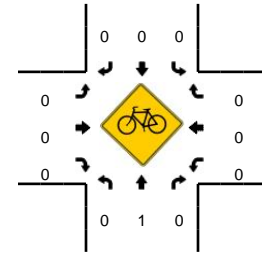
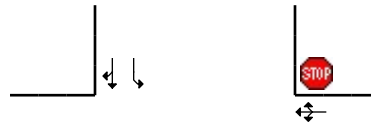
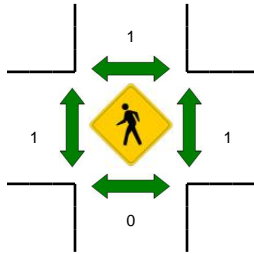
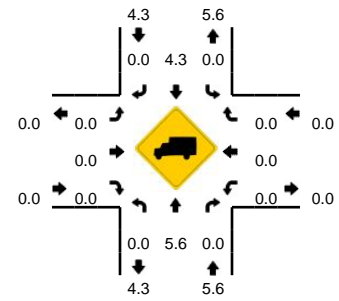

5-Min Count Period Beginning At	Cabrillo Hwy (Hwy 1) (Northbound)				Cabrillo Hwy (Hwy 1) (Southbound)				16th St (Eastbound)				16th St (Westbound)				Total	Hourly Totals
	Left	Thru	Right	U	Left	Thru	Right	U	Left	Thru	Right	U	Left	Thru	Right	U		
7:00 AM	0	58	0	0	0	21	0	0	0	0	0	0	0	0	0	0	79	
7:05 AM	0	55	0	0	0	24	1	0	0	0	0	0	0	0	0	0	80	
7:10 AM	0	47	0	0	0	35	0	0	0	0	0	0	0	0	0	0	82	
7:15 AM	0	55	0	0	0	25	0	0	0	0	0	0	0	0	0	0	80	
7:20 AM	0	43	0	0	0	25	0	0	0	0	0	0	0	0	0	0	68	
7:25 AM	2	46	0	0	0	31	0	0	0	0	0	0	0	0	0	0	79	
7:30 AM	0	53	0	0	0	22	0	0	1	0	0	0	0	0	0	0	76	
7:35 AM	0	51	0	0	0	45	0	0	1	0	0	0	1	0	0	0	98	
7:40 AM	0	56	0	0	0	35	0	0	0	0	0	0	0	0	0	0	91	
7:45 AM	0	58	0	0	0	49	1	0	0	0	0	0	0	0	0	0	108	
7:50 AM	0	57	0	0	0	57	1	0	3	0	0	0	0	0	0	0	118	
7:55 AM	0	48	0	0	0	35	0	0	0	0	0	0	0	0	0	0	83	1042
8:00 AM	0	48	0	0	0	23	0	0	0	0	1	0	0	0	0	0	72	1035
8:05 AM	0	44	0	0	0	44	0	0	0	0	0	0	0	0	0	0	88	1043
8:10 AM	0	59	0	0	0	45	0	0	0	0	0	0	0	0	0	0	104	1065
8:15 AM	0	62	0	0	0	42	0	0	0	0	0	0	0	0	0	0	104	1089
8:20 AM	0	71	0	0	0	43	1	0	0	0	0	0	0	0	0	0	115	1136
8:25 AM	0	56	0	0	0	45	0	0	0	0	0	0	0	0	0	0	101	1158
8:30 AM	0	35	0	0	0	46	1	0	0	0	0	0	0	0	0	0	82	1164
8:35 AM	0	50	0	0	0	71	0	0	1	0	0	0	0	0	0	0	122	1188
8:40 AM	0	54	0	0	0	56	0	0	0	0	0	0	0	0	0	0	110	1207
8:45 AM	0	33	0	0	0	33	1	0	0	0	0	0	0	0	0	0	67	1166
8:50 AM	0	45	0	0	0	41	1	0	0	0	0	0	0	0	0	0	87	1135
8:55 AM	0	36	0	0	0	40	0	0	1	0	0	0	1	0	1	0	79	1131
Peak 15-Min Flowrates	Northbound				Southbound				Eastbound				Westbound				Total	
	Left	Thru	Right	U	Left	Thru	Right	U	Left	Thru	Right	U	Left	Thru	Right	U		
All Vehicles	0	768	0	0	0	520	4	0	0	0	0	0	0	0	0	0	1292	
Heavy Trucks	0	44	0	0	0	8	0	0	0	0	0	0	0	0	0	0	52	
Pedestrians	0	0	0	0	0	0	0	0	0	0	0	0	0	0	0	0	0	
Bicycles	0	1	0	0	0	0	0	0	0	0	0	0	0	0	0	0	1	
Railroad																		
Stopped Buses																		

Comments:

LOCATION: Cabrillo Hwy (Hwy 1) -- 16th St
CITY/STATE: Montara, CA

QC JOB #: 14384605
DATE: Thu, Apr 20 2017

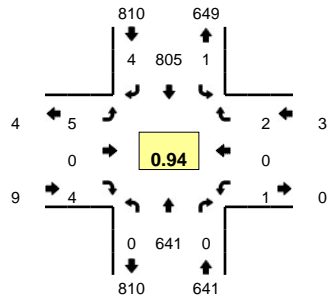

Peak-Hour: 4:45 PM -- 5:45 PM
Peak 15-Min: 4:55 PM -- 5:10 PM

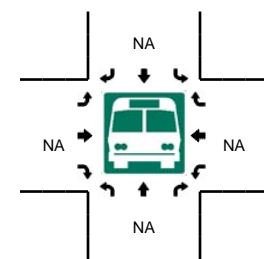
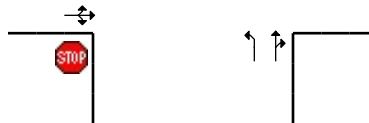
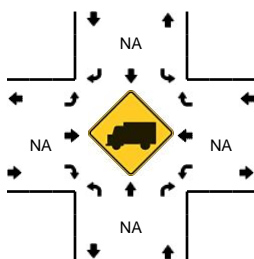
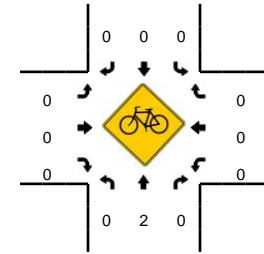
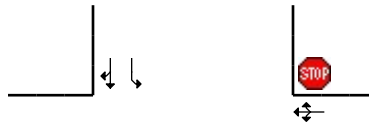
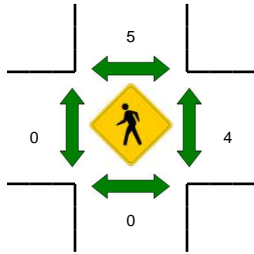
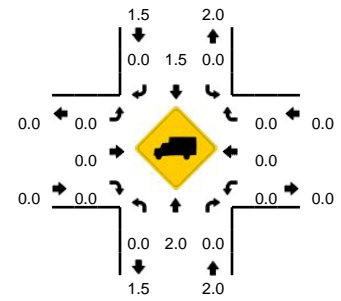

5-Min Count Period Beginning At	Cabrillo Hwy (Hwy 1) (Northbound)				Cabrillo Hwy (Hwy 1) (Southbound)				16th St (Eastbound)				16th St (Westbound)				Total	Hourly Totals	
	Left	Thru	Right	U	Left	Thru	Right	U	Left	Thru	Right	U	Left	Thru	Right	U			
4:00 PM	0	58	0	0	0	70	0	0	2	0	2	0	0	0	0	0	132		
4:05 PM	0	53	0	0	0	71	0	0	0	0	1	0	0	0	0	0	125		
4:10 PM	1	50	0	0	0	48	0	0	0	0	0	0	0	0	0	0	99		
4:15 PM	0	56	0	0	0	72	2	0	1	0	0	0	0	0	0	0	131		
4:20 PM	0	56	0	0	0	55	1	0	0	0	0	0	0	0	0	0	112		
4:25 PM	0	55	0	0	0	58	1	0	0	0	0	0	0	0	0	0	114		
4:30 PM	1	53	0	0	0	53	0	0	4	0	0	0	0	0	0	0	111		
4:35 PM	0	49	1	0	0	64	0	0	0	0	0	0	0	0	0	0	114		
4:40 PM	0	45	0	0	0	61	0	0	0	0	0	0	0	0	0	0	106		
4:45 PM	0	55	0	0	0	79	0	0	0	0	0	0	0	0	1	0	135		
4:50 PM	0	45	0	0	0	62	0	0	0	0	0	0	0	0	0	0	107		
4:55 PM	0	45	0	0	0	82	0	0	0	0	0	0	0	0	0	0	127	1413	
5:00 PM	0	68	0	0	0	64	1	0	1	0	0	0	0	0	0	0	134	1415	
5:05 PM	0	52	0	0	0	70	2	1	2	0	0	0	0	0	0	0	127	1417	
5:10 PM	0	51	0	0	0	59	0	0	0	0	2	0	0	0	0	0	112	1430	
5:15 PM	0	53	0	0	0	64	1	0	0	0	0	0	0	0	0	0	118	1417	
5:20 PM	0	56	0	0	0	67	0	0	0	0	1	0	0	0	0	0	124	1429	
5:25 PM	0	49	0	0	0	76	0	0	1	0	0	0	0	0	0	0	126	1441	
5:30 PM	0	52	0	0	0	49	0	0	1	0	0	0	1	0	1	0	104	1434	
5:35 PM	0	62	0	0	0	74	0	0	0	0	1	0	0	0	0	0	137	1457	
5:40 PM	0	53	0	0	0	59	0	0	0	0	0	0	0	0	0	0	112	1463	
5:45 PM	0	37	0	0	0	57	0	0	0	0	0	0	0	0	0	0	94	1422	
5:50 PM	0	53	0	0	0	65	0	0	0	0	0	0	0	0	0	0	118	1433	
5:55 PM	0	62	0	0	1	73	1	0	0	0	0	0	0	0	0	0	137	1443	
Peak 15-Min Flowrates	Northbound				Southbound				Eastbound				Westbound				Total		
	Left	Thru	Right	U	Left	Thru	Right	U	Left	Thru	Right	U	Left	Thru	Right	U			
All Vehicles	0	660	0	0	0	864	12	4	12	0	0	0	0	0	0	0	1552		
Heavy Trucks	0	28	0	0	0	8	0	0	0	0	0	0	0	0	0	0	36		
Pedestrians		0				12				0				4			16		
Bicycles	0	0	0		0	0	0		0	0	0		0	0	0		0		
Railroad																			
Stopped Buses																			

Comments:

LOCATION: Cabrillo Hwy (Hwy 1) -- 16th St
CITY/STATE: Montara, CA

QC JOB #: 14384606
DATE: Sat, Apr 22 2017

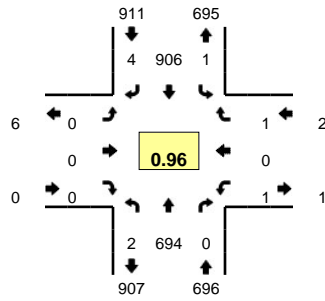

Peak-Hour: 11:55 AM -- 12:55 PM
Peak 15-Min: 12:10 PM -- 12:25 PM

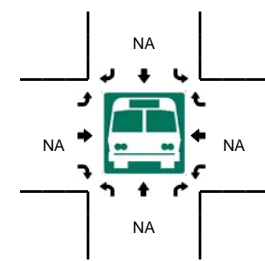
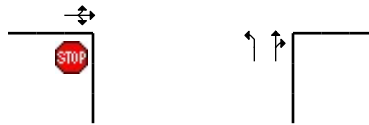
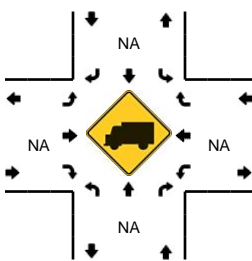
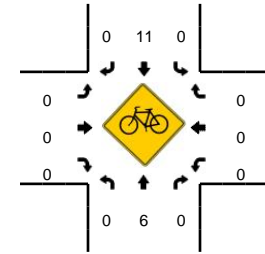
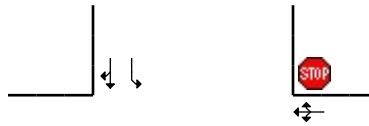
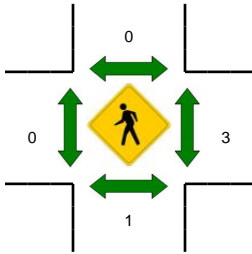
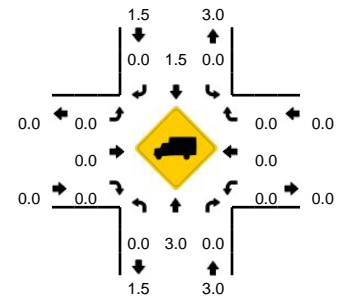

5-Min Count Period Beginning At	Cabrillo Hwy (Hwy 1) (Northbound)				Cabrillo Hwy (Hwy 1) (Southbound)				16th St (Eastbound)				16th St (Westbound)				Total	Hourly Totals	
	Left	Thru	Right	U	Left	Thru	Right	U	Left	Thru	Right	U	Left	Thru	Right	U			
11:00 AM	0	54	0	0	0	67	0	0	0	0	0	0	0	0	0	0	121		
11:05 AM	0	59	0	0	0	77	0	0	0	0	0	0	0	0	0	0	136		
11:10 AM	0	53	0	0	0	75	0	0	0	0	0	0	0	0	0	0	128		
11:15 AM	0	62	0	0	0	62	0	0	0	0	0	0	0	0	0	0	124		
11:20 AM	0	49	0	0	0	84	1	0	0	0	0	0	0	0	0	0	134		
11:25 AM	0	69	0	0	0	71	0	0	0	0	0	1	0	0	0	0	141		
11:30 AM	0	44	0	0	0	82	2	0	0	0	0	1	0	0	0	0	129		
11:35 AM	0	51	0	0	0	75	0	0	0	0	0	0	0	0	0	0	126		
11:40 AM	1	38	0	0	0	88	0	0	1	0	1	0	1	0	0	0	130		
11:45 AM	0	43	0	0	0	73	0	0	0	0	0	0	0	0	0	0	116		
11:50 AM	0	45	0	0	0	70	0	0	1	0	0	0	0	0	0	0	116		
11:55 AM	0	48	0	0	0	93	0	0	0	0	0	0	0	0	0	0	141	1542	
12:00 PM	0	68	0	0	0	81	0	0	0	0	0	0	0	0	0	0	149	1570	
12:05 PM	0	42	0	0	1	82	0	0	0	0	0	0	0	0	0	0	125	1559	
12:10 PM	1	68	0	0	0	72	0	0	0	0	0	0	0	0	0	0	141	1572	
12:15 PM	0	58	0	0	0	80	0	0	0	0	0	0	0	0	0	0	138	1586	
12:20 PM	0	60	0	0	0	78	0	0	0	0	0	0	0	0	0	0	138	1590	
12:25 PM	0	54	0	0	0	74	0	0	0	0	0	0	0	0	0	0	128	1577	
12:30 PM	1	69	0	0	0	55	0	0	0	0	0	0	0	0	0	0	125	1573	
12:35 PM	0	47	0	0	0	76	0	0	0	0	0	0	0	0	0	0	123	1570	
12:40 PM	0	51	0	0	0	63	1	0	0	0	0	0	0	1	0	0	116	1556	
12:45 PM	0	70	0	0	0	71	2	0	0	0	0	0	1	0	0	0	144	1584	
12:50 PM	0	59	0	0	0	81	1	0	0	0	0	0	0	0	0	0	141	1609	
12:55 PM	1	56	0	0	0	67	0	0	0	0	0	2	0	0	0	0	126	1594	
Peak 15-Min Flowrates	Northbound				Southbound				Eastbound				Westbound				Total		
	Left	Thru	Right	U	Left	Thru	Right	U	Left	Thru	Right	U	Left	Thru	Right	U			
All Vehicles	4	744	0	0	0	920	0	0	0	0	0	0	0	0	0	0	1668		
Heavy Trucks	0	12	0	0	0	8	0	0	0	0	0	0	0	0	0	0	20		
Pedestrians		0				0					0						0		
Bicycles	0	3	0		0	1	0		0	0	0		0	0	0		4		
Railroad																			
Stopped Buses																			

Comments:

LOCATION: Cabrillo Hwy (Hwy 1) -- Carlos St
CITY/STATE: Montara, CA

QC JOB #: 14384601
DATE: Thu, Apr 20 2017

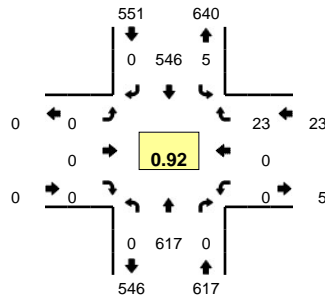

Peak-Hour: 7:45 AM -- 8:45 AM
Peak 15-Min: 8:10 AM -- 8:25 AM

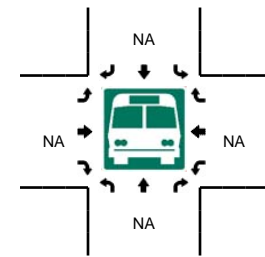
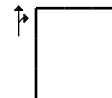
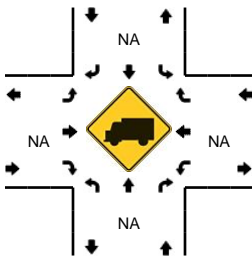
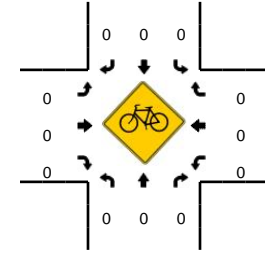
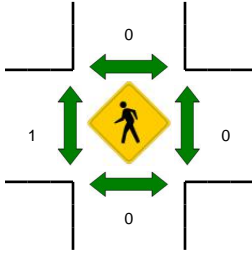
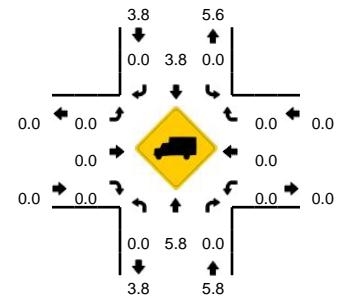

5-Min Count Period Beginning At	Cabrillo Hwy (Hwy 1) (Northbound)				Cabrillo Hwy (Hwy 1) (Southbound)				Carlos St (Eastbound)				Carlos St (Westbound)				Total	Hourly Totals	
	Left	Thru	Right	U	Left	Thru	Right	U	Left	Thru	Right	U	Left	Thru	Right	U			
7:00 AM	0	55	0	0	0	23	0	0	0	0	0	0	0	0	0	4	0	82	
7:05 AM	0	50	0	0	1	23	0	0	0	0	0	0	0	0	0	0	0	74	
7:10 AM	0	49	0	0	0	33	0	0	0	0	0	0	0	0	0	0	0	82	
7:15 AM	0	53	0	0	1	25	0	0	0	0	0	0	0	0	0	3	0	82	
7:20 AM	0	62	0	0	0	28	0	0	0	0	0	0	0	0	0	2	0	92	
7:25 AM	0	44	0	0	0	27	0	0	0	0	0	0	0	0	0	3	0	74	
7:30 AM	0	54	0	0	1	23	0	0	0	0	0	0	0	0	0	0	0	78	
7:35 AM	0	50	0	0	1	40	0	0	0	0	0	0	0	0	0	0	0	91	
7:40 AM	0	59	0	0	0	39	0	0	0	0	0	0	0	0	0	1	0	99	
7:45 AM	0	53	0	0	0	46	0	0	0	0	0	0	0	0	0	1	0	100	
7:50 AM	0	57	0	0	1	57	0	0	0	0	0	0	0	0	0	2	0	117	
7:55 AM	0	44	0	0	0	36	0	0	0	0	0	0	0	0	0	2	0	82	1053
8:00 AM	0	50	0	0	0	24	0	0	0	0	0	0	0	0	0	1	0	75	1046
8:05 AM	0	38	0	0	0	42	0	0	0	0	0	0	0	0	0	3	0	83	1055
8:10 AM	0	56	0	0	0	41	0	0	0	0	0	0	0	0	0	3	0	100	1073
8:15 AM	0	64	0	0	0	45	0	0	0	0	0	0	0	0	0	1	0	110	1101
8:20 AM	0	71	0	0	2	40	0	0	0	0	0	0	0	0	0	1	0	114	1123
8:25 AM	0	49	0	0	0	42	0	0	0	0	0	0	0	0	0	5	0	96	1145
8:30 AM	0	37	0	0	0	50	0	0	0	0	0	0	0	0	0	1	0	88	1155
8:35 AM	0	51	0	0	2	67	0	0	0	0	0	0	0	0	0	0	0	120	1184
8:40 AM	0	47	0	0	0	56	0	0	0	0	0	0	0	0	0	3	0	106	1191
8:45 AM	0	39	0	0	0	37	0	0	0	0	0	0	0	0	0	0	0	76	1167
8:50 AM	0	40	0	0	0	40	0	0	0	0	0	0	0	0	0	0	0	80	1130
8:55 AM	0	37	0	0	0	39	0	0	0	0	0	0	0	0	0	0	0	76	1124
Peak 15-Min Flowrates	Northbound				Southbound				Eastbound				Westbound				Total		
	Left	Thru	Right	U	Left	Thru	Right	U	Left	Thru	Right	U	Left	Thru	Right	U			
All Vehicles	0	764	0	0	8	504	0	0	0	0	0	0	0	0	0	20	0	1296	
Heavy Trucks	0	44	0	0	0	8	0	0	0	0	0	0	0	0	0	0	0	52	
Pedestrians	0	0	0	0	0	0	0	0	0	0	0	0	0	0	0	0	0	0	
Bicycles	0	0	0	0	0	0	0	0	0	0	0	0	0	0	0	0	0	0	
Railroad																			
Stopped Buses																			

Comments:

Type of peak hour being reported: Intersection Peak

Method for determining peak hour: Total Entering Volume

LOCATION: Cabrillo Hwy (Hwy 1) -- Carlos St
CITY/STATE: Montara, CA

QC JOB #: 14384602
DATE: Thu, Apr 20 2017

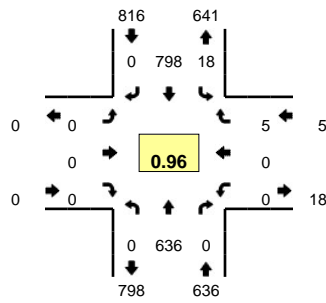

Peak-Hour: 4:45 PM -- 5:45 PM
Peak 15-Min: 4:55 PM -- 5:10 PM

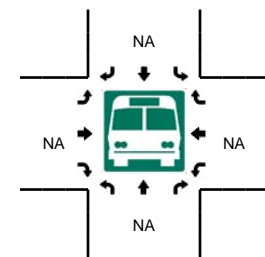
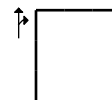
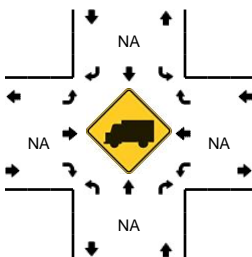
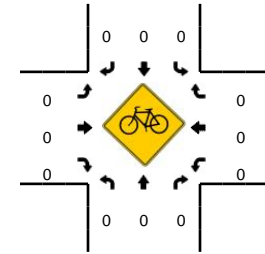
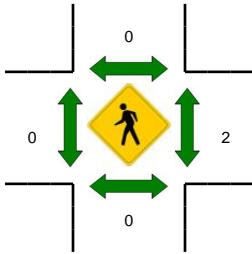
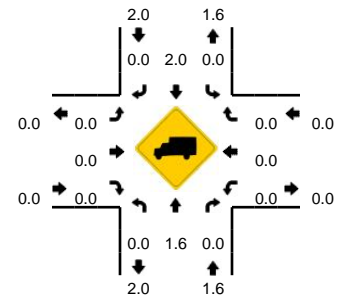

5-Min Count Period Beginning At	Cabrillo Hwy (Hwy 1) (Northbound)				Cabrillo Hwy (Hwy 1) (Southbound)				Carlos St (Eastbound)				Carlos St (Westbound)				Total	Hourly Totals	
	Left	Thru	Right	U	Left	Thru	Right	U	Left	Thru	Right	U	Left	Thru	Right	U			
4:00 PM	0	66	0	0	0	76	0	0	0	0	0	0	0	0	0	1	0	143	
4:05 PM	0	53	0	0	2	69	0	0	0	0	0	0	0	0	0	1	0	125	
4:10 PM	0	51	0	0	0	47	0	0	0	0	0	0	0	0	0	0	0	98	
4:15 PM	0	57	0	0	1	70	0	0	0	0	0	0	0	0	0	0	0	128	
4:20 PM	0	53	0	0	1	44	0	0	0	0	0	0	0	0	0	1	0	99	
4:25 PM	0	57	0	0	0	73	0	0	0	0	0	0	0	0	0	0	0	130	
4:30 PM	0	50	0	0	1	44	0	0	0	0	0	0	0	0	0	1	0	96	
4:35 PM	0	56	0	0	1	70	0	0	0	0	0	0	0	0	0	0	0	127	
4:40 PM	0	42	0	0	0	58	0	0	0	0	0	0	0	0	0	0	0	100	
4:45 PM	0	50	0	0	2	76	0	0	0	0	0	0	0	0	0	0	0	128	
4:50 PM	0	52	0	0	3	61	0	0	0	0	0	0	0	0	0	0	0	116	
4:55 PM	0	47	0	0	0	79	0	0	0	0	0	0	0	0	0	0	0	126	1416
5:00 PM	0	62	0	0	1	62	0	0	0	0	0	0	0	0	0	0	0	125	1398
5:05 PM	0	59	0	0	3	65	0	0	0	0	0	0	0	0	0	0	0	127	1400
5:10 PM	0	39	0	0	2	57	0	0	0	0	0	0	0	0	2	0	0	100	1402
5:15 PM	0	59	0	0	1	68	0	0	0	0	0	0	0	0	0	0	0	128	1402
5:20 PM	0	49	0	0	1	70	0	0	0	0	0	0	0	0	1	0	0	121	1424
5:25 PM	0	56	0	0	3	68	0	0	0	0	0	0	0	0	0	0	0	127	1421
5:30 PM	0	49	0	0	1	54	0	0	0	0	0	0	0	0	0	0	0	104	1429
5:35 PM	0	59	0	0	1	79	0	0	0	0	0	0	0	0	2	0	0	141	1443
5:40 PM	0	55	0	0	0	59	0	0	0	0	0	0	0	0	0	0	0	114	1457
5:45 PM	0	42	0	0	3	53	0	0	0	0	0	0	0	0	0	0	0	98	1427
5:50 PM	0	48	0	0	2	56	0	0	0	0	0	0	0	0	3	0	0	109	1420
5:55 PM	0	62	0	0	3	75	0	0	0	0	0	0	0	0	1	0	0	141	1435
Peak 15-Min Flowrates	Northbound				Southbound				Eastbound				Westbound				Total		
	Left	Thru	Right	U	Left	Thru	Right	U	Left	Thru	Right	U	Left	Thru	Right	U			
All Vehicles	0	672	0	0	16	824	0	0	0	0	0	0	0	0	0	0	0	1512	
Heavy Trucks	0	16	0	0	0	12	0	0	0	0	0	0	0	0	0	0	0	28	
Pedestrians	0	0	0	0	0	0	0	0	0	0	0	0	0	0	0	0	0	0	
Bicycles	0	0	0	0	0	0	0	0	0	0	0	0	0	0	0	0	0	0	
Railroad																			
Stopped Buses																			

Comments:

LOCATION: Cabrillo Hwy (Hwy 1) -- Carlos St
CITY/STATE: Montara, CA

QC JOB #: 14384603
DATE: Sat, Apr 22 2017

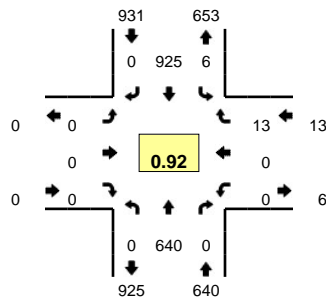

Peak-Hour: 11:35 AM -- 12:35 PM
Peak 15-Min: 12:15 PM -- 12:30 PM

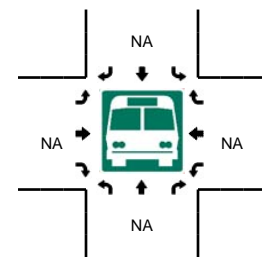
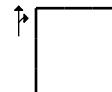
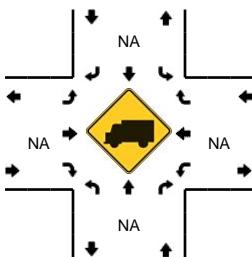
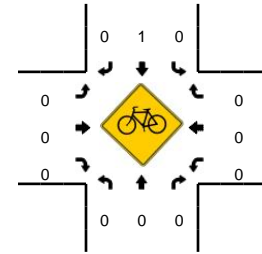
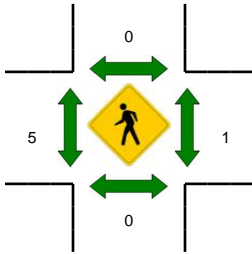
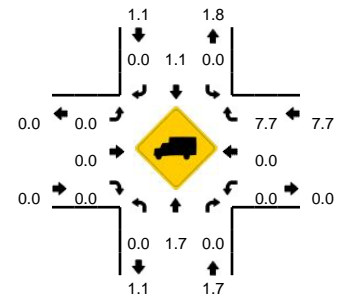

5-Min Count Period Beginning At	Cabrillo Hwy (Hwy 1) (Northbound)				Cabrillo Hwy (Hwy 1) (Southbound)				Carlos St (Eastbound)				Carlos St (Westbound)				Total	Hourly Totals	
	Left	Thru	Right	U	Left	Thru	Right	U	Left	Thru	Right	U	Left	Thru	Right	U			
11:00 AM	0	50	0	0	2	61	0	0	0	0	0	0	0	0	0	1	0	114	
11:05 AM	0	57	0	0	0	82	0	0	0	0	0	0	0	0	0	0	0	139	
11:10 AM	0	60	0	0	0	74	0	0	0	0	0	0	0	0	0	0	0	134	
11:15 AM	0	54	0	0	0	64	0	0	0	0	0	0	0	0	0	0	0	118	
11:20 AM	0	56	0	0	0	84	0	0	0	0	0	0	0	0	1	0	0	141	
11:25 AM	0	69	0	0	1	64	0	0	0	0	0	0	0	0	0	0	0	134	
11:30 AM	0	39	0	0	0	82	0	0	0	0	0	0	0	0	1	0	0	122	
11:35 AM	0	51	0	0	0	80	0	0	0	0	0	0	0	0	1	0	0	132	
11:40 AM	0	42	0	0	1	80	0	0	0	0	0	0	0	0	0	0	0	123	
11:45 AM	0	47	0	0	0	84	0	0	0	0	0	0	0	0	1	0	0	132	
11:50 AM	0	38	0	0	0	68	0	0	0	0	0	0	0	0	2	0	0	108	
11:55 AM	0	47	0	0	2	79	0	0	0	0	0	0	0	0	1	0	0	129	1526
12:00 PM	0	62	0	0	0	88	0	0	0	0	0	0	0	0	2	0	0	152	1564
12:05 PM	0	47	0	0	0	83	0	0	0	0	0	0	0	0	0	0	0	130	1555
12:10 PM	0	49	0	0	0	71	0	0	0	0	0	0	0	0	1	0	0	121	1542
12:15 PM	0	79	0	0	2	75	0	0	0	0	0	0	0	0	1	0	0	157	1581
12:20 PM	0	42	0	0	0	79	0	0	0	0	0	0	0	0	0	0	0	121	1561
12:25 PM	0	61	0	0	1	89	0	0	0	0	0	0	0	0	1	0	0	152	1579
12:30 PM	0	75	0	0	0	49	0	0	0	0	0	0	0	0	3	0	0	127	1584
12:35 PM	0	45	0	0	0	70	0	0	0	0	0	0	0	0	2	0	0	117	1569
12:40 PM	0	57	0	0	1	49	0	0	0	0	0	0	0	0	0	0	0	107	1553
12:45 PM	0	63	0	0	1	62	0	0	0	0	0	0	0	0	0	0	0	126	1547
12:50 PM	0	62	0	0	1	75	0	0	0	0	0	0	0	0	0	0	0	138	1577
12:55 PM	0	59	0	0	1	60	0	0	0	0	0	0	0	0	0	0	0	120	1568
Peak 15-Min Flowrates	Northbound				Southbound				Eastbound				Westbound				Total		
	Left	Thru	Right	U	Left	Thru	Right	U	Left	Thru	Right	U	Left	Thru	Right	U			
All Vehicles	0	728	0	0	12	972	0	0	0	0	0	0	0	0	8	0	0	1720	
Heavy Trucks	0	4	0	0	0	8	0	0	0	0	0	0	0	0	0	0	0	12	
Pedestrians	0	0	0	0	0	0	0	0	0	0	0	0	0	4	0	0	0	4	
Bicycles	0	0	0	0	0	0	0	0	0	0	0	0	0	0	0	0	0	0	
Railroad																			
Stopped Buses																			

Comments:

LOCATION: Carlos St -- Sierra St
CITY/STATE: San Mateo, CA

QC JOB #: 14384619
DATE: Thu, Apr 20 2017

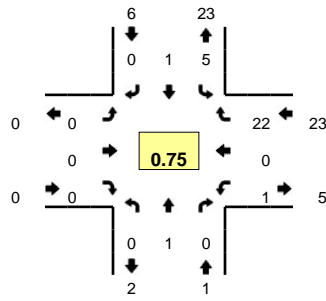

Peak-Hour: 7:45 AM -- 8:45 AM
Peak 15-Min: 8:15 AM -- 8:30 AM

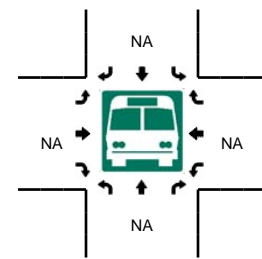
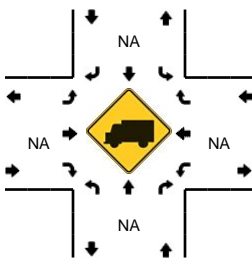
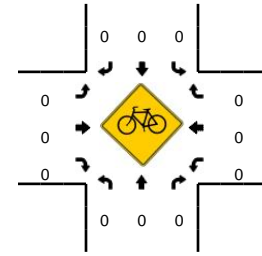
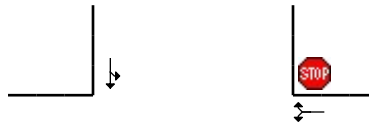
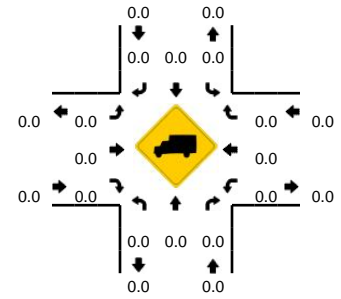

5-Min Count Period Beginning At	Carlos St (Northbound)				Carlos St (Southbound)				Sierra St (Eastbound)				Sierra St (Westbound)				Total	Hourly Totals	
	Left	Thru	Right	U	Left	Thru	Right	U	Left	Thru	Right	U	Left	Thru	Right	U			
7:00 AM	0	0	0	0	0	0	0	0	0	0	0	0	0	0	0	4	0	4	
7:05 AM	0	0	0	0	1	0	0	0	0	0	0	0	0	1	0	0	0	2	
7:10 AM	0	0	0	0	0	0	0	0	0	0	0	0	0	0	0	0	0	0	
7:15 AM	0	0	0	0	1	0	0	0	0	0	0	0	0	0	0	3	0	4	
7:20 AM	0	0	0	0	0	0	0	0	0	0	0	0	0	0	0	2	0	2	
7:25 AM	0	0	0	0	0	0	0	0	0	0	0	0	0	0	0	3	0	3	
7:30 AM	0	0	0	0	0	0	0	0	0	0	0	0	0	1	0	0	0	1	
7:35 AM	0	0	1	0	0	0	0	0	0	0	0	0	0	0	0	0	0	1	
7:40 AM	0	0	0	0	1	0	0	0	0	0	0	0	0	0	0	1	0	2	
7:45 AM	0	0	0	0	0	0	0	0	0	0	0	0	0	0	0	1	0	1	
7:50 AM	0	0	0	0	1	1	0	0	0	0	0	0	0	0	0	2	0	4	
7:55 AM	0	1	0	0	0	0	0	0	0	0	0	0	0	0	0	1	0	2	26
8:00 AM	0	0	0	0	0	0	0	0	0	0	0	0	0	0	0	1	0	1	23
8:05 AM	0	0	0	0	0	0	0	0	0	0	0	0	0	0	0	3	0	3	24
8:10 AM	0	0	0	0	0	0	0	0	0	0	0	0	0	0	0	3	0	3	27
8:15 AM	0	0	0	0	0	0	0	0	0	0	0	0	0	0	0	1	0	1	24
8:20 AM	0	0	0	0	1	0	0	0	0	0	0	0	0	1	0	2	0	4	26
8:25 AM	0	0	0	0	1	0	0	0	0	0	0	0	0	0	4	0	0	5	28
8:30 AM	0	0	0	0	0	0	0	0	0	0	0	0	0	0	0	1	0	1	28
8:35 AM	0	0	0	0	1	0	0	0	0	0	0	0	0	0	0	0	0	1	28
8:40 AM	0	0	0	0	1	0	0	0	0	0	0	0	0	0	0	3	0	4	30
8:45 AM	0	0	0	0	0	0	0	0	0	0	0	0	0	0	0	0	0	0	29
8:50 AM	0	0	0	0	0	0	0	0	0	0	0	0	0	0	0	0	0	0	25
8:55 AM	0	0	0	0	0	0	0	0	0	0	0	0	0	0	0	0	0	0	23
Peak 15-Min Flowrates	Northbound				Southbound				Eastbound				Westbound				Total		
	Left	Thru	Right	U	Left	Thru	Right	U	Left	Thru	Right	U	Left	Thru	Right	U			
All Vehicles	0	0	0	0	8	0	0	0	0	0	0	0	4	0	28	0	40		
Heavy Trucks	0	0	0	0	0	0	0	0	0	0	0	0	0	0	0	0	0		
Pedestrians	0	0	0	0	0	0	0	0	0	0	0	0	0	0	0	0	0		
Bicycles	0	0	0	0	0	0	0	0	0	0	0	0	0	0	0	0	0		
Railroad																			
Stopped Buses																			

Comments:

LOCATION: Carlos St -- Sierra St
CITY/STATE: San Mateo, CA

QC JOB #: 14384620
DATE: Thu, Apr 20 2017

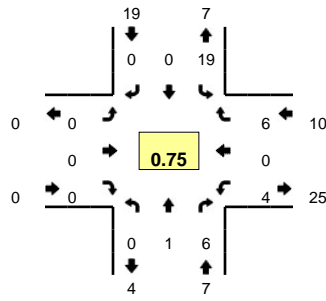

Peak-Hour: 5:00 PM -- 6:00 PM
Peak 15-Min: 5:40 PM -- 5:55 PM

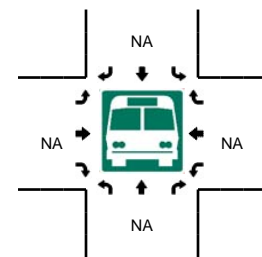
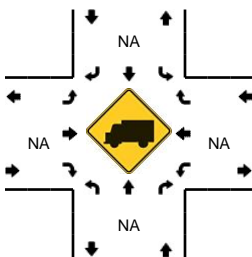
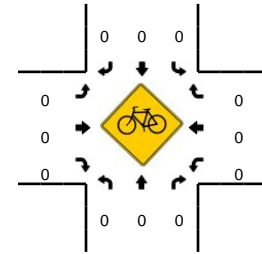
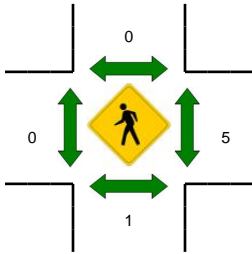
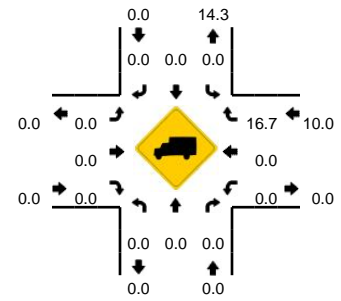

5-Min Count Period Beginning At	Carlos St (Northbound)				Carlos St (Southbound)				Sierra St (Eastbound)				Sierra St (Westbound)				Total	Hourly Totals	
	Left	Thru	Right	U	Left	Thru	Right	U	Left	Thru	Right	U	Left	Thru	Right	U			
4:00 PM	0	0	0	0	0	0	0	0	0	0	0	0	0	0	1	0	1		
4:05 PM	0	0	0	0	2	0	0	0	0	0	0	0	0	0	0	1	0	3	
4:10 PM	0	0	0	0	0	0	0	0	0	0	0	0	0	0	0	0	0	0	
4:15 PM	0	0	0	0	1	0	0	0	0	0	0	0	0	0	0	0	0	1	
4:20 PM	0	0	0	0	0	0	0	0	0	0	0	0	0	1	0	1	0	2	
4:25 PM	0	0	0	0	0	0	0	0	0	0	0	0	0	0	0	0	0	0	
4:30 PM	0	0	1	0	1	0	0	0	0	0	0	0	0	0	0	1	0	3	
4:35 PM	0	0	0	0	1	0	0	0	0	0	0	0	0	0	0	0	0	1	
4:40 PM	0	0	2	0	0	0	0	0	0	0	0	0	0	0	0	0	0	2	
4:45 PM	0	0	0	0	2	0	0	0	0	0	0	0	0	0	0	0	0	2	
4:50 PM	0	0	0	0	3	0	0	0	0	0	0	0	0	0	0	0	0	3	
4:55 PM	0	0	0	0	0	0	0	0	0	0	0	0	1	0	0	0	0	1	19
5:00 PM	0	0	2	0	1	0	0	0	0	0	0	0	1	0	0	0	0	4	22
5:05 PM	0	0	0	0	3	0	0	0	0	0	0	0	0	0	0	0	0	3	22
5:10 PM	0	0	0	0	0	0	0	0	0	0	0	0	0	0	2	0	0	2	24
5:15 PM	0	0	0	0	3	0	0	0	0	0	0	0	1	0	0	0	0	4	27
5:20 PM	0	0	0	0	1	0	0	0	0	0	0	0	1	0	1	0	0	3	28
5:25 PM	0	0	0	0	3	0	0	0	0	0	0	0	0	0	0	0	0	3	31
5:30 PM	0	0	0	0	1	0	0	0	0	0	0	0	0	0	0	0	0	1	29
5:35 PM	0	0	1	0	0	0	0	0	0	0	0	0	1	0	0	0	0	2	30
5:40 PM	0	1	1	0	0	0	0	0	0	0	0	0	0	0	0	0	0	2	30
5:45 PM	0	0	1	0	3	0	0	0	0	0	0	0	0	0	1	0	0	5	33
5:50 PM	0	0	1	0	2	0	0	0	0	0	0	0	0	0	2	0	0	5	35
5:55 PM	0	0	0	0	2	0	0	0	0	0	0	0	0	0	0	0	0	2	36
Peak 15-Min Flowrates	Northbound				Southbound				Eastbound				Westbound				Total		
	Left	Thru	Right	U	Left	Thru	Right	U	Left	Thru	Right	U	Left	Thru	Right	U			
All Vehicles	0	4	12	0	20	0	0	0	0	0	0	0	0	0	12	0	48		
Heavy Trucks	0	0	0	0	0	0	0	0	0	0	0	0	0	0	4	0	4		
Pedestrians	0	0	0	0	0	0	0	0	0	0	0	0	0	0	0	0	0		
Bicycles	0	0	0	0	0	0	0	0	0	0	0	0	0	0	0	0	0		
Railroad																			
Stopped Buses																			

Comments:

LOCATION: Carlos St -- Sierra St
CITY/STATE: San Mateo, CA

QC JOB #: 14384621
DATE: Sat, Apr 22 2017

Peak-Hour: 11:50 AM -- 12:50 PM
Peak 15-Min: 12:25 PM -- 12:40 PM

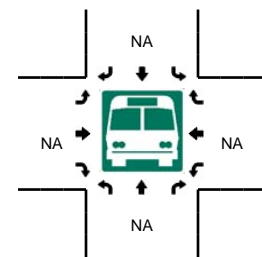
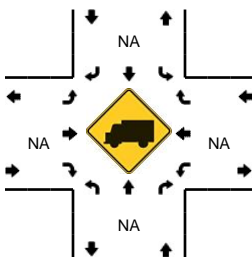
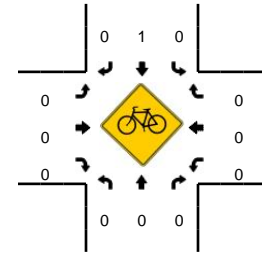
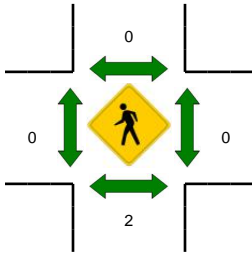
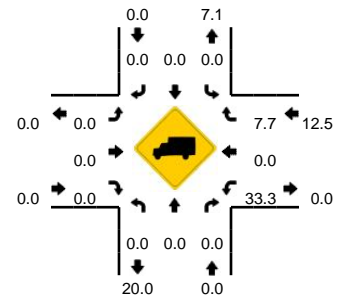
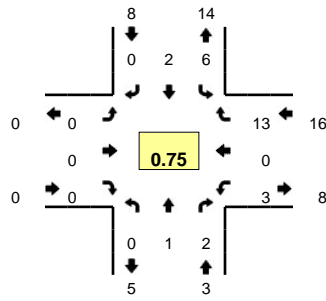

5-Min Count Period Beginning At	Carlos St (Northbound)				Carlos St (Southbound)				Sierra St (Eastbound)				Sierra St (Westbound)				Total	Hourly Totals	
	Left	Thru	Right	U	Left	Thru	Right	U	Left	Thru	Right	U	Left	Thru	Right	U			
11:00 AM	0	0	0	0	2	0	0	0	0	0	0	0	0	3	0	1	0	6	
11:05 AM	0	1	0	0	0	0	0	0	0	0	0	0	0	1	0	0	0	2	
11:10 AM	0	0	0	0	0	0	0	0	0	0	0	0	0	0	0	0	0	0	
11:15 AM	0	0	0	0	0	0	0	0	0	0	0	0	0	0	0	0	0	0	
11:20 AM	0	1	0	0	0	0	0	0	0	0	0	0	0	0	0	1	0	2	
11:25 AM	0	0	0	0	1	1	0	0	0	0	0	0	0	0	0	0	0	2	
11:30 AM	0	0	0	0	0	0	0	0	0	0	0	0	0	0	0	1	0	1	
11:35 AM	0	0	0	0	0	0	0	0	0	0	0	0	0	0	0	1	0	1	
11:40 AM	0	0	0	0	1	0	0	0	0	0	0	0	0	0	0	0	0	1	
11:45 AM	0	1	0	0	0	0	0	0	0	0	0	0	0	0	0	1	0	2	
11:50 AM	0	0	0	0	0	0	0	0	0	0	0	0	0	0	0	1	0	1	
11:55 AM	0	0	0	0	2	0	0	0	0	0	0	0	0	1	0	1	0	4	22
12:00 PM	0	0	0	0	0	0	0	0	0	0	0	0	0	0	0	3	0	3	19
12:05 PM	0	0	0	0	0	0	0	0	0	0	0	0	0	0	0	0	0	0	17
12:10 PM	0	0	0	0	0	0	0	0	0	0	0	0	0	0	0	1	0	1	18
12:15 PM	0	0	0	0	2	0	0	0	0	0	0	0	0	1	0	1	0	4	22
12:20 PM	0	0	0	0	0	1	0	0	0	0	0	0	0	0	0	0	0	1	21
12:25 PM	0	0	0	0	0	1	0	0	0	0	0	0	0	0	0	1	0	2	21
12:30 PM	0	0	0	0	0	0	0	0	0	0	0	0	0	0	0	4	0	4	24
12:35 PM	0	1	2	0	0	0	0	0	0	0	0	0	0	0	0	0	0	3	26
12:40 PM	0	0	0	0	0	0	0	0	0	0	0	0	0	0	0	0	0	0	25
12:45 PM	0	0	0	0	2	0	0	0	0	0	0	0	0	1	0	1	0	4	27
12:50 PM	0	0	0	0	1	0	0	0	0	0	0	0	0	0	0	0	0	1	27
12:55 PM	0	0	0	0	1	0	0	0	0	0	0	0	0	0	0	0	0	1	24
Peak 15-Min Flowrates	Northbound				Southbound				Eastbound				Westbound				Total		
	Left	Thru	Right	U	Left	Thru	Right	U	Left	Thru	Right	U	Left	Thru	Right	U			
All Vehicles	0	4	8	0	0	4	0	0	0	0	0	0	0	0	0	20	0	36	
Heavy Trucks	0	0	0	0	0	0	0	0	0	0	0	0	0	0	0	0	0	0	
Pedestrians		4				0					0				0			4	
Bicycles	0	0	0		0	0	0		0	0	0		0	0	0			0	
Railroad																			
Stopped Buses																			

Comments:

LOCATION: Stetson St -- Sierra St
CITY/STATE: Moss Beach, CA

QC JOB #: 14384616
DATE: Thu, Apr 20 2017

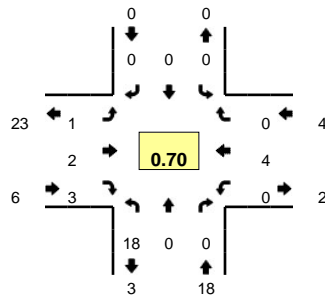

Peak-Hour: 7:45 AM -- 8:45 AM
Peak 15-Min: 8:15 AM -- 8:30 AM

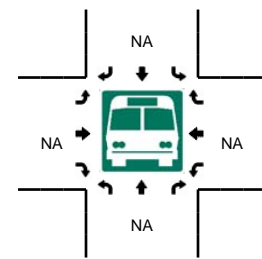
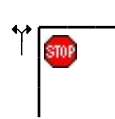
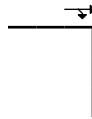
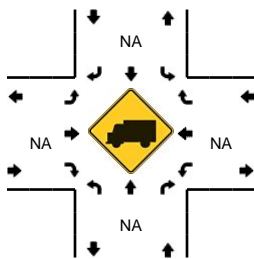
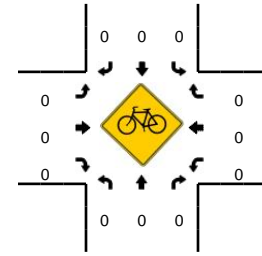
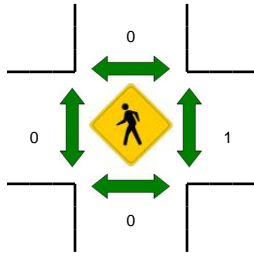
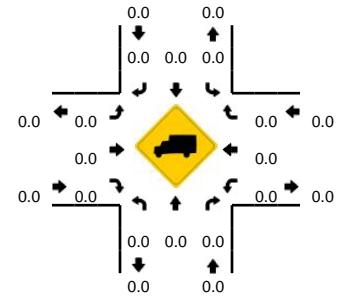

5-Min Count Period Beginning At	Stetson St (Northbound)				Stetson St (Southbound)				Sierra St (Eastbound)				Sierra St (Westbound)				Total	Hourly Totals	
	Left	Thru	Right	U	Left	Thru	Right	U	Left	Thru	Right	U	Left	Thru	Right	U			
7:00 AM	2	0	0	0	0	0	0	0	0	0	0	0	0	2	0	0	0	4	
7:05 AM	0	0	0	0	0	0	0	0	0	0	1	0	0	1	0	0	0	2	
7:10 AM	0	0	0	0	0	0	0	0	0	0	0	0	0	1	0	0	0	1	
7:15 AM	1	0	0	0	0	0	0	0	0	0	1	0	0	1	0	0	0	3	
7:20 AM	2	0	0	0	0	0	0	0	0	0	0	0	0	0	0	0	0	2	
7:25 AM	3	0	0	0	0	0	0	0	0	0	0	0	0	0	0	0	0	3	
7:30 AM	0	0	0	0	0	0	0	0	0	0	0	0	0	1	0	0	0	1	
7:35 AM	0	0	0	0	0	0	0	0	0	0	1	0	0	0	0	0	0	1	
7:40 AM	1	0	0	0	0	0	0	0	0	0	1	0	0	0	0	0	0	2	
7:45 AM	1	0	0	0	0	0	0	0	0	0	0	0	0	0	0	0	0	1	
7:50 AM	1	0	0	0	0	0	0	0	0	0	1	0	0	1	0	0	0	3	
7:55 AM	1	0	0	0	0	0	0	0	0	0	0	0	0	0	0	0	0	1	24
8:00 AM	1	0	0	0	0	0	0	0	0	0	0	0	0	0	0	0	0	1	21
8:05 AM	3	0	0	0	0	0	0	0	0	0	0	0	0	0	0	0	0	3	22
8:10 AM	1	0	0	0	0	0	0	0	0	0	0	0	0	2	0	0	0	3	24
8:15 AM	0	0	0	0	0	0	0	0	0	0	0	0	0	1	0	0	0	1	22
8:20 AM	2	0	0	0	0	0	0	0	0	0	1	0	1	0	0	0	0	4	24
8:25 AM	4	0	0	0	0	0	0	0	0	0	1	0	0	0	0	0	0	5	26
8:30 AM	1	0	0	0	0	0	0	0	0	0	0	0	0	0	0	0	0	1	26
8:35 AM	0	0	0	0	0	0	0	0	0	0	1	0	0	0	0	0	0	1	26
8:40 AM	3	0	0	0	0	0	0	0	0	0	1	0	0	0	0	0	0	4	28
8:45 AM	0	0	0	0	0	0	0	0	0	0	0	0	0	0	0	0	0	0	27
8:50 AM	0	0	0	0	0	0	0	0	0	0	0	0	0	0	0	0	0	0	24
8:55 AM	0	0	0	0	0	0	0	0	0	0	0	0	0	0	0	0	0	0	23
Peak 15-Min Flowrates	Northbound				Southbound				Eastbound				Westbound				Total		
	Left	Thru	Right	U	Left	Thru	Right	U	Left	Thru	Right	U	Left	Thru	Right	U			
All Vehicles	24	0	0	0	0	0	0	0	0	4	4	4	0	4	0	0	0	40	
Heavy Trucks	0	0	0	0	0	0	0	0	0	0	0	0	0	0	0	0	0	0	
Pedestrians	0	0	0	0	0	0	0	0	0	0	0	0	0	4	0	0	0	4	
Bicycles	0	0	0	0	0	0	0	0	0	0	0	0	0	0	0	0	0	0	
Railroad																			
Stopped Buses																			

Comments:

LOCATION: Stetson St -- Sierra St
CITY/STATE: Moss Beach, CA

QC JOB #: 14384617
DATE: Thu, Apr 20 2017

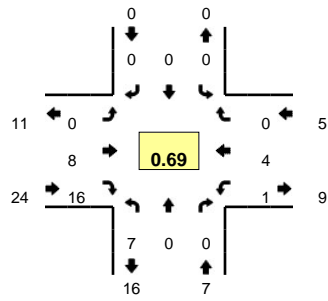

Peak-Hour: 5:00 PM -- 6:00 PM
Peak 15-Min: 5:45 PM -- 6:00 PM

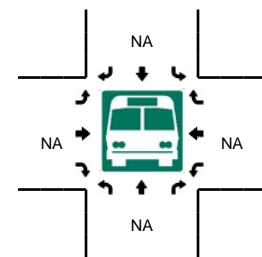
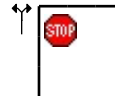
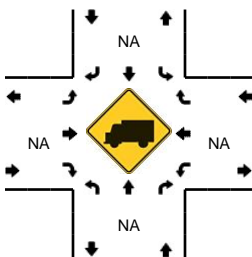
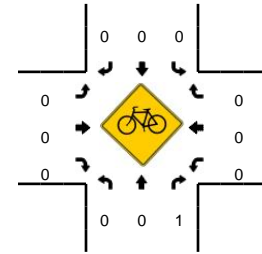
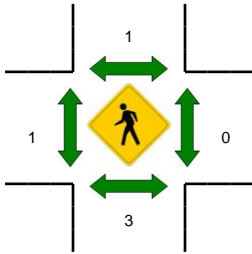
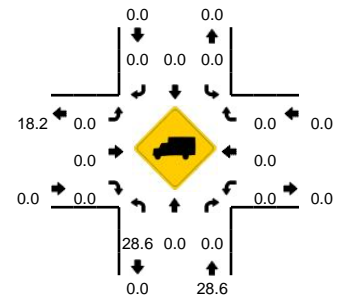

5-Min Count Period Beginning At	Stetson St (Northbound)				Stetson St (Southbound)				Sierra St (Eastbound)				Sierra St (Westbound)				Total	Hourly Totals		
	Left	Thru	Right	U	Left	Thru	Right	U	Left	Thru	Right	U	Left	Thru	Right	U				
4:00 PM	0	0	0	0	0	0	0	0	0	0	0	0	0	1	0	0	0	1		
4:05 PM	0	0	0	0	0	0	0	0	0	1	1	0	0	0	1	0	0	0	3	
4:10 PM	0	0	0	0	0	0	0	0	0	0	0	0	0	0	0	0	0	0	0	
4:15 PM	0	0	0	0	0	0	0	0	0	0	1	0	0	0	0	0	0	0	1	
4:20 PM	2	0	0	0	0	0	0	0	0	0	0	0	0	0	0	0	0	0	2	
4:25 PM	0	0	0	0	0	0	0	0	0	0	0	0	0	0	0	0	0	0	0	
4:30 PM	1	0	0	0	0	0	0	0	0	1	1	0	0	0	0	0	0	0	3	
4:35 PM	0	0	0	0	0	0	0	0	0	0	1	0	0	0	0	0	0	0	1	
4:40 PM	0	0	0	0	0	0	0	0	0	1	1	0	0	0	0	0	0	0	2	
4:45 PM	0	0	0	0	0	0	0	0	0	0	2	0	0	0	0	0	0	0	2	
4:50 PM	0	0	0	0	0	0	0	0	0	1	2	0	0	0	0	0	0	0	3	
4:55 PM	0	0	0	0	0	0	0	0	0	0	0	0	0	1	0	0	0	1	19	
5:00 PM	0	0	0	0	0	0	0	0	0	2	1	0	0	1	0	0	0	4	22	
5:05 PM	0	0	0	0	0	0	0	0	0	0	3	0	0	0	0	0	0	3	22	
5:10 PM	1	0	0	0	0	0	0	0	0	0	0	0	0	1	0	0	0	2	24	
5:15 PM	0	0	0	0	0	0	0	0	0	1	2	0	0	1	0	0	0	4	27	
5:20 PM	1	0	0	0	0	0	0	0	0	1	0	0	0	1	0	0	0	3	28	
5:25 PM	0	0	0	0	0	0	0	0	0	0	3	0	0	0	0	0	0	3	31	
5:30 PM	0	0	0	0	0	0	0	0	0	0	1	0	0	0	0	0	0	1	29	
5:35 PM	1	0	0	0	0	0	0	0	0	1	0	0	0	0	0	0	0	2	30	
5:40 PM	0	0	0	0	0	0	0	0	0	0	0	0	0	0	0	1	0	1	29	
5:45 PM	2	0	0	0	0	0	0	0	0	2	2	0	0	0	0	0	0	6	33	
5:50 PM	2	0	0	0	0	0	0	0	0	1	2	0	0	0	0	0	0	5	35	
5:55 PM	0	0	0	0	0	0	0	0	0	0	2	0	0	0	0	0	0	2	36	
Peak 15-Min Flowrates	Northbound				Southbound				Eastbound				Westbound				Total			
All Vehicles	16	0	0	0	0	0	0	0	0	12	24	0	0	0	0	0	52			
Heavy Trucks	8	0	0	0	0	0	0	0	0	0	0	0	0	0	0	0	8			
Pedestrians	0	0	0	0	0	0	0	0	0	0	0	0	0	0	0	0	0			
Bicycles	0	0	0	0	0	0	0	0	0	0	0	0	0	0	0	0	0			
Railroad																				
Stopped Buses																				

Comments:

LOCATION: Stetson St -- Sierra St
CITY/STATE: Moss Beach, CA

QC JOB #: 14384618
DATE: Sat, Apr 22 2017

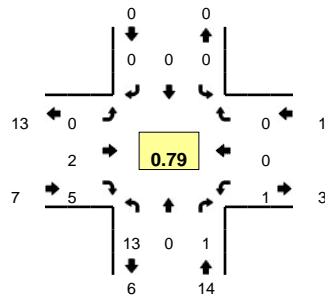

Peak-Hour: 11:40 AM -- 12:40 PM
Peak 15-Min: 11:50 AM -- 12:05 PM

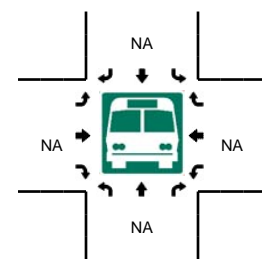
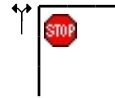
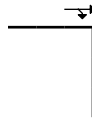
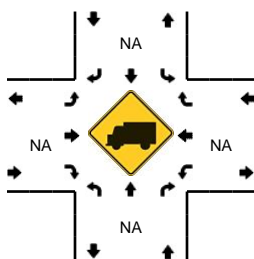
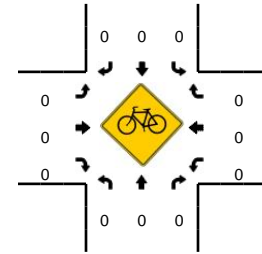
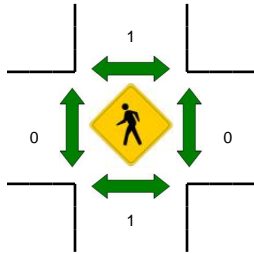
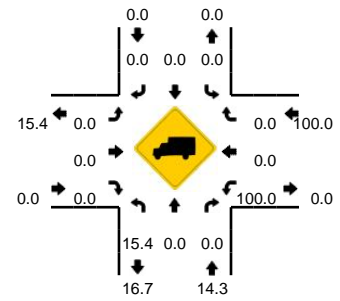

5-Min Count Period Beginning At	Stetson St (Northbound)				Stetson St (Southbound)				Sierra St (Eastbound)				Sierra St (Westbound)				Total	Hourly Totals		
	Left	Thru	Right	U	Left	Thru	Right	U	Left	Thru	Right	U	Left	Thru	Right	U				
11:00 AM	1	0	0	0	0	0	0	0	0	0	2	0	0	0	0	0	0	3		
11:05 AM	0	0	0	0	0	0	0	0	0	0	0	0	0	0	0	1	0	1		
11:10 AM	0	0	0	0	0	0	0	0	0	0	0	0	0	0	0	0	0	0		
11:15 AM	0	0	0	0	0	0	0	0	0	0	0	0	0	0	0	0	0	0		
11:20 AM	1	0	0	0	0	0	0	0	0	0	0	0	0	0	0	0	0	1		
11:25 AM	1	0	0	0	0	0	0	0	0	0	0	1	0	0	0	0	0	2		
11:30 AM	0	0	0	0	0	0	0	0	0	0	0	0	0	0	0	0	0	0		
11:35 AM	1	0	0	0	0	0	0	0	0	0	0	0	0	0	0	0	0	1		
11:40 AM	0	0	0	0	0	0	0	0	0	0	0	1	0	0	0	0	0	1		
11:45 AM	1	0	0	0	0	0	0	0	0	0	0	0	0	0	0	0	0	1		
11:50 AM	1	0	0	0	0	0	0	0	0	0	0	0	0	0	0	0	0	1		
11:55 AM	1	0	1	0	0	0	0	0	0	0	0	2	0	0	0	0	0	4	15	
12:00 PM	2	0	0	0	0	0	0	0	0	0	0	0	0	0	0	0	0	2	14	
12:05 PM	0	0	0	0	0	0	0	0	0	0	0	0	0	1	0	0	0	1	14	
12:10 PM	1	0	0	0	0	0	0	0	0	0	0	0	0	0	0	0	0	1	15	
12:15 PM	2	0	0	0	0	0	0	0	0	0	0	2	0	0	0	0	0	4	19	
12:20 PM	0	0	0	0	0	0	0	0	0	0	0	0	0	0	0	0	0	0	18	
12:25 PM	2	0	0	0	0	0	0	0	0	0	0	0	0	0	0	0	0	2	18	
12:30 PM	3	0	0	0	0	0	0	0	0	0	0	0	0	0	0	0	0	3	21	
12:35 PM	0	0	0	0	0	0	0	0	0	0	2	0	0	0	0	0	0	2	22	
12:40 PM	0	0	0	0	0	0	0	0	0	0	0	0	0	0	0	0	0	0	21	
12:45 PM	0	0	0	0	0	0	0	0	0	0	0	2	0	0	0	0	0	2	22	
12:50 PM	0	0	0	0	0	0	0	0	0	0	0	1	0	0	0	0	0	1	22	
12:55 PM	0	0	0	0	0	0	0	0	0	0	0	1	0	0	0	0	0	1	19	
Peak 15-Min Flowrates	Northbound				Southbound				Eastbound				Westbound				Total			
	Left	Thru	Right	U	Left	Thru	Right	U	Left	Thru	Right	U	Left	Thru	Right	U				
All Vehicles	16	0	4	0	0	0	0	0	0	0	0	8	0	0	0	0	0	28		
Heavy Trucks	4	0	0	0	0	0	0	0	0	0	0	0	0	0	0	0	0	4		
Pedestrians	0	0	0	0	0	0	0	0	0	0	0	0	0	0	0	0	0	0		
Bicycles	0	0	0	0	0	0	0	0	0	0	0	0	0	0	0	0	0	0		
Railroad																				
Stopped Buses																				

Comments:

LOCATION: Cabrillo Hwy (Hwy 1) -- Vallemar St/Etheldore St
CITY/STATE: San Mateo, CA

QC JOB #: 14384628
DATE: Thu, Apr 20 2017

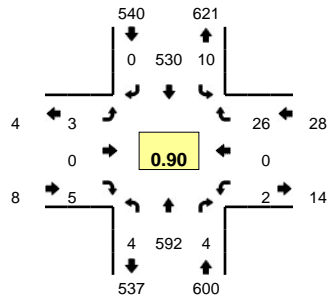

Peak-Hour: 7:45 AM -- 8:45 AM
Peak 15-Min: 8:10 AM -- 8:25 AM

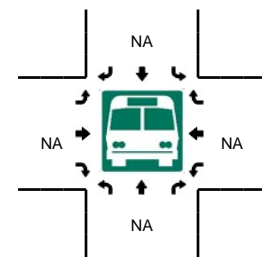
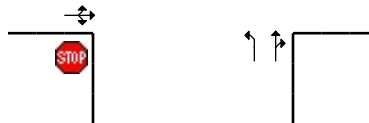
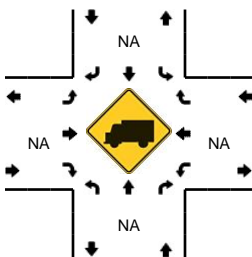
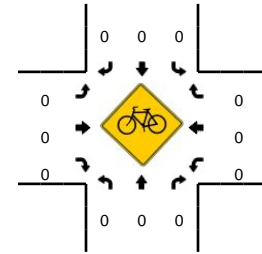
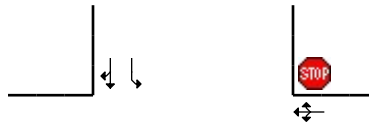
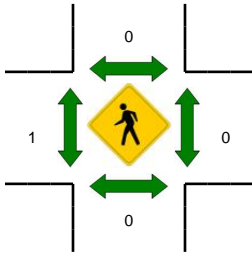
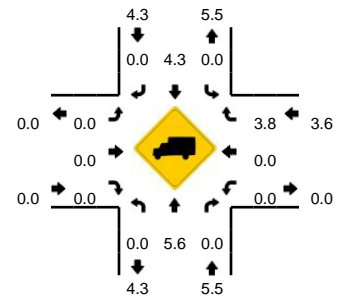

5-Min Count Period Beginning At	Cabrillo Hwy (Hwy 1) (Northbound)				Cabrillo Hwy (Hwy 1) (Southbound)				Vallemar St/Etheldore St (Eastbound)				Vallemar St/Etheldore St (Westbound)				Total	Hourly Totals
	Left	Thru	Right	U	Left	Thru	Right	U	Left	Thru	Right	U	Left	Thru	Right	U		
7:00 AM	1	49	0	0	1	21	1	0	0	0	1	0	0	0	4	0	78	
7:05 AM	0	53	0	0	0	25	0	0	0	0	1	0	0	0	2	0	81	
7:10 AM	0	44	0	0	0	30	0	0	0	0	0	0	2	0	0	0	76	
7:15 AM	0	49	1	0	1	25	0	0	0	0	0	0	0	0	5	0	81	
7:20 AM	0	55	0	0	0	29	0	0	3	0	0	0	1	0	4	0	92	
7:25 AM	0	42	0	0	0	24	0	0	0	0	1	0	0	0	2	0	69	
7:30 AM	0	50	0	0	2	27	1	0	1	0	2	0	1	0	2	0	86	
7:35 AM	0	48	0	0	0	29	0	0	0	0	1	0	0	0	3	0	81	
7:40 AM	1	52	0	0	0	43	0	0	1	0	0	0	0	0	4	0	101	
7:45 AM	0	53	2	0	0	50	0	0	2	0	0	0	0	0	2	0	109	
7:50 AM	0	51	0	0	1	47	0	0	0	0	0	0	0	0	2	0	101	
7:55 AM	0	43	1	0	1	41	0	0	0	0	1	0	0	0	2	0	89	1044
8:00 AM	0	49	0	0	0	26	0	0	0	0	0	0	0	0	1	0	76	1042
8:05 AM	0	40	0	0	1	34	0	0	0	0	1	0	0	0	0	0	76	1037
8:10 AM	1	51	0	0	2	43	0	0	0	0	0	0	1	0	4	0	102	1063
8:15 AM	1	58	0	0	2	46	0	0	0	0	0	0	0	0	5	0	112	1094
8:20 AM	1	68	0	0	2	38	0	0	1	0	0	0	0	0	3	0	113	1115
8:25 AM	0	49	1	0	0	41	0	0	0	0	1	0	1	0	1	0	94	1140
8:30 AM	0	34	0	0	1	46	0	0	0	0	0	0	0	0	1	0	82	1136
8:35 AM	0	48	0	0	0	65	0	0	0	0	2	0	0	0	1	0	116	1171
8:40 AM	1	48	0	0	0	53	0	0	0	0	0	0	0	0	4	0	106	1176
8:45 AM	0	31	0	0	1	43	0	0	1	0	1	0	0	0	1	0	78	1145
8:50 AM	0	43	0	0	1	34	1	0	0	0	0	0	0	0	1	0	80	1124
8:55 AM	0	32	0	0	0	44	0	0	0	0	1	0	0	0	3	0	80	1115
Peak 15-Min Flowrates	Northbound				Southbound				Eastbound				Westbound				Total	
	Left	Thru	Right	U	Left	Thru	Right	U	Left	Thru	Right	U	Left	Thru	Right	U		
All Vehicles	12	708	0	0	24	508	0	0	4	0	0	0	4	0	48	0	1308	
Heavy Trucks	0	40	0	0	0	12	0	0	0	0	0	0	0	0	0	0	52	
Pedestrians		0				0				0				0			0	
Bicycles	0	0	0		0	0	0		0	0	0		0	0	0		0	
Railroad																		
Stopped Buses																		

Comments:

LOCATION: Cabrillo Hwy (Hwy 1) -- Vallemar St/Etheldore St
CITY/STATE: San Mateo, CA

QC JOB #: 14384629
DATE: Thu, Apr 20 2017

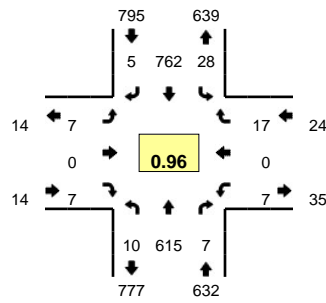

Peak-Hour: 4:45 PM -- 5:45 PM
Peak 15-Min: 4:50 PM -- 5:05 PM

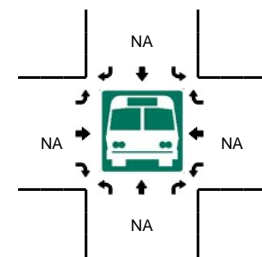
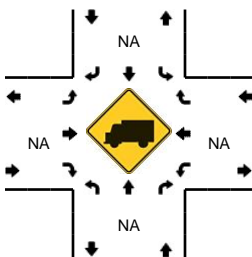
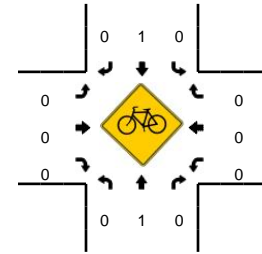
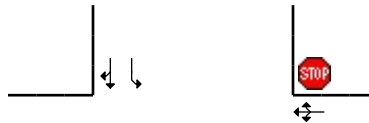
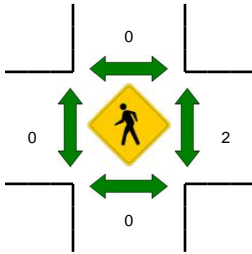
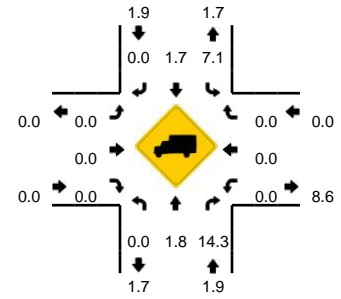

5-Min Count Period Beginning At	Cabrillo Hwy (Hwy 1) (Northbound)				Cabrillo Hwy (Hwy 1) (Southbound)				Vallemar St/Etheldore St (Eastbound)				Vallemar St/Etheldore St (Westbound)				Total	Hourly Totals
	Left	Thru	Right	U	Left	Thru	Right	U	Left	Thru	Right	U	Left	Thru	Right	U		
4:00 PM	0	20	0	0	0	30	0	0	0	0	0	0	0	0	0	0	50	
4:05 PM	1	53	0	0	3	67	0	0	0	0	0	0	0	0	1	0	125	
4:10 PM	1	50	1	0	2	53	0	0	0	0	0	0	0	2	0	0	109	
4:15 PM	0	53	1	0	2	62	0	0	0	0	0	0	0	2	0	0	120	
4:20 PM	0	56	1	0	0	54	0	0	0	0	1	0	1	0	0	0	113	
4:25 PM	0	54	2	0	4	65	1	0	0	0	0	0	0	1	0	0	127	
4:30 PM	0	50	2	0	1	45	1	0	0	0	0	0	0	1	1	0	101	
4:35 PM	0	52	0	0	1	57	1	0	0	0	0	2	0	0	1	0	114	
4:40 PM	0	44	1	0	2	66	0	0	0	0	0	0	0	0	0	0	113	
4:45 PM	2	51	0	0	4	62	0	0	0	0	1	0	1	0	2	0	123	
4:50 PM	1	47	1	0	3	56	1	0	0	0	1	0	1	0	2	0	113	
4:55 PM	2	44	1	1	4	75	0	0	1	0	0	0	1	0	2	0	131	1339
5:00 PM	1	62	0	0	0	69	0	0	0	0	1	0	0	0	6	0	139	1428
5:05 PM	0	53	2	0	1	51	1	0	0	0	0	0	0	0	0	0	108	1411
5:10 PM	0	47	1	0	2	68	0	0	0	0	1	0	0	0	0	0	119	1421
5:15 PM	1	52	0	0	5	61	0	0	2	0	1	0	1	0	1	0	124	1425
5:20 PM	1	51	0	0	1	52	1	0	2	0	0	0	1	0	1	0	110	1422
5:25 PM	0	49	0	0	4	78	1	0	0	0	1	0	1	0	1	0	135	1430
5:30 PM	1	49	0	0	2	55	0	0	0	0	0	0	0	0	0	0	107	1436
5:35 PM	0	58	2	0	1	73	0	0	1	0	1	0	1	0	1	0	138	1460
5:40 PM	0	52	0	0	1	62	1	0	1	0	0	0	0	0	1	0	118	1465
5:45 PM	0	37	1	0	3	45	0	0	0	0	0	0	0	0	2	0	88	1430
5:50 PM	0	49	0	0	4	53	0	0	1	0	0	0	0	0	2	0	109	1426
5:55 PM	0	62	0	0	2	71	0	0	0	0	0	0	0	0	0	0	135	1430
Peak 15-Min Flowrates	Northbound				Southbound				Eastbound				Westbound				Total	
	Left	Thru	Right	U	Left	Thru	Right	U	Left	Thru	Right	U	Left	Thru	Right	U		
All Vehicles	16	612	8	4	28	800	4	0	4	0	8	0	8	0	40	0	1532	
Heavy Trucks	0	24	0	0	0	12	0	0	0	0	0	0	0	0	0	0	36	
Pedestrians	0	0	0	0	0	0	0	0	0	0	0	0	0	0	0	0	0	
Bicycles	0	0	0	0	0	0	0	0	0	0	0	0	0	0	0	0	0	
Railroad																		
Stopped Buses																		

Comments:

LOCATION: Cabrillo Hwy(Hwy 1) -- Vallemar St/Etheldore St
CITY/STATE: San Mateo, CA

QC JOB #: 14384630
DATE: Sat, Apr 22 2017

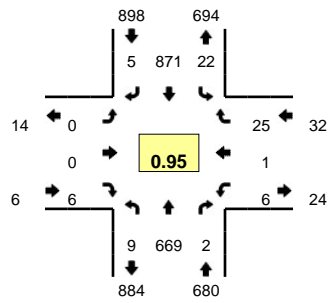

Peak-Hour: 11:55 AM -- 12:55 PM
Peak 15-Min: 12:15 PM -- 12:30 PM

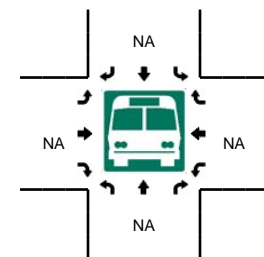
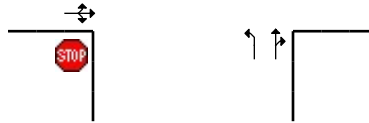
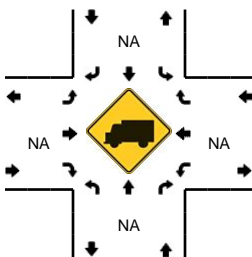
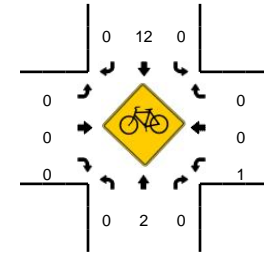
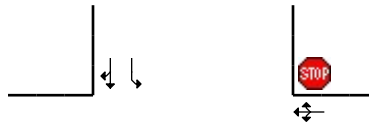
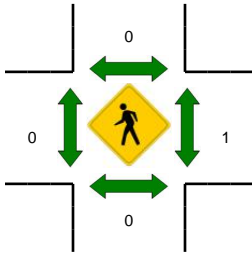
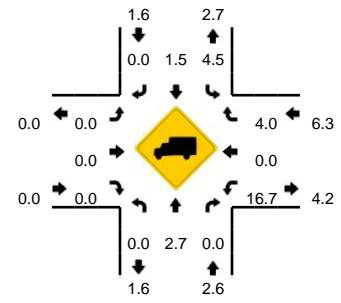

5-Min Count Period Beginning At	Cabrillo Hwy(Hwy 1) (Northbound)				Cabrillo Hwy(Hwy 1) (Southbound)				Vallemar St/Etheldore St (Eastbound)				Vallemar St/Etheldore St (Westbound)				Total	Hourly Totals
	Left	Thru	Right	U	Left	Thru	Right	U	Left	Thru	Right	U	Left	Thru	Right	U		
11:00 AM	1	50	0	0	2	58	2	0	0	0	2	0	1	1	1	0	118	
11:05 AM	0	59	0	0	0	80	0	0	0	0	0	0	2	0	3	0	144	
11:10 AM	0	51	0	0	2	73	0	0	0	0	0	0	2	0	2	0	130	
11:15 AM	0	56	1	0	0	63	0	0	0	0	1	0	1	0	3	0	125	
11:20 AM	1	47	0	0	2	83	0	0	0	0	0	0	0	0	2	0	135	
11:25 AM	1	65	0	0	2	61	0	0	2	0	0	0	1	0	3	0	135	
11:30 AM	1	38	0	0	3	77	1	0	0	0	1	0	1	0	2	0	124	
11:35 AM	0	52	0	0	1	78	0	0	0	0	0	0	0	0	0	0	131	
11:40 AM	0	39	3	0	1	74	0	0	0	0	1	0	0	0	1	0	119	
11:45 AM	0	39	0	0	2	81	0	0	0	0	0	0	0	0	5	0	127	
11:50 AM	0	39	1	0	3	69	0	0	0	1	0	0	0	0	2	0	115	
11:55 AM	0	46	0	0	3	74	0	0	0	0	0	0	1	0	2	0	126	1529
12:00 PM	1	64	0	0	2	88	0	0	0	0	0	0	1	0	2	0	158	1569
12:05 PM	1	41	0	0	2	81	0	0	0	0	0	0	1	0	2	0	128	1553
12:10 PM	1	64	0	0	3	64	0	0	0	0	1	0	0	0	2	0	135	1558
12:15 PM	0	56	1	0	1	76	1	0	0	0	0	0	0	0	2	0	137	1570
12:20 PM	2	59	0	0	1	77	0	0	0	0	1	0	1	0	3	0	144	1579
12:25 PM	1	50	0	1	2	89	0	0	0	0	1	0	0	0	0	0	144	1588
12:30 PM	0	68	0	0	0	47	0	0	0	0	0	0	0	0	2	0	117	1581
12:35 PM	0	48	0	0	1	68	0	0	0	0	0	0	0	0	2	0	119	1569
12:40 PM	0	49	0	0	2	76	3	0	0	0	0	0	1	0	2	0	133	1583
12:45 PM	2	67	0	0	0	61	0	0	0	0	2	0	1	0	2	0	135	1591
12:50 PM	0	57	1	0	5	70	1	0	0	0	1	0	0	1	4	0	140	1616
12:55 PM	0	55	0	0	0	57	0	0	0	0	1	0	0	1	0	0	114	1604
Peak 15-Min Flowrates	Northbound				Southbound				Eastbound				Westbound				Total	
	Left	Thru	Right	U	Left	Thru	Right	U	Left	Thru	Right	U	Left	Thru	Right	U		
All Vehicles	12	660	4	4	16	968	4	0	0	0	8	0	4	0	20	0	1700	
Heavy Trucks	0	24	0	0	0	16	0	0	0	0	0	0	4	0	0	0	44	
Pedestrians		0				0					0			0			0	
Bicycles	0	1	0		0	0	0		0	0	0		0	0	0		1	
Railroad																		
Stopped Buses																		

Comments:



Location: California Ave & Cabrillo Hwy

Date: 4/20/2017

Site Code: 14384625

Location:	Cabrillo Hwy (Hwy 1) Southbound					California Ave Westbound					Cabrillo Hwy (Hwy 1) Northbound					California Ave Eastbound					Wienke Way Southeastbound				
	Right to Wienke Way	Right	Thru	Left	U-Turn	Right	Thru to Wienke Way	Thru	Left	U-Turn	Right	Thru	Left to Wienke Way	Left	U-Turn	Right	Thru	Left	Left to Wienke Way	U-Turn	Right to California Ave	Right to Cabrillo Hwy (Hwy 1)	Thru to California Ave	Left to Cabrillo Hwy (Hwy 1)	U-Turn
7:00 AM	0	0	23	0	0	3	0	0	2	0	0	49	0	0	0	0	0	0	0	0	0	0	0	0	0
7:05 AM	0	0	26	0	0	4	0	0	2	0	0	47	0	0	0	0	0	1	0	0	0	1	0	0	0
7:10 AM	0	0	32	0	0	1	0	0	5	0	1	42	1	0	0	2	0	0	0	0	0	0	0	1	0
7:15 AM	0	0	26	0	0	0	0	0	3	0	0	49	0	0	0	0	0	0	0	0	0	3	0	0	0
7:20 AM	0	0	26	0	0	1	0	0	3	0	0	55	0	1	0	0	0	0	0	0	0	0	0	0	0
7:25 AM	0	0	28	0	0	1	0	0	5	0	0	43	0	0	1	0	0	0	0	0	0	1	0	0	0
7:30 AM	0	0	29	0	0	1	0	0	8	0	3	46	0	0	0	1	0	2	0	0	0	2	0	0	0
7:35 AM	0	0	31	1	0	1	0	0	3	0	1	47	1	0	0	0	0	0	0	0	0	0	0	0	0
7:40 AM	0	0	43	0	0	4	0	0	6	0	0	50	1	1	0	0	0	0	0	0	0	0	1	0	0
7:45 AM	0	0	45	2	0	0	0	0	6	0	2	52	1	0	0	0	0	0	0	0	0	1	0	0	0
7:50 AM	0	0	45	1	0	1	0	0	4	0	1	54	0	0	0	1	0	0	0	0	0	1	0	0	0
7:55 AM	0	1	42	0	0	2	0	0	3	0	2	41	1	0	0	0	1	0	0	0	0	2	0	0	0
8:00 AM	0	0	28	0	0	1	0	0	4	0	1	48	1	0	0	1	0	0	0	0	0	0	0	0	0
8:05 AM	0	0	34	0	0	0	0	0	3	0	1	35	1	0	0	1	0	2	0	0	0	0	0	1	0
8:10 AM	0	0	43	0	0	1	0	0	6	0	4	50	0	1	0	2	0	1	0	0	0	0	0	0	0
8:15 AM	0	0	45	1	0	2	0	0	4	0	1	59	0	0	0	1	0	0	0	0	1	0	0	0	0
8:20 AM	0	0	34	0	0	1	0	0	1	0	0	67	2	1	0	1	0	2	0	0	0	1	0	0	0
8:25 AM	0	1	45	1	0	2	0	0	5	0	1	45	1	0	0	1	0	1	0	0	0	0	0	1	0
8:30 AM	0	0	46	0	0	2	0	0	3	0	1	32	0	0	0	0	0	0	0	0	0	0	0	1	0
8:35 AM	0	0	60	1	0	2	0	0	4	0	3	46	0	2	0	2	0	2	0	0	0	0	0	0	0
8:40 AM	0	3	54	0	0	1	0	0	5	0	4	45	0	0	0	1	0	1	0	0	0	0	0	0	0
8:45 AM	0	0	44	0	0	0	0	0	4	0	1	33	1	1	0	2	0	0	0	0	0	2	0	0	0
8:50 AM	0	1	35	1	0	1	0	0	4	0	0	40	2	1	0	2	0	0	0	0	0	0	0	2	0
8:55 AM	0	0	42	2	0	1	0	0	5	0	2	31	0	0	0	1	0	0	0	0	0	0	0	0	0
Total	0	6	906	10	0	33	0	0	98	0	29	1106	13	8	0	20	0	13	0	0	1	14	1	6	0

Peak Hour: 7:45 AM - 8:45 AM

Peak 15: 8:30 AM - 8:45 AM

PHF: 0.929348



Location: California Ave & Cabrillo Hwy

Date: 4/20/2017

Site Code: 14384625

Location:	Cabrillo Hwy (Hwy 1) Southbound					California Ave Westbound					Cabrillo Hwy (Hwy 1) Northbound					California Ave Eastbound					Wienke Way Southeastbound				
	Right to Wienke Way	Right	Thru	Left	U-Turn	Right	Thru to Wienke Way	Thru	Left	U-Turn	Right	Thru	Left to Wienke Way	Left	U-Turn	Right	Thru	Left	Left to Wienke Way	U-Turn	Right to California Ave	Right to Cabrillo Hwy (Hwy 1)	Thru to California Ave	Left to Cabrillo Hwy (Hwy 1)	U-Turn
7:00 AM	0	0	20	0	0	3	0	0	2	0	0	47	0	0	0	0	0	0	0	0	0	0	0	0	0
7:05 AM	0	0	24	0	0	4	0	0	2	0	0	45	0	0	0	0	0	1	0	0	0	0	1	0	0
7:10 AM	0	0	32	0	0	1	0	0	5	0	1	39	1	0	0	2	0	0	0	0	0	0	0	1	0
7:15 AM	0	0	24	0	0	0	0	0	3	0	0	49	0	0	0	0	0	0	0	0	0	0	3	0	0
7:20 AM	0	0	25	0	0	1	0	0	3	0	0	51	0	1	0	0	0	0	0	0	0	0	0	0	0
7:25 AM	0	0	27	0	0	1	0	0	5	0	0	42	0	0	0	1	0	0	0	0	0	0	1	0	0
7:30 AM	0	0	28	0	0	1	0	0	8	0	3	45	0	0	0	1	0	2	0	0	0	0	2	0	0
7:35 AM	0	0	30	1	0	1	0	0	3	0	1	42	1	0	0	0	0	0	0	0	0	0	0	0	0
7:40 AM	0	0	43	0	0	3	0	0	6	0	0	49	1	1	0	0	0	0	0	0	0	0	1	0	0
7:45 AM	0	0	43	2	0	0	0	0	6	0	2	46	1	0	0	0	0	0	0	0	0	0	1	0	0
7:50 AM	0	0	45	1	0	1	0	0	4	0	1	47	0	0	0	1	0	0	0	0	0	0	1	0	0
7:55 AM	0	1	41	0	0	2	0	0	3	0	2	37	1	0	0	0	0	1	0	0	0	0	2	0	0
8:00 AM	0	0	28	0	0	1	0	0	4	0	1	45	1	0	0	1	0	0	0	0	0	0	0	0	0
8:05 AM	0	0	34	0	0	0	0	0	3	0	1	30	1	0	0	1	0	2	0	0	0	0	0	1	0
8:10 AM	0	0	43	0	0	1	0	0	6	0	4	45	0	1	0	2	0	1	0	0	0	0	0	0	0
8:15 AM	0	0	43	1	0	2	0	0	4	0	1	56	0	0	0	1	0	0	0	0	0	1	0	0	0
8:20 AM	0	0	34	0	0	1	0	0	1	0	0	61	2	1	0	1	0	2	0	0	0	0	1	0	0
8:25 AM	0	1	40	1	0	2	0	0	5	0	1	42	1	0	0	1	0	1	0	0	0	0	0	1	0
8:30 AM	0	0	40	0	0	2	0	0	3	0	1	31	0	0	0	0	0	0	0	0	0	0	0	1	0
8:35 AM	0	0	57	1	0	2	0	0	4	0	3	45	0	2	0	2	0	2	0	0	0	0	0	0	0
8:40 AM	0	3	52	0	0	1	0	0	5	0	4	43	0	0	0	1	0	1	0	0	0	0	0	0	0
8:45 AM	0	0	42	0	0	0	0	0	4	0	1	31	1	1	0	2	0	0	0	0	0	2	0	0	0
8:50 AM	0	1	32	1	0	1	0	0	4	0	0	40	2	1	0	2	0	0	0	0	0	0	0	2	0
8:55 AM	0	0	41	2	0	1	0	0	5	0	2	29	0	0	0	1	0	0	0	0	0	0	0	0	0
Total	0	6	868	10	0	32	0	0	98	0	29	1037	13	8	0	20	0	13	0	0	1	14	1	6	0



Location: California Ave & Cabrillo Hwy

Date: 4/20/2017

Site Code: 14384625

Location:	Cabrillo Hwy (Hwy 1) Southbound					California Ave Westbound					Cabrillo Hwy (Hwy 1) Northbound					California Ave Eastbound					Wienke Way Southeastbound				
	Right to Wienke Way	Right	Thru	Left	Peds	Right	Thru to Wienke Way	Thru	Left	Peds	Right	Thru	Left to Wienke Way	Left	Peds	Right	Thru	Left	Left to Wienke Way	Peds	Right to California Ave	Right to Cabrillo Hwy (Hwy 1)	Thru to California Ave	Left to Cabrillo Hwy (Hwy 1)	Peds
7:00 AM	0	0	0	0	0	0	0	0	0	0	0	0	0	0	0	0	0	0	0	0	0	0	0	0	0
7:05 AM	0	0	0	0	0	0	0	0	0	0	0	0	0	0	0	0	0	0	1	0	0	0	0	0	0
7:10 AM	0	0	0	0	0	0	0	0	0	0	0	0	0	0	0	2	0	0	0	0	0	0	0	0	0
7:15 AM	0	0	0	0	0	0	0	0	0	0	0	0	0	0	1	0	0	0	0	0	0	0	0	0	0
7:20 AM	0	0	0	0	0	0	0	0	0	0	0	0	0	0	0	0	0	0	0	0	0	0	0	0	0
7:25 AM	0	0	0	0	0	0	0	0	0	0	0	0	0	0	0	1	0	0	0	0	0	0	0	0	0
7:30 AM	0	0	0	0	0	0	0	0	0	0	0	0	0	0	0	1	0	2	0	0	0	0	0	0	0
7:35 AM	0	0	0	0	0	0	0	0	0	0	0	0	0	0	0	0	0	0	0	0	0	0	0	0	0
7:40 AM	0	0	0	0	0	0	0	0	0	0	0	0	0	0	0	0	0	0	0	0	0	0	0	0	0
7:45 AM	0	0	0	0	0	0	0	0	0	0	0	0	0	0	0	0	0	0	0	0	0	0	0	0	0
7:50 AM	0	0	0	0	0	0	0	0	0	0	0	0	0	0	0	1	0	0	0	0	0	0	0	0	0
7:55 AM	0	0	0	0	0	0	0	0	0	0	0	0	0	0	0	0	0	1	0	1	0	1	0	0	1
8:00 AM	0	0	0	0	0	0	0	0	0	0	0	0	0	0	0	1	0	0	0	0	0	0	0	0	0
8:05 AM	0	0	0	0	0	0	0	0	0	0	0	0	0	0	0	1	0	2	0	0	0	0	0	0	0
8:10 AM	0	0	0	0	0	0	0	0	0	0	0	0	0	0	0	2	0	1	0	0	0	0	0	0	0
8:15 AM	0	0	0	0	0	0	0	0	0	0	0	0	0	0	0	1	0	0	0	0	0	0	0	0	0
8:20 AM	0	0	0	0	0	0	0	0	0	0	0	0	0	0	0	1	0	2	0	0	0	0	0	0	0
8:25 AM	0	0	0	0	0	0	0	0	0	0	0	0	0	0	0	1	0	1	0	0	0	0	0	0	0
8:30 AM	0	0	0	0	0	0	0	0	0	0	0	0	0	0	0	0	0	0	0	0	0	0	0	0	0
8:35 AM	0	0	0	0	0	0	0	0	0	0	0	0	0	0	0	2	0	2	0	0	0	0	0	0	0
8:40 AM	0	0	0	0	0	0	0	0	0	0	0	0	0	0	0	1	0	1	0	0	0	0	0	0	0
8:45 AM	0	0	0	0	0	0	0	0	0	0	0	0	0	0	0	2	0	0	0	0	0	0	0	0	0
8:50 AM	0	0	1	0	0	0	0	0	0	0	0	0	0	0	0	2	0	0	0	0	0	0	0	0	0
8:55 AM	0	0	0	0	1	0	0	0	0	0	0	0	0	0	0	1	0	0	0	0	0	0	0	0	0
Total	0	0	1	0	1	0	0	0	0	0	0	0	0	0	1	20	0	13	0	1	0	0	0	0	1



Location: California Ave & Cabrillo Hwy

Date: 4/20/2017

Site Code: 14384626

Location:	Cabrillo Hwy (Hwy 1) Southbound					California Ave Westbound					Cabrillo Hwy (Hwy 1) Northbound					California Ave Eastbound					Wienke Way Southeastbound				
	Right to Wienke Way	Right	Thru	Left	U-Turn	Right	Thru to Wienke Way	Thru	Left	U-Turn	Right	Thru	Left to Wienke Way	Left	U-Turn	Right	Thru	Left	Left to Wienke Way	U-Turn	Right to California Ave	Right to Cabrillo Hwy (Hwy 1)	Thru to California Ave	Left to Cabrillo Hwy (Hwy 1)	U-Turn
4:00 PM	0	0	68	4	0	1	0	0	4	0	5	51	1	1	0	0	0	3	0	0	0	0	0	0	0
4:05 PM	0	0	64	0	0	0	0	0	1	0	3	53	3	0	0	0	0	0	0	0	0	0	0	0	0
4:10 PM	0	0	52	1	0	3	0	0	2	0	5	51	0	1	0	0	0	0	0	0	0	0	0	0	0
4:15 PM	1	0	57	2	0	0	0	0	1	0	3	54	0	1	0	4	1	0	0	0	0	0	0	0	0
4:20 PM	0	1	56	1	0	1	0	0	2	0	4	55	1	3	0	1	0	1	0	0	1	1	0	0	0
4:25 PM	1	0	61	0	0	3	0	0	4	0	1	53	0	3	0	0	0	1	0	0	0	0	0	0	0
4:30 PM	0	1	47	1	0	1	0	0	3	0	5	49	1	1	0	1	0	1	0	0	0	2	0	2	0
4:35 PM	0	0	57	1	0	0	0	0	3	0	3	53	0	1	0	0	0	0	0	0	0	1	0	0	0
4:40 PM	0	0	63	0	0	1	0	0	1	0	3	44	1	0	0	0	0	0	0	0	0	1	0	0	0
4:45 PM	0	1	63	1	0	2	0	0	3	0	4	48	1	1	0	0	0	0	0	0	0	0	0	0	0
4:50 PM	0	2	60	3	0	1	0	0	6	0	4	47	0	0	0	0	0	0	0	0	0	0	0	1	0
4:55 PM	1	0	62	3	0	1	0	0	0	0	8	45	0	0	0	0	0	1	0	0	1	0	0	0	0
5:00 PM	0	0	68	2	0	1	0	0	1	0	1	60	1	0	0	0	0	0	0	0	0	0	0	0	0
5:05 PM	0	0	55	1	0	2	0	0	2	0	2	54	0	0	0	1	0	0	0	0	0	0	0	0	0
5:10 PM	0	0	71	0	0	0	0	0	2	0	1	46	2	0	0	0	0	0	0	0	0	0	0	0	0
5:15 PM	0	1	58	2	0	2	0	0	4	0	4	53	0	2	0	1	0	0	0	0	0	0	0	0	0
5:20 PM	0	3	52	1	0	3	0	0	5	0	4	48	0	0	0	0	0	0	0	0	0	0	0	0	0
5:25 PM	0	0	72	2	0	0	0	0	3	0	1	50	0	1	0	1	0	0	0	0	0	0	0	0	0
5:30 PM	0	0	59	0	0	0	1	0	1	0	3	48	1	1	0	0	0	1	0	0	0	0	0	0	0
5:35 PM	0	2	77	2	0	0	0	0	0	0	1	62	1	0	0	0	0	0	0	0	0	1	0	0	0
5:40 PM	0	1	59	0	0	0	0	0	5	0	9	51	1	0	0	0	0	1	0	0	0	0	0	0	0
5:45 PM	0	0	45	0	0	0	0	1	2	0	9	37	1	0	0	0	0	2	0	0	1	1	0	0	0
5:50 PM	0	0	50	0	0	0	0	0	4	0	3	48	0	0	0	0	0	0	0	0	0	0	0	0	0
5:55 PM	0	0	69	0	0	1	0	0	2	0	3	59	1	0	0	0	0	0	0	0	1	1	0	0	0
Total	3	12	1445	27	0	23	1	1	61	0	89	1219	16	16	0	9	1	11	0	0	4	8	0	3	0

Peak Hour: 4:45 PM - 5:45 PM

Peak 15: 5:30 PM - 5:45 PM

PHF: 0.907609



Location: California Ave & Cabrillo Hwy

Date: 4/20/2017

Site Code: 14384626

Location:	Cabrillo Hwy (Hwy 1) Southbound					California Ave Westbound					Cabrillo Hwy (Hwy 1) Northbound					California Ave Eastbound					Wienke Way Southeastbound				
	Right to Wienke Way	Right	Thru	Left	U-Turn	Right	Thru to Wienke Way	Thru	Left	U-Turn	Right	Thru	Left to Wienke Way	Left	U-Turn	Right	Thru	Left	Left to Wienke Way	U-Turn	Right to California Ave	Right to Cabrillo Hwy (Hwy 1)	Thru to California Ave	Left to Cabrillo Hwy (Hwy 1)	U-Turn
4:00 PM	0	0	67	4	0	1	0	0	4	0	5	50	1	1	0	0	0	3	0	0	0	0	0	0	0
4:05 PM	0	0	61	0	0	0	0	0	1	0	3	51	3	0	0	0	0	0	0	0	0	0	0	0	0
4:10 PM	0	0	49	1	0	3	0	0	2	0	5	50	0	1	0	0	0	0	0	0	0	0	0	0	0
4:15 PM	1	0	57	2	0	0	0	0	1	0	3	53	0	1	0	4	1	0	0	0	0	0	0	0	0
4:20 PM	0	1	53	1	0	1	0	0	2	0	4	52	1	3	0	1	0	1	0	0	0	1	0	0	0
4:25 PM	1	0	61	0	0	3	0	0	4	0	1	52	0	3	0	0	0	1	0	0	0	0	0	0	0
4:30 PM	0	1	45	1	0	1	0	0	3	0	5	49	1	1	0	1	0	1	0	0	0	2	0	2	0
4:35 PM	0	0	53	1	0	0	0	0	3	0	3	52	0	1	0	0	0	0	0	0	0	1	0	0	0
4:40 PM	0	0	62	0	0	1	0	0	1	0	3	41	1	0	0	0	0	0	0	0	0	1	0	0	0
4:45 PM	0	1	61	1	0	2	0	0	3	0	4	47	1	1	0	0	0	0	0	0	0	0	0	0	0
4:50 PM	0	2	58	3	0	1	0	0	6	0	4	44	0	0	0	0	0	0	0	0	0	0	0	1	0
4:55 PM	1	0	62	3	0	1	0	0	0	0	7	45	0	0	0	0	1	0	0	0	1	0	0	0	0
5:00 PM	0	0	65	2	0	1	0	0	1	0	1	57	1	0	0	0	0	0	0	0	0	0	0	0	0
5:05 PM	0	0	55	1	0	2	0	0	2	0	2	52	0	0	0	1	0	0	0	0	0	0	0	0	0
5:10 PM	0	0	70	0	0	0	0	0	2	0	1	45	2	0	0	0	0	0	0	0	0	0	0	0	0
5:15 PM	0	1	58	2	0	2	0	0	4	0	4	53	0	2	0	1	0	0	0	0	0	0	0	0	0
5:20 PM	0	3	51	1	0	3	0	0	5	0	4	47	0	0	0	0	0	0	0	0	0	0	0	0	0
5:25 PM	0	0	70	2	0	0	0	0	2	0	1	49	0	1	0	1	0	0	0	0	0	0	0	0	0
5:30 PM	0	0	58	0	0	0	1	0	0	0	3	48	1	1	0	0	0	1	0	0	0	0	0	0	0
5:35 PM	0	2	76	2	0	0	0	0	0	0	1	62	1	0	0	0	0	0	0	0	0	1	0	0	0
5:40 PM	0	1	57	0	0	0	0	0	5	0	9	51	1	0	0	0	0	0	0	0	0	0	0	0	0
5:45 PM	0	0	45	0	0	0	0	1	2	0	9	36	1	0	0	0	0	2	0	0	1	1	0	0	0
5:50 PM	0	0	50	0	0	0	0	0	4	0	3	47	0	0	0	0	0	0	0	0	0	0	0	0	0
5:55 PM	0	0	69	0	0	1	0	0	2	0	3	59	1	0	0	0	0	0	0	0	1	1	0	0	0
Total	3	12	1413	27	0	23	1	1	59	0	88	1192	16	16	0	9	1	10	0	0	3	8	0	3	0



Location: California Ave & Cabrillo Hwy

Date: 4/20/2017

Site Code: 14384626

Location:	Cabrillo Hwy (Hwy 1) Southbound				California Ave Westbound				Cabrillo Hwy (Hwy 1) Northbound				California Ave Eastbound				Wienke Way Southeastbound			
	Right to Wienke Way	Right	Thru	Left	Right	Thru to Wienke Way	Thru	Left	Right	Thru	Left to Wienke Way	Left	Right	Thru	Left	Left to Wienke Way	Right to California Ave	Right to Cabrillo Hwy (Hwy 1)	Thru to California Ave	Left to Cabrillo Hwy (Hwy 1)
4:00 PM	0	0	1	0	0	0	0	0	0	1	0	0	0	0	0	0	0	0	0	0
4:05 PM	0	0	3	0	0	0	0	0	0	2	0	0	0	0	0	0	0	0	0	0
4:10 PM	0	0	3	0	0	0	0	0	0	1	0	0	0	0	0	0	0	0	0	0
4:15 PM	0	0	0	0	0	0	0	0	0	1	0	0	0	0	0	0	0	0	0	0
4:20 PM	0	0	3	0	0	0	0	0	0	3	0	0	0	0	0	0	1	0	0	0
4:25 PM	0	0	0	0	0	0	0	0	0	1	0	0	0	0	0	0	0	0	0	0
4:30 PM	0	0	2	0	0	0	0	0	0	0	0	0	0	0	0	0	0	0	0	0
4:35 PM	0	0	4	0	0	0	0	0	0	1	0	0	0	0	0	0	0	0	0	0
4:40 PM	0	0	1	0	0	0	0	0	0	3	0	0	0	0	0	0	0	0	0	0
4:45 PM	0	0	2	0	0	0	0	0	0	1	0	0	0	0	0	0	0	0	0	0
4:50 PM	0	0	2	0	0	0	0	0	0	3	0	0	0	0	0	0	0	0	0	0
4:55 PM	0	0	0	0	0	0	0	0	1	0	0	0	0	0	0	0	0	0	0	0
5:00 PM	0	0	3	0	0	0	0	0	0	3	0	0	0	0	0	0	0	0	0	0
5:05 PM	0	0	0	0	0	0	0	0	0	2	0	0	0	0	0	0	0	0	0	0
5:10 PM	0	0	1	0	0	0	0	0	0	1	0	0	0	0	0	0	0	0	0	0
5:15 PM	0	0	0	0	0	0	0	0	0	0	0	0	0	0	0	0	0	0	0	0
5:20 PM	0	0	1	0	0	0	0	1	0	1	0	0	0	0	0	0	0	0	0	0
5:25 PM	0	0	2	0	0	0	0	1	0	1	0	0	0	0	0	0	0	0	0	0
5:30 PM	0	0	1	0	0	0	0	1	0	0	0	0	0	0	0	0	0	0	0	0
5:35 PM	0	0	1	0	0	0	0	0	0	0	0	0	0	0	0	0	0	0	0	0
5:40 PM	0	0	2	0	0	0	0	0	0	0	0	0	0	0	1	0	0	0	0	0
5:45 PM	0	0	0	0	0	0	0	0	0	1	0	0	0	0	0	0	0	0	0	0
5:50 PM	0	0	0	0	0	0	0	0	0	1	0	0	0	0	0	0	0	0	0	0
5:55 PM	0	0	0	0	0	0	0	0	0	0	0	0	0	0	0	0	0	0	0	0
Total	0	0	32	0	0	0	0	2	1	27	0	0	0	0	0	1	0	0	0	0



Location: California Ave & Cabrillo Hwy

Date: 4/20/2017

Site Code: 14384626

Location:	Cabrillo Hwy (Hwy 1) Southbound					California Ave Westbound					Cabrillo Hwy (Hwy 1) Northbound					California Ave Eastbound					Wienke Way Southeastbound				
	Right to Wienke Way	Right	Thru	Left	Peds	Right	Thru to Wienke Way	Thru	Left	Peds	Right	Thru	Left to Wienke Way	Left	Peds	Right	Thru	Left	Left to Wienke Way	Peds	Right to California Ave	Right to Cabrillo Hwy (Hwy 1)	Thru to California Ave	Left to Cabrillo Hwy (Hwy 1)	Peds
4:00 PM	0	0	0	0	1	0	0	0	0	0	0	0	0	0	0	0	0	0	0	0	0	0	0	0	0
4:05 PM	0	0	0	0	0	0	0	0	0	0	0	0	0	0	0	0	0	0	0	0	0	0	0	0	0
4:10 PM	0	0	0	0	1	0	0	0	0	0	0	0	0	0	1	0	0	0	0	0	0	0	0	0	0
4:15 PM	0	0	0	0	0	0	0	0	0	0	0	0	0	0	0	0	0	0	0	0	1	0	0	0	0
4:20 PM	0	0	0	0	0	0	0	0	0	0	0	0	0	0	0	0	0	0	0	0	0	0	0	0	0
4:25 PM	0	0	0	0	0	0	0	0	0	0	0	0	0	0	0	0	0	0	0	0	0	0	0	0	0
4:30 PM	0	0	0	0	0	0	0	0	0	0	0	0	0	0	1	0	0	0	0	0	0	0	0	0	0
4:35 PM	0	0	0	0	0	0	0	0	0	0	0	0	0	0	0	0	0	0	0	0	0	0	0	0	0
4:40 PM	0	0	0	0	0	0	0	0	0	0	0	0	0	0	0	0	0	0	0	0	0	0	0	0	0
4:45 PM	0	0	0	0	1	0	0	0	0	0	0	0	0	0	0	0	0	0	0	0	0	0	0	0	0
4:50 PM	0	0	0	0	0	0	0	0	0	0	0	0	0	0	0	0	0	0	0	0	0	0	0	0	0
4:55 PM	0	0	0	0	0	0	0	0	0	0	0	0	0	0	0	0	0	0	0	0	0	0	0	0	0
5:00 PM	0	0	0	0	0	0	0	0	0	0	0	0	0	0	0	0	0	0	0	0	0	0	0	0	0
5:05 PM	0	0	0	0	0	0	0	0	0	0	0	0	0	0	0	0	0	0	0	0	0	0	0	0	0
5:10 PM	0	0	0	0	0	0	0	0	0	0	0	0	0	0	0	0	0	0	0	0	1	0	0	0	0
5:15 PM	0	0	0	0	0	0	0	0	0	0	0	0	0	0	0	0	0	0	0	0	0	0	0	0	0
5:20 PM	0	0	0	0	0	0	0	0	0	0	0	0	0	0	0	0	0	0	0	0	0	0	0	0	0
5:25 PM	0	0	0	0	0	0	0	0	0	0	0	0	0	0	0	0	0	0	0	0	0	0	0	0	0
5:30 PM	0	0	0	0	0	0	0	0	0	0	0	0	0	0	0	0	0	0	0	0	0	0	0	0	0
5:35 PM	0	0	0	0	0	0	0	0	0	0	0	0	0	0	0	0	0	0	0	0	0	0	0	0	0
5:40 PM	0	0	0	0	0	0	0	0	0	0	0	0	0	0	0	0	0	0	0	0	0	0	0	0	0
5:45 PM	0	0	0	0	0	0	0	0	0	0	0	1	0	0	0	0	0	0	0	0	3	0	0	0	0
5:50 PM	0	0	0	0	0	0	0	0	0	0	0	1	0	0	0	0	0	0	0	0	0	0	0	0	0
5:55 PM	0	0	0	0	0	0	0	0	0	0	0	0	0	0	0	0	0	0	0	0	0	0	0	0	0
Total	0	0	0	0	3	0	0	0	0	0	0	2	0	0	2	0	0	0	0	5	0	0	0	0	0



Location: California Ave & Cabrillo Hwy

Date: 4/22/2017

Site Code: 14384627

Location:	Cabrillo Hwy (Hwy 1) Southbound					California Ave Westbound					Cabrillo Hwy (Hwy 1) Northbound					California Ave Eastbound					Wienke Way Southeastbound				
	Right to Wienke Way	Right	Thru	Left	U-Turn	Right	Thru to Wienke Way	Thru	Left	U-Turn	Right	Thru	Left to Wienke Way	Left	U-Turn	Right	Thru	Left	Left to Wienke Way	U-Turn	Right to California Ave	Right to Cabrillo Hwy (Hwy 1)	Thru to California Ave	Left to Cabrillo Hwy (Hwy 1)	U-Turn
11:00 AM	1	0	66	0	0	1	0	1	1	0	2	49	1	1	0	1	0	1	0	0	1	0	0	0	0
11:05 AM	1	2	76	1	0	1	0	1	3	0	3	53	0	2	0	0	1	0	0	0	1	2	0	0	0
11:10 AM	0	0	74	1	0	4	0	0	3	0	3	47	0	0	0	1	0	1	0	0	0	0	0	0	0
11:15 AM	0	0	64	1	0	1	0	0	0	0	6	58	0	4	0	2	1	1	0	0	0	0	1	0	0
11:20 AM	0	0	83	1	0	1	0	0	1	0	3	46	1	1	0	1	0	1	0	0	0	1	0	0	0
11:25 AM	1	0	59	0	0	1	0	0	2	0	4	64	0	2	0	0	2	0	0	0	0	1	0	0	0
11:30 AM	0	1	79	1	0	3	0	0	1	0	4	31	1	1	0	2	0	0	0	0	0	1	0	0	0
11:35 AM	1	0	75	0	0	1	0	0	6	0	5	52	0	0	0	2	0	1	0	0	1	2	0	0	0
11:40 AM	0	0	75	1	0	0	0	0	4	0	9	40	1	2	0	2	0	1	1	0	0	1	0	0	0
11:45 AM	0	0	79	0	0	1	0	0	3	0	4	38	0	0	0	2	0	0	0	0	0	1	0	0	0
11:50 AM	0	0	70	1	0	0	0	0	0	0	4	40	0	1	0	0	0	0	0	0	0	1	0	0	0
11:55 AM	0	1	73	1	0	2	1	1	2	0	2	48	1	1	0	0	0	0	0	0	0	0	0	0	0
12:00 PM	0	0	87	0	0	5	0	0	1	0	3	54	0	0	0	4	0	1	0	0	0	2	0	1	0
12:05 PM	1	0	82	1	0	2	0	0	3	0	4	40	0	0	0	0	0	0	0	0	0	0	0	0	0
12:10 PM	1	1	67	0	0	1	0	1	1	0	1	63	0	4	0	2	0	1	0	0	0	2	0	0	0
12:15 PM	0	1	70	1	0	2	0	0	2	0	0	57	0	4	1	2	0	0	0	0	0	0	0	0	0
12:20 PM	0	0	76	0	0	0	0	0	1	0	3	61	0	3	0	3	0	0	1	0	0	0	0	0	0
12:25 PM	1	1	91	1	0	1	0	0	4	0	4	51	0	3	0	1	0	0	0	0	0	0	0	0	0
12:30 PM	0	0	51	0	0	1	0	0	1	0	2	65	1	3	0	1	0	1	0	0	0	1	0	0	0
12:35 PM	0	0	69	0	0	1	0	0	1	0	5	46	0	3	0	1	2	1	0	0	0	0	1	0	0
12:40 PM	0	1	69	0	0	2	0	1	5	0	4	47	0	3	0	3	0	0	0	0	0	2	0	2	0
12:45 PM	0	1	65	1	0	5	0	0	1	0	5	62	0	4	1	1	1	0	0	0	0	0	0	0	0
12:50 PM	2	1	64	1	0	0	0	0	1	0	3	58	0	0	0	3	0	1	0	0	0	0	0	0	0
12:55 PM	0	0	61	1	0	1	0	0	0	0	2	53	1	0	0	0	0	0	0	0	0	1	0	0	0
Total	9	10	1725	14	0	37	1	5	47	0	85	1223	7	42	2	34	5	13	2	0	3	18	2	3	0

Peak Hour: 11:55 AM - 12:55 PM

Peak 15: 12:40 PM - 12:55 PM

PHF: 0.952381



Location: California Ave & Cabrillo Hwy

Date: 4/22/2017

Site Code: 14384627

Location:	Cabrillo Hwy (Hwy 1) Southbound					California Ave Westbound					Cabrillo Hwy (Hwy 1) Northbound					California Ave Eastbound					Wienke Way Southeastbound				
	Right to Wienke Way	Right	Thru	Left	U-Turn	Right	Thru to Wienke Way	Thru	Left	U-Turn	Right	Thru	Left to Wienke Way	Left	U-Turn	Right	Thru	Left	Left to Wienke Way	U-Turn	Right to California Ave	Right to Cabrillo Hwy (Hwy 1)	Thru to California Ave	Left to Cabrillo Hwy (Hwy 1)	U-Turn
11:00 AM	1	0	64	0	0	1	0	1	1	0	2	49	1	1	0	1	0	1	0	0	1	0	0	0	0
11:05 AM	0	2	76	1	0	1	0	1	3	0	3	53	0	2	0	0	0	1	0	0	0	0	2	0	0
11:10 AM	0	0	72	1	0	4	0	0	3	0	3	45	0	0	0	1	0	1	0	0	0	0	0	0	0
11:15 AM	0	0	63	1	0	1	0	0	0	0	6	57	0	4	0	2	1	1	0	0	0	0	1	0	0
11:20 AM	0	0	82	1	0	1	0	0	1	0	3	45	1	1	0	1	0	1	0	0	0	1	0	0	0
11:25 AM	1	0	59	0	0	1	0	0	2	0	4	63	0	2	0	0	0	2	0	0	0	1	0	0	0
11:30 AM	0	1	77	1	0	3	0	0	1	0	4	31	1	1	0	2	0	0	0	0	0	1	0	0	0
11:35 AM	1	0	72	0	0	1	0	0	6	0	5	51	0	0	0	2	0	1	0	0	1	2	0	0	0
11:40 AM	0	0	75	1	0	0	0	0	4	0	9	40	1	2	0	2	0	1	1	0	0	1	0	0	0
11:45 AM	0	0	79	0	0	1	0	0	3	0	4	37	0	0	0	2	0	0	0	0	0	1	0	0	0
11:50 AM	0	0	66	1	0	0	0	0	0	0	4	39	0	1	0	0	0	0	0	0	0	1	0	0	0
11:55 AM	0	1	73	1	0	2	1	1	2	0	2	47	1	1	0	0	0	0	0	0	0	0	0	0	0
12:00 PM	0	0	87	0	0	5	0	0	1	0	3	54	0	0	0	4	0	1	0	0	0	2	0	1	0
12:05 PM	1	0	82	1	0	2	0	0	3	0	4	40	0	0	0	0	0	0	0	0	0	0	0	0	0
12:10 PM	1	1	66	0	0	1	0	1	1	0	1	63	0	4	0	2	0	1	0	0	0	2	0	0	0
12:15 PM	0	1	69	1	0	2	0	0	2	0	0	57	0	4	1	2	0	0	0	0	0	0	0	0	0
12:20 PM	0	0	74	0	0	0	0	0	1	0	3	60	0	3	0	3	0	0	1	0	0	0	0	0	0
12:25 PM	1	1	89	1	0	1	0	0	4	0	4	48	0	3	0	1	0	0	0	0	0	0	0	0	0
12:30 PM	0	0	48	0	0	1	0	0	1	0	2	63	1	3	0	1	0	1	0	0	0	1	0	0	0
12:35 PM	0	0	65	0	0	1	0	0	1	0	5	45	0	3	0	1	2	1	0	0	0	0	1	0	0
12:40 PM	0	1	68	0	0	2	0	1	5	0	4	45	0	3	0	3	0	0	0	0	0	2	0	2	0
12:45 PM	0	1	64	1	0	5	0	0	1	0	5	59	0	4	1	1	1	0	0	0	0	0	0	0	0
12:50 PM	2	1	64	1	0	0	0	0	1	0	3	57	0	0	0	3	0	1	0	0	0	0	0	0	0
12:55 PM	0	0	57	1	0	1	0	0	0	0	2	53	1	0	0	0	0	0	0	0	0	1	0	0	0
Total	8	10	1691	14	0	37	1	5	47	0	85	1201	7	42	2	34	5	13	2	0	2	18	2	3	0



Location: California Ave & Cabrillo Hwy

Date: 4/22/2017

Site Code: 14384627

Location:	Cabrillo Hwy (Hwy 1) Southbound				California Ave Westbound				Cabrillo Hwy (Hwy 1) Northbound				California Ave Eastbound				Wienke Way Southeastbound			
	Right to Wienke Way	Right	Thru	Left	Right	Thru to Wienke Way	Thru	Left	Right	Thru	Left to Wienke Way	Left	Right	Thru	Left	Left to Wienke Way	Right to California Ave	Right to Cabrillo Hwy (Hwy 1)	Thru to California Ave	Left to Cabrillo Hwy (Hwy 1)
11:00 AM	0	0	2	0	0	0	0	0	0	0	0	0	0	0	0	0	0	0	0	0
11:05 AM	1	0	0	0	0	0	0	0	0	0	0	0	0	0	0	0	0	1	0	0
11:10 AM	0	0	2	0	0	0	0	0	0	0	2	0	0	0	0	0	0	0	0	0
11:15 AM	0	0	1	0	0	0	0	0	0	0	1	0	0	0	0	0	0	0	0	0
11:20 AM	0	0	1	0	0	0	0	0	0	0	1	0	0	0	0	0	0	0	0	0
11:25 AM	0	0	0	0	0	0	0	0	0	0	1	0	0	0	0	0	0	0	0	0
11:30 AM	0	0	2	0	0	0	0	0	0	0	0	0	0	0	0	0	0	0	0	0
11:35 AM	0	0	3	0	0	0	0	0	0	0	1	0	0	0	0	0	0	0	0	0
11:40 AM	0	0	0	0	0	0	0	0	0	0	0	0	0	0	0	0	0	0	0	0
11:45 AM	0	0	0	0	0	0	0	0	0	0	1	0	0	0	0	0	0	0	0	0
11:50 AM	0	0	4	0	0	0	0	0	0	0	1	0	0	0	0	0	0	0	0	0
11:55 AM	0	0	0	0	0	0	0	0	0	0	1	0	0	0	0	0	0	0	0	0
12:00 PM	0	0	0	0	0	0	0	0	0	0	0	0	0	0	0	0	0	0	0	0
12:05 PM	0	0	0	0	0	0	0	0	0	0	0	0	0	0	0	0	0	0	0	0
12:10 PM	0	0	1	0	0	0	0	0	0	0	0	0	0	0	0	0	0	0	0	0
12:15 PM	0	0	1	0	0	0	0	0	0	0	0	0	0	0	0	0	0	0	0	0
12:20 PM	0	0	2	0	0	0	0	2	0	0	1	0	0	0	0	0	0	0	0	0
12:25 PM	0	0	2	0	0	0	0	0	0	0	3	0	0	0	0	0	0	0	0	0
12:30 PM	0	0	3	0	0	0	0	0	0	0	2	0	0	0	0	0	0	0	0	0
12:35 PM	0	0	4	0	0	0	0	0	0	0	1	0	0	0	0	0	0	0	0	0
12:40 PM	0	0	1	0	0	0	0	1	0	0	2	0	0	0	0	0	0	0	0	0
12:45 PM	0	0	1	0	0	0	0	0	0	0	3	0	0	0	0	0	0	0	0	0
12:50 PM	0	0	0	0	0	0	0	0	0	0	1	0	0	0	0	0	0	0	0	0
12:55 PM	0	0	4	0	0	0	0	0	0	0	0	0	0	0	0	0	0	0	0	0
Total	1	0	34	0	0	0	0	0	0	0	22	0	0	0	0	0	1	0	0	0

LOCATION: Carlos St -- California Ave
CITY/STATE: San Mateo, CA

QC JOB #: 14384622
DATE: Thu, Apr 20 2017

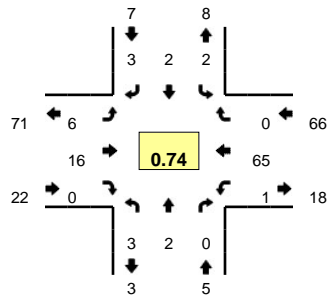

Peak-Hour: 7:25 AM -- 8:25 AM
Peak 15-Min: 7:30 AM -- 7:45 AM

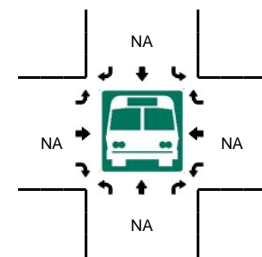
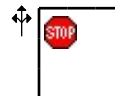
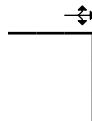
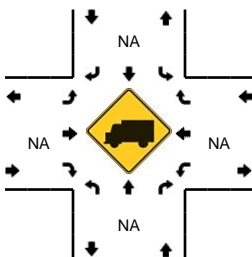
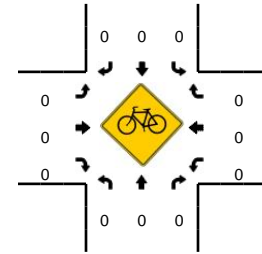
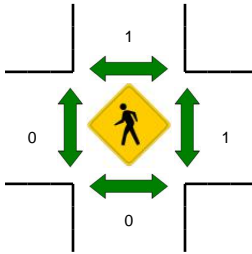
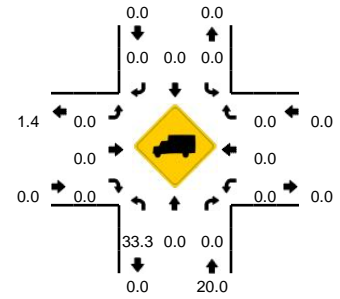

5-Min Count Period Beginning At	Carlos St (Northbound)				Carlos St (Southbound)				California Ave (Eastbound)				California Ave (Westbound)				Total	Hourly Totals
	Left	Thru	Right	U	Left	Thru	Right	U	Left	Thru	Right	U	Left	Thru	Right	U		
7:00 AM	0	0	0	0	0	0	0	0	0	0	0	0	0	2	0	0	2	
7:05 AM	0	0	0	0	0	0	0	0	0	0	0	0	0	7	0	0	7	
7:10 AM	0	0	0	0	0	0	0	0	1	0	0	0	1	5	0	0	7	
7:15 AM	0	1	0	0	0	0	0	0	0	0	0	0	0	3	0	0	4	
7:20 AM	0	0	0	0	0	0	0	0	0	0	0	0	0	4	0	0	4	
7:25 AM	0	0	0	0	0	0	0	0	1	0	0	0	0	6	0	0	7	
7:30 AM	0	0	0	0	1	0	0	0	1	2	0	0	0	9	0	0	13	
7:35 AM	0	1	0	0	0	0	0	0	0	1	0	0	0	5	0	0	7	
7:40 AM	2	0	0	0	0	0	0	0	0	2	0	0	0	10	0	0	14	
7:45 AM	0	0	0	0	1	0	0	0	0	2	0	0	0	5	0	0	8	
7:50 AM	0	0	0	0	0	0	1	0	1	1	0	0	0	3	0	0	6	
7:55 AM	0	1	0	0	0	0	0	0	1	1	0	0	0	4	0	0	7	86
8:00 AM	0	0	0	0	0	0	1	0	0	1	0	0	0	5	0	0	7	91
8:05 AM	0	0	0	0	0	0	1	0	1	1	0	0	0	5	0	0	8	92
8:10 AM	0	0	0	0	0	0	0	0	0	3	0	0	1	6	0	0	10	95
8:15 AM	1	0	0	0	0	1	0	0	1	1	0	0	0	2	0	0	6	97
8:20 AM	0	0	0	0	0	1	0	0	0	1	0	0	0	5	0	0	7	100
8:25 AM	0	0	0	0	0	0	0	0	0	1	0	0	0	5	0	0	6	99
8:30 AM	0	0	0	0	0	0	0	0	1	1	0	0	0	5	0	0	7	93
8:35 AM	0	1	0	0	0	0	2	0	2	4	0	0	0	5	0	0	14	100
8:40 AM	0	0	0	0	0	0	1	0	1	0	0	0	0	5	0	0	7	93
8:45 AM	0	0	0	0	0	0	0	0	0	1	0	0	0	2	1	0	4	89
8:50 AM	0	0	0	0	0	0	2	0	0	1	0	0	0	5	0	0	8	91
8:55 AM	0	1	0	0	0	0	1	0	2	4	0	0	0	5	1	0	14	98
Peak 15-Min Flowrates	Northbound				Southbound				Eastbound				Westbound				Total	
	Left	Thru	Right	U	Left	Thru	Right	U	Left	Thru	Right	U	Left	Thru	Right	U		
All Vehicles	8	4	0	0	4	0	0	0	4	20	0	0	0	96	0	0	136	
Heavy Trucks	4	0	0	0	0	0	0	0	0	0	0	0	0	0	0	0	4	
Pedestrians	0	0	0	0	0	0	0	0	0	0	0	0	0	0	0	0	0	
Bicycles	0	0	0	0	0	0	0	0	0	0	0	0	0	0	0	0	0	
Railroad																		
Stopped Buses																		

Comments:

LOCATION: Carlos St -- California Ave
CITY/STATE: San Mateo, CA

QC JOB #: 14384623
DATE: Thu, Apr 20 2017

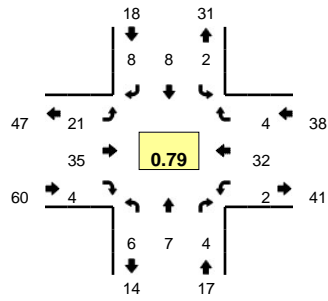

Peak-Hour: 4:00 PM -- 5:00 PM
Peak 15-Min: 4:45 PM -- 5:00 PM

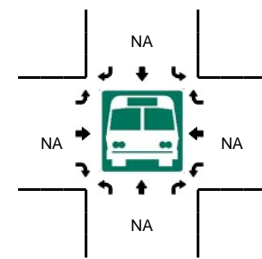
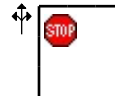
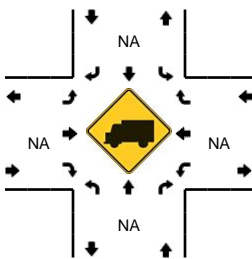
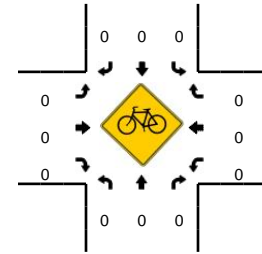
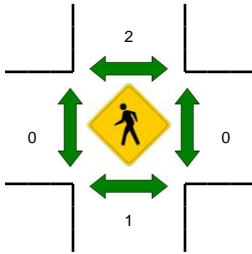
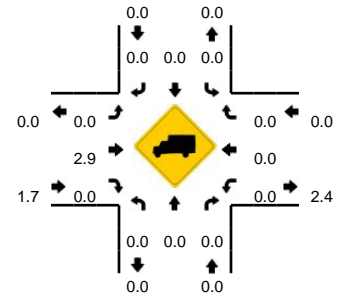

5-Min Count Period Beginning At	Carlos St (Northbound)				Carlos St (Southbound)				California Ave (Eastbound)				California Ave (Westbound)				Total	Hourly Totals	
	Left	Thru	Right	U	Left	Thru	Right	U	Left	Thru	Right	U	Left	Thru	Right	U			
4:00 PM	1	0	0	0	0	1	0	0	0	0	5	1	0	1	4	0	0	13	
4:05 PM	0	0	0	0	1	0	1	0	4	1	0	0	1	0	0	0	8		
4:10 PM	1	0	1	0	0	0	0	0	3	1	0	0	0	4	0	0	10		
4:15 PM	0	1	1	0	0	2	0	0	3	3	1	0	0	1	0	0	12		
4:20 PM	0	0	0	0	0	0	0	0	1	3	0	0	0	2	0	0	6		
4:25 PM	0	1	0	0	1	0	3	0	0	1	0	0	0	0	4	0	10		
4:30 PM	0	2	1	0	0	2	1	0	2	3	1	0	0	4	1	0	17		
4:35 PM	0	0	0	0	0	0	0	0	1	2	0	0	0	2	0	0	5		
4:40 PM	2	0	0	0	0	1	0	0	1	2	0	0	0	2	2	0	10		
4:45 PM	2	1	0	0	0	0	0	0	0	6	1	1	0	4	0	0	15		
4:50 PM	0	2	1	0	0	0	2	0	1	2	0	0	0	3	0	0	11		
4:55 PM	0	0	0	0	0	2	1	0	4	6	0	0	0	2	1	0	16	133	
5:00 PM	2	0	0	0	1	2	0	0	0	1	0	0	0	0	1	0	7	127	
5:05 PM	0	0	2	0	0	0	1	0	0	4	0	0	0	2	0	0	9	128	
5:10 PM	0	1	0	0	0	0	0	0	1	0	0	0	0	3	0	0	5	123	
5:15 PM	0	0	1	0	1	1	2	0	1	5	0	0	0	4	0	0	15	126	
5:20 PM	3	0	1	0	0	0	2	0	1	3	0	0	0	3	0	0	13	133	
5:25 PM	1	0	0	0	1	0	0	0	0	3	0	0	1	1	0	0	7	130	
5:30 PM	0	0	1	0	0	1	1	0	2	1	0	0	0	0	0	0	6	119	
5:35 PM	0	0	0	0	0	0	1	0	2	3	0	0	0	0	0	0	6	120	
5:40 PM	0	1	0	0	0	0	0	0	4	6	0	0	0	4	0	0	15	125	
5:45 PM	0	0	0	0	1	1	1	0	0	7	0	0	0	2	1	0	13	123	
5:50 PM	0	0	0	0	0	1	1	0	0	1	0	0	0	4	0	0	7	119	
5:55 PM	1	0	1	0	0	1	1	0	2	3	0	0	0	0	0	0	9	112	
Peak 15-Min Flowrates	Northbound				Southbound				Eastbound				Westbound				Total		
	Left	Thru	Right	U	Left	Thru	Right	U	Left	Thru	Right	U	Left	Thru	Right	U			
All Vehicles	8	12	4	0	0	8	12	0	20	56	4	4	0	36	4	0	168		
Heavy Trucks	0	0	0	0	0	0	0	0	0	4	0	0	0	0	0	0	4		
Pedestrians		4				0				0				0			4		
Bicycles	0	0	0		0	0	0		0	0	0		0	0	0		0		
Railroad																			
Stopped Buses																			

Comments:

LOCATION: Carlos St -- California Ave
CITY/STATE: San Mateo, CA

QC JOB #: 14384624
DATE: Sat, Apr 22 2017

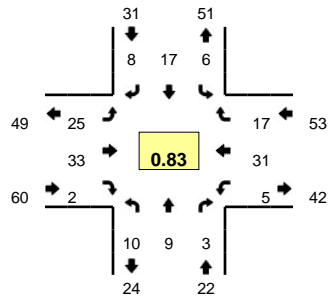

Peak-Hour: 11:10 AM -- 12:10 PM
Peak 15-Min: 11:35 AM -- 11:50 AM

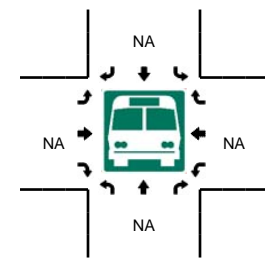
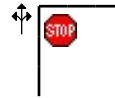
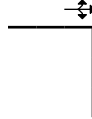
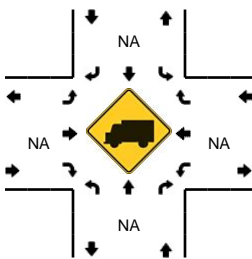
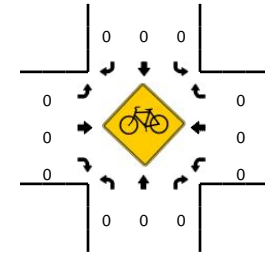
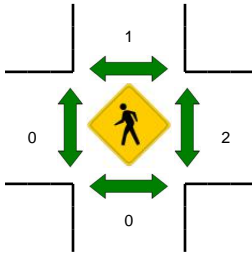
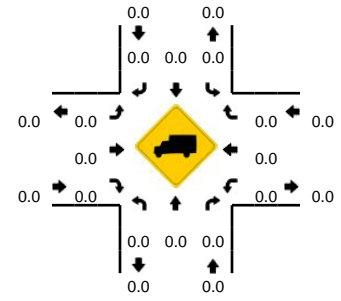

5-Min Count Period Beginning At	Carlos St (Northbound)				Carlos St (Southbound)				California Ave (Eastbound)				California Ave (Westbound)				Total	Hourly Totals
	Left	Thru	Right	U	Left	Thru	Right	U	Left	Thru	Right	U	Left	Thru	Right	U		
11:00 AM	0	0	0	0	1	0	3	0	1	2	0	0	0	2	0	0	9	
11:05 AM	2	1	0	0	0	1	1	0	0	3	0	0	0	1	1	0	10	
11:10 AM	1	0	0	0	0	0	0	0	3	4	0	0	0	5	4	0	17	
11:15 AM	1	0	0	0	0	3	0	0	3	2	0	0	0	0	0	0	9	
11:20 AM	0	3	0	0	0	1	0	0	0	4	0	0	0	3	1	0	12	
11:25 AM	0	0	0	0	1	1	1	0	2	2	0	0	0	1	1	0	9	
11:30 AM	3	1	0	0	0	1	2	0	3	4	0	0	0	1	1	0	16	
11:35 AM	1	0	0	0	0	1	1	0	4	4	0	0	0	4	1	0	16	
11:40 AM	0	2	0	0	1	1	2	0	2	3	0	0	1	3	1	0	16	
11:45 AM	0	1	2	0	0	3	0	0	3	3	0	0	1	1	4	0	18	
11:50 AM	0	1	0	0	2	3	0	0	0	2	1	0	0	1	2	0	12	
11:55 AM	1	0	0	0	1	0	1	0	2	0	1	0	0	3	1	0	10	154
12:00 PM	3	1	1	0	1	2	1	0	1	2	0	0	2	4	1	0	19	164
12:05 PM	0	0	0	0	0	1	0	0	2	3	0	0	1	5	0	0	12	166
12:10 PM	0	0	1	0	0	0	1	0	0	1	0	0	0	1	0	1	5	154
12:15 PM	0	2	1	0	0	0	1	0	1	1	0	0	0	3	0	0	9	154
12:20 PM	1	0	0	0	0	0	0	0	2	4	0	0	0	2	0	0	9	151
12:25 PM	0	1	0	0	0	1	0	0	0	2	0	0	0	2	0	0	6	148
12:30 PM	1	0	0	0	0	0	0	0	0	2	0	0	1	2	0	0	6	138
12:35 PM	1	1	1	0	1	0	0	0	5	3	1	0	0	2	0	0	15	137
12:40 PM	0	1	1	0	1	0	1	0	1	2	0	0	0	8	0	0	15	136
12:45 PM	2	0	0	0	1	0	1	0	1	5	1	0	0	0	0	0	11	129
12:50 PM	0	0	0	0	0	0	0	0	3	0	1	0	0	1	0	0	5	122
12:55 PM	0	0	0	0	0	0	1	0	1	1	0	0	0	0	1	0	4	116
Peak 15-Min Flowrates	Northbound				Southbound				Eastbound				Westbound				Total	
	Left	Thru	Right	U	Left	Thru	Right	U	Left	Thru	Right	U	Left	Thru	Right	U		
All Vehicles	4	12	8	0	4	20	12	0	36	40	0	0	8	32	24	0	200	
Heavy Trucks	0	0	0	0	0	0	0	0	0	0	0	0	0	0	0	0	0	
Pedestrians	0	0	0	0	0	4	0	0	0	0	0	0	0	4	0	0	8	
Bicycles	0	0	0	0	0	0	0	0	0	0	0	0	0	0	0	0	0	
Railroad																		
Stopped Buses																		

Comments:

LOCATION: Etheldore St -- California Ave
CITY/STATE: Moss Beach, CA

QC JOB #: 14384610
DATE: Thu, Apr 20 2017

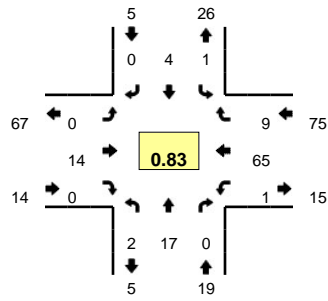

Peak-Hour: 7:15 AM -- 8:15 AM
Peak 15-Min: 7:30 AM -- 7:45 AM

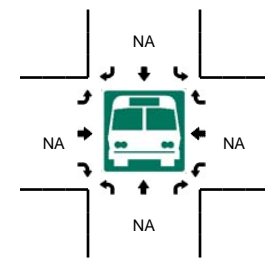
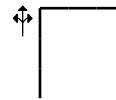
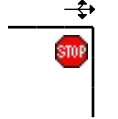
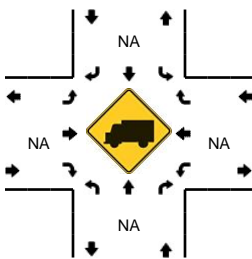
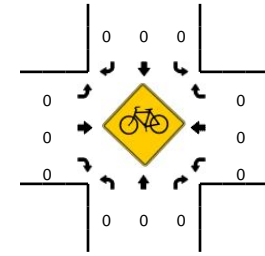
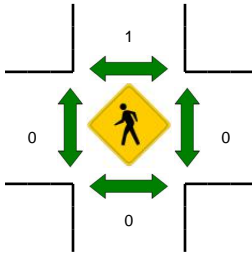
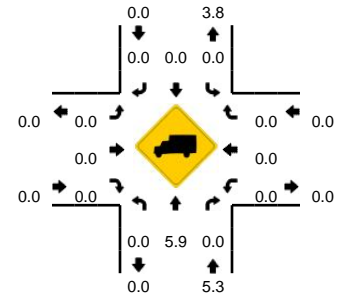

5-Min Count Period Beginning At	Etheldore St (Northbound)				Etheldore St (Southbound)				California Ave (Eastbound)				California Ave (Westbound)				Total	Hourly Totals
	Left	Thru	Right	U	Left	Thru	Right	U	Left	Thru	Right	U	Left	Thru	Right	U		
7:00 AM	0	1	0	0	0	1	1	0	0	0	0	0	0	2	2	0	7	
7:05 AM	1	1	0	0	0	0	0	0	0	0	0	0	0	5	0	0	7	
7:10 AM	0	0	0	0	0	0	0	0	0	0	0	0	0	6	0	0	6	
7:15 AM	0	4	0	0	0	1	0	0	0	0	0	0	0	3	2	0	10	
7:20 AM	0	1	0	0	0	0	0	0	0	0	0	0	0	4	1	0	6	
7:25 AM	1	2	0	0	0	0	0	0	0	0	0	0	0	8	1	0	12	
7:30 AM	0	1	0	0	0	0	0	0	0	3	0	0	0	6	1	0	11	
7:35 AM	0	2	0	0	0	0	0	0	0	1	0	0	0	5	0	0	8	
7:40 AM	0	2	0	0	0	0	0	0	0	2	0	0	0	10	1	0	15	
7:45 AM	0	1	0	0	0	1	0	0	0	2	0	0	0	5	1	0	10	
7:50 AM	0	0	0	0	1	1	0	0	0	0	0	0	0	3	1	0	6	
7:55 AM	0	0	0	0	0	0	0	0	0	1	0	0	0	4	1	0	6	104
8:00 AM	0	0	0	0	0	0	0	0	0	1	0	0	0	5	0	0	6	103
8:05 AM	0	1	0	0	0	0	0	0	0	1	0	0	0	5	0	0	7	103
8:10 AM	1	3	0	0	0	1	0	0	0	3	0	0	1	7	0	0	16	113
8:15 AM	0	1	0	0	0	1	0	0	0	0	1	0	0	1	2	0	6	109
8:20 AM	1	1	0	0	1	0	0	0	0	1	0	0	0	6	0	0	10	113
8:25 AM	0	0	0	0	0	0	0	0	0	0	0	0	0	4	0	0	4	105
8:30 AM	0	1	0	0	1	0	0	0	0	1	0	0	1	6	0	0	10	104
8:35 AM	0	3	0	0	0	0	1	0	0	4	0	0	0	3	1	0	12	108
8:40 AM	2	1	0	0	0	0	1	0	0	0	0	0	0	2	0	0	6	99
8:45 AM	0	1	0	0	0	0	0	0	0	0	0	0	0	3	0	0	4	93
8:50 AM	0	2	1	0	0	0	0	0	0	1	0	0	0	7	0	0	11	98
8:55 AM	0	1	0	0	0	0	0	0	0	2	0	0	0	4	0	0	7	99
Peak 15-Min Flowrates	Northbound				Southbound				Eastbound				Westbound				Total	
	Left	Thru	Right	U	Left	Thru	Right	U	Left	Thru	Right	U	Left	Thru	Right	U		
All Vehicles	0	20	0	0	0	0	0	0	0	24	0	0	0	84	8	0	136	
Heavy Trucks	0	4	0	0	0	0	0	0	0	0	0	0	0	0	0	0	4	
Pedestrians	0	0	0	0	0	0	0	0	0	0	0	0	0	0	0	0	0	
Bicycles	0	0	0	0	0	0	0	0	0	0	0	0	0	0	0	0	0	
Railroad																		
Stopped Buses																		

Comments:

LOCATION: Etheldore St -- California Ave
CITY/STATE: Moss Beach, CA

QC JOB #: 14384611
DATE: Thu, Apr 20 2017

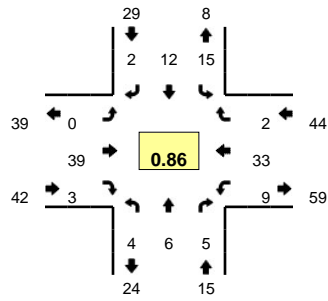

Peak-Hour: 4:25 PM -- 5:25 PM
Peak 15-Min: 5:10 PM -- 5:25 PM

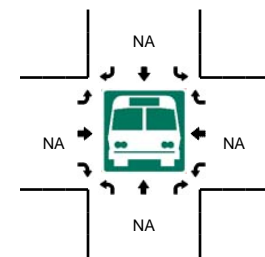
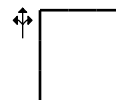
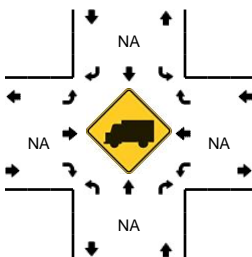
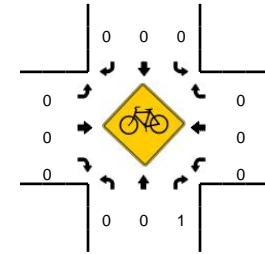
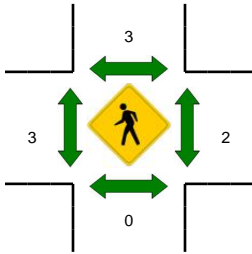
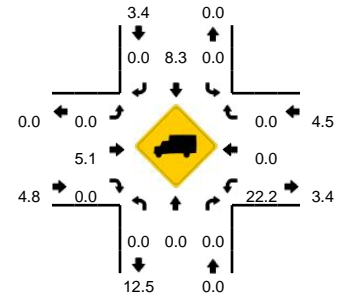

5-Min Count Period Beginning At	Etheldore St (Northbound)				Etheldore St (Southbound)				California Ave (Eastbound)				California Ave (Westbound)				Total	Hourly Totals	
	Left	Thru	Right	U	Left	Thru	Right	U	Left	Thru	Right	U	Left	Thru	Right	U			
4:00 PM	0	0	1	0	1	0	0	0	0	5	0	0	0	0	4	0	0	11	
4:05 PM	0	1	1	0	0	1	0	0	0	2	0	0	0	0	1	0	0	6	
4:10 PM	1	0	1	0	1	1	0	0	1	2	0	0	1	3	0	0	11		
4:15 PM	0	1	0	0	1	3	0	0	0	4	0	0	0	1	0	0	10		
4:20 PM	1	1	0	0	0	0	0	0	0	2	1	0	0	1	0	0	6		
4:25 PM	0	1	0	0	0	3	0	0	0	2	0	0	1	4	0	0	11		
4:30 PM	0	0	0	0	0	1	0	0	0	2	1	0	1	7	0	0	12		
4:35 PM	0	0	1	0	1	2	0	0	0	2	0	0	1	0	0	0	7		
4:40 PM	2	0	0	0	1	0	0	0	0	2	0	0	0	3	0	0	8		
4:45 PM	1	0	1	0	3	1	1	0	0	5	0	0	0	2	0	0	14		
4:50 PM	0	1	0	0	0	2	0	0	0	3	0	0	0	3	0	0	9		
4:55 PM	1	0	0	0	1	0	0	0	0	6	0	0	0	2	0	0	10	115	
5:00 PM	0	2	1	0	1	1	0	0	0	2	0	0	0	1	2	0	10	114	
5:05 PM	0	0	1	0	1	1	0	0	0	6	1	0	0	1	0	0	11	119	
5:10 PM	0	0	0	0	3	0	1	0	0	0	0	0	0	4	0	0	8	116	
5:15 PM	0	0	0	0	2	0	0	0	0	5	1	0	3	2	0	0	13	119	
5:20 PM	0	2	1	0	2	1	0	0	0	4	0	0	3	4	0	0	17	130	
5:25 PM	0	0	2	0	0	1	0	0	0	4	0	0	1	1	0	0	9	128	
5:30 PM	0	0	1	0	1	0	0	0	0	1	0	0	0	0	0	0	3	119	
5:35 PM	0	1	0	0	1	2	0	0	0	1	0	0	0	0	0	0	5	117	
5:40 PM	0	0	0	0	1	0	0	0	0	6	0	0	0	3	0	0	10	119	
5:45 PM	1	2	0	0	1	1	0	0	0	5	1	0	1	2	0	0	14	119	
5:50 PM	0	0	0	0	0	1	0	0	0	2	0	0	1	4	0	0	8	118	
5:55 PM	0	0	0	0	1	1	0	0	0	3	1	0	0	0	0	0	6	114	
Peak 15-Min Flowrates	Northbound				Southbound				Eastbound				Westbound				Total		
	Left	Thru	Right	U	Left	Thru	Right	U	Left	Thru	Right	U	Left	Thru	Right	U			
All Vehicles	0	8	4	0	28	4	4	0	0	36	4	0	24	40	0	0	152		
Heavy Trucks	0	0	0		0	0	0		0	4	0		8	0	0		12		
Pedestrians	0				0					12			0				12		
Bicycles	0	0	1		0	0	0		0	0	0		0	0	0		1		
Railroad																			
Stopped Buses																			

Comments:

LOCATION: Etheldore St -- California Ave
CITY/STATE: Moss Beach, CA

QC JOB #: 14384612
DATE: Sat, Apr 22 2017

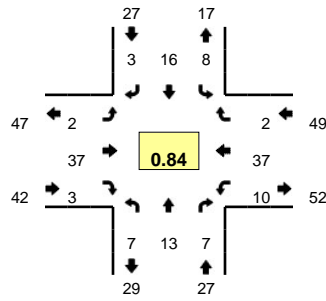

Peak-Hour: 11:45 AM -- 12:45 PM
Peak 15-Min: 12:00 PM -- 12:15 PM

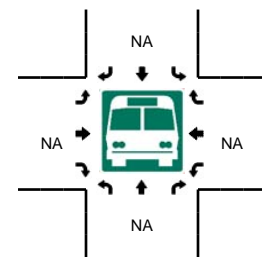
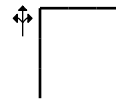
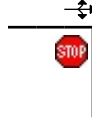
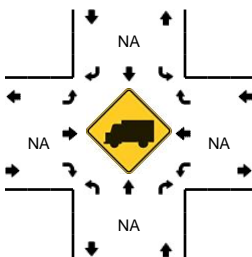
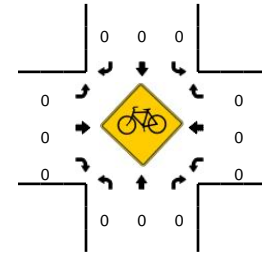
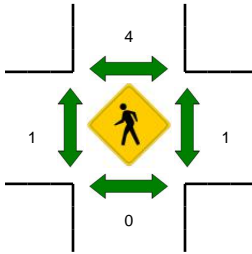
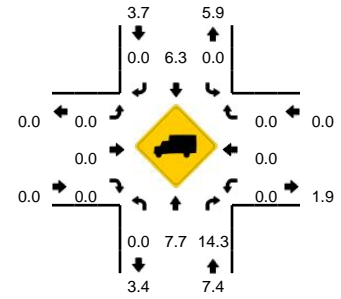

5-Min Count Period Beginning At	Etheldore St (Northbound)				Etheldore St (Southbound)				California Ave (Eastbound)				California Ave (Westbound)				Total	Hourly Totals	
	Left	Thru	Right	U	Left	Thru	Right	U	Left	Thru	Right	U	Left	Thru	Right	U			
11:00 AM	0	2	0	0	0	0	0	0	0	0	3	0	0	0	2	0	0	7	
11:05 AM	1	3	0	0	0	0	0	0	0	0	2	0	0	0	3	0	0	9	
11:10 AM	2	0	0	0	2	1	0	0	0	0	4	0	0	0	5	1	0	15	
11:15 AM	0	1	0	0	2	1	0	0	0	0	2	0	0	0	1	0	0	7	
11:20 AM	0	0	0	0	0	1	0	0	0	0	4	0	0	1	4	0	0	10	
11:25 AM	0	1	1	0	0	1	0	0	0	0	2	1	0	1	2	0	0	9	
11:30 AM	0	1	1	0	1	0	0	0	0	0	4	0	0	0	2	1	0	10	
11:35 AM	0	0	0	0	1	0	0	0	0	0	4	0	0	0	5	0	0	10	
11:40 AM	0	1	0	0	0	1	1	0	0	0	4	0	0	2	4	0	0	13	
11:45 AM	3	1	0	0	0	3	0	0	0	1	4	0	0	0	4	0	0	16	
11:50 AM	1	0	2	0	0	3	0	0	0	0	4	0	0	1	1	0	0	12	
11:55 AM	0	1	0	0	0	1	0	0	0	0	0	1	0	0	5	0	0	8	126
12:00 PM	2	2	1	0	2	2	2	0	0	0	4	0	0	1	2	1	0	19	138
12:05 PM	0	1	0	0	0	1	0	0	0	0	4	0	0	1	6	0	0	13	142
12:10 PM	0	2	1	0	3	1	0	0	0	0	2	1	0	0	1	0	0	11	138
12:15 PM	0	1	0	0	0	3	0	0	0	0	2	0	0	3	3	0	0	12	143
12:20 PM	0	2	2	0	0	0	0	0	0	0	3	0	0	1	2	0	0	10	143
12:25 PM	0	0	0	0	1	2	0	0	0	1	3	0	0	1	2	0	0	10	144
12:30 PM	0	2	0	0	0	0	0	0	0	0	2	0	0	1	3	0	0	8	142
12:35 PM	0	1	1	0	1	0	1	0	0	0	5	0	0	0	2	0	0	11	143
12:40 PM	1	0	0	0	1	0	0	0	0	0	4	1	0	1	6	1	0	15	145
12:45 PM	0	3	1	0	0	1	0	0	0	0	5	0	0	1	0	1	0	12	141
12:50 PM	0	1	0	0	0	4	1	0	0	0	0	0	0	0	0	0	0	6	135
12:55 PM	0	1	2	0	0	0	0	0	0	0	0	0	0	0	1	0	0	4	131
Peak 15-Min Flowrates	Northbound				Southbound				Eastbound				Westbound				Total		
	Left	Thru	Right	U	Left	Thru	Right	U	Left	Thru	Right	U	Left	Thru	Right	U			
All Vehicles	8	20	8	0	20	16	8	0	0	40	4	0	8	36	4	0	172		
Heavy Trucks	0	0	4		0	0	0		0	0	0		0	0	0		4		
Pedestrians		0				8				0				4			12		
Bicycles	0	0	0		0	0	0		0	0	0		0	0	0		0		
Railroad																		0	
Stopped Buses																			

Comments:

LOCATION: Stetson St -- California Ave
CITY/STATE: Moss Beach, CA

QC JOB #: 14384613
DATE: Thu, Apr 20 2017

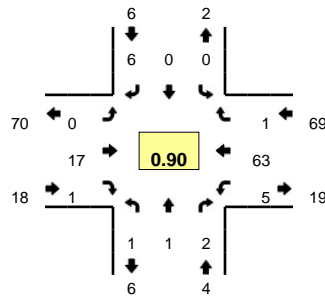

Peak-Hour: 7:30 AM -- 8:30 AM
Peak 15-Min: 7:35 AM -- 7:50 AM

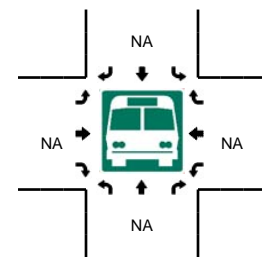
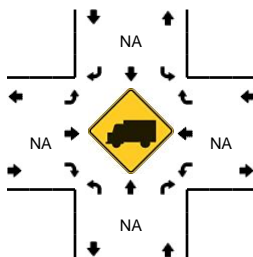
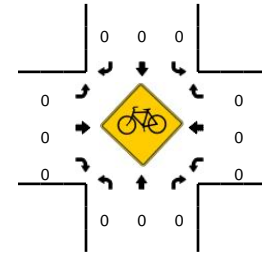
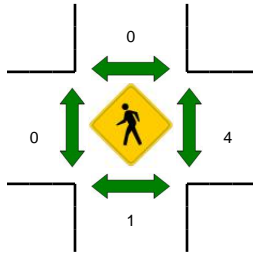
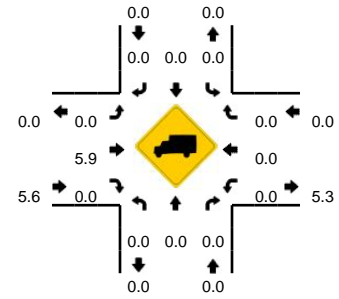

5-Min Count Period Beginning At	Stetson St (Northbound)				Stetson St (Southbound)				California Ave (Eastbound)				California Ave (Westbound)				Total	Hourly Totals
	Left	Thru	Right	U	Left	Thru	Right	U	Left	Thru	Right	U	Left	Thru	Right	U		
7:00 AM	0	0	0	0	0	0	1	0	0	0	0	0	0	5	0	0	6	
7:05 AM	0	0	0	0	0	0	0	0	0	0	0	0	0	5	0	0	5	
7:10 AM	1	0	0	0	0	0	0	0	0	0	0	0	0	2	0	0	3	
7:15 AM	0	0	0	0	0	0	0	0	0	0	0	0	0	10	0	0	10	
7:20 AM	0	0	0	0	0	0	0	0	0	0	0	0	0	4	0	0	4	
7:25 AM	1	0	1	0	0	0	0	0	0	0	0	0	0	7	0	0	9	
7:30 AM	0	0	0	0	0	0	2	0	0	1	0	0	0	5	0	0	8	
7:35 AM	0	0	0	0	0	0	0	0	0	2	1	0	0	5	0	0	8	
7:40 AM	1	0	0	0	0	0	0	0	0	0	0	0	0	8	0	0	9	
7:45 AM	0	0	0	0	0	0	1	0	0	3	0	0	0	5	1	0	10	
7:50 AM	0	0	0	0	0	0	0	0	0	2	0	0	0	6	0	0	8	
7:55 AM	0	0	0	0	0	0	0	0	0	2	0	0	0	6	0	0	8	88
8:00 AM	0	0	0	0	0	0	0	0	0	0	0	0	0	4	0	0	4	86
8:05 AM	0	0	0	0	0	0	1	0	0	2	0	0	0	3	0	0	6	87
8:10 AM	0	0	1	0	0	0	1	0	0	2	0	0	1	6	0	0	11	95
8:15 AM	0	0	0	0	0	0	1	0	0	1	0	0	2	5	0	0	9	94
8:20 AM	0	0	0	0	0	0	0	0	0	0	0	0	2	3	0	0	5	95
8:25 AM	0	1	1	0	0	0	0	0	0	2	0	0	0	7	0	0	11	97
8:30 AM	0	0	1	0	0	0	0	0	0	0	0	0	0	5	0	0	6	95
8:35 AM	0	0	2	0	0	0	0	0	1	2	0	0	0	4	0	0	9	96
8:40 AM	2	0	0	0	0	0	1	0	0	3	0	0	0	1	0	0	7	94
8:45 AM	0	0	0	0	0	0	0	0	0	0	0	0	0	3	0	0	3	87
8:50 AM	0	0	0	0	0	0	1	0	1	0	0	0	0	4	0	0	6	85
8:55 AM	0	0	0	0	0	0	0	0	0	2	0	0	0	4	0	0	6	83
Peak 15-Min Flowrates	Northbound				Southbound				Eastbound				Westbound				Total	
	Left	Thru	Right	U	Left	Thru	Right	U	Left	Thru	Right	U	Left	Thru	Right	U		
All Vehicles	4	0	0	0	0	0	4	0	0	20	4	0	0	72	4	0	108	
Heavy Trucks	0	0	0	0	0	0	0	0	0	0	0	0	0	0	0	0	0	
Pedestrians	0	0	0	0	0	0	0	0	0	0	0	0	0	0	0	0	0	
Bicycles	0	0	0	0	0	0	0	0	0	0	0	0	0	0	0	0	0	
Railroad																		
Stopped Buses																		

Comments:

LOCATION: Stetson St -- California Ave
CITY/STATE: Moss Beach, CA

QC JOB #: 14384614
DATE: Thu, Apr 20 2017

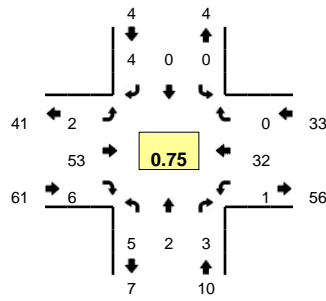

Peak-Hour: 4:30 PM -- 5:30 PM
Peak 15-Min: 5:15 PM -- 5:30 PM

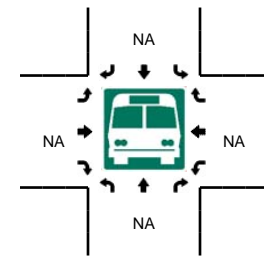
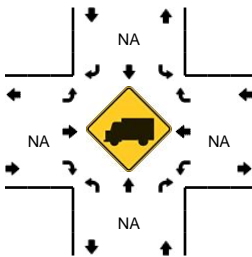
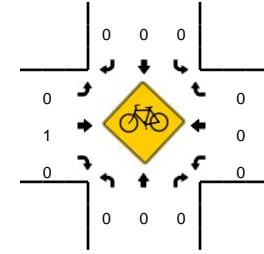
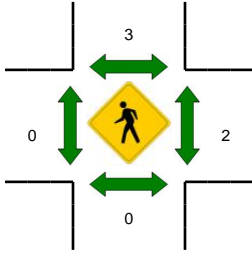
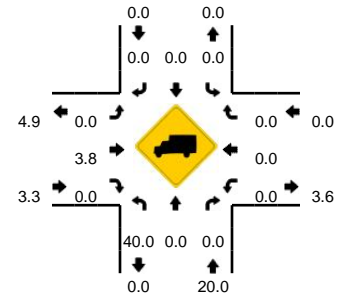

5-Min Count Period Beginning At	Stetson St (Northbound)				Stetson St (Southbound)				California Ave (Eastbound)				California Ave (Westbound)				Total	Hourly Totals
	Left	Thru	Right	U	Left	Thru	Right	U	Left	Thru	Right	U	Left	Thru	Right	U		
4:00 PM	0	0	0	0	0	0	1	0	3	6	0	0	0	1	0	0	11	
4:05 PM	0	0	0	0	0	1	1	0	0	5	0	0	0	0	3	0	10	
4:10 PM	0	0	0	0	0	0	0	0	0	1	0	0	0	0	2	0	3	
4:15 PM	1	1	0	0	0	0	0	0	0	6	0	0	0	0	1	0	9	
4:20 PM	0	0	0	0	0	0	0	0	1	2	0	0	0	0	2	0	5	
4:25 PM	0	0	0	0	0	0	0	0	0	1	0	0	0	1	5	0	7	
4:30 PM	1	1	0	0	0	0	1	0	1	2	0	0	0	0	3	0	9	
4:35 PM	0	0	0	0	0	0	1	0	0	3	0	0	0	0	2	0	6	
4:40 PM	1	0	0	0	0	0	0	0	0	2	0	0	0	0	2	0	5	
4:45 PM	0	0	0	0	0	0	0	0	0	5	1	0	0	0	2	0	8	
4:50 PM	1	0	1	0	0	0	1	0	0	7	1	0	1	2	0	0	14	
4:55 PM	0	0	1	0	0	0	0	0	0	3	0	0	0	1	0	0	5	92
5:00 PM	0	1	0	0	0	0	0	0	1	5	1	0	0	0	3	0	11	92
5:05 PM	0	0	0	0	0	0	0	0	0	6	0	0	0	0	2	0	8	90
5:10 PM	0	0	0	0	0	0	0	0	0	4	1	0	0	0	1	0	6	93
5:15 PM	1	0	0	0	0	0	0	0	0	5	2	0	0	0	4	0	12	96
5:20 PM	1	0	1	0	0	0	1	0	0	2	0	0	0	0	6	0	11	102
5:25 PM	0	0	0	0	0	0	0	0	0	9	0	0	0	0	4	0	13	108
5:30 PM	0	0	0	0	0	0	0	0	1	3	0	0	1	0	0	0	5	104
5:35 PM	0	0	0	0	0	0	0	0	0	3	0	0	0	0	0	0	3	101
5:40 PM	1	0	0	0	0	0	0	0	0	2	0	0	0	0	2	0	5	101
5:45 PM	0	0	0	0	0	0	0	0	0	8	0	0	0	0	3	0	11	104
5:50 PM	0	0	1	0	0	0	2	0	1	4	0	0	0	1	0	0	9	99
5:55 PM	0	0	0	0	0	0	0	0	0	2	0	0	0	0	2	0	4	98
Peak 15-Min Flowrates	Northbound				Southbound				Eastbound				Westbound				Total	
	Left	Thru	Right	U	Left	Thru	Right	U	Left	Thru	Right	U	Left	Thru	Right	U		
All Vehicles	8	0	4	0	0	0	4	0	0	64	8	0	0	56	0	0	144	
Heavy Trucks	8	0	0	0	0	0	0	0	0	4	0	0	0	0	0	0	12	
Pedestrians	0	0	0	0	0	0	0	0	0	0	0	0	0	8	0	0	8	
Bicycles	0	0	0	0	0	0	0	0	0	1	0	0	0	0	0	0	1	
Railroad																		
Stopped Buses																		

Comments:

LOCATION: Stetson St -- California Ave
CITY/STATE: Moss Beach, CA

QC JOB #: 14384615
DATE: Sat, Apr 22 2017

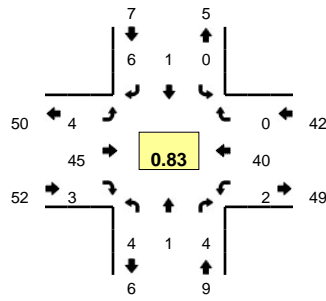

Peak-Hour: 11:10 AM -- 12:10 PM
Peak 15-Min: 11:35 AM -- 11:50 AM

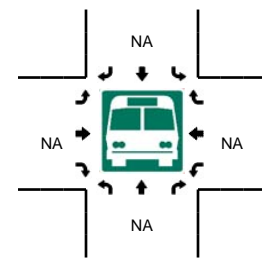
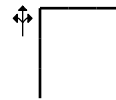
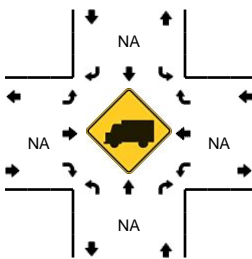
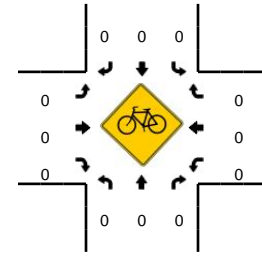
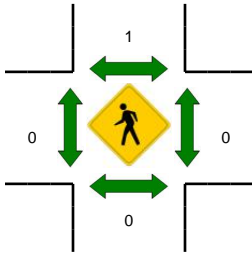
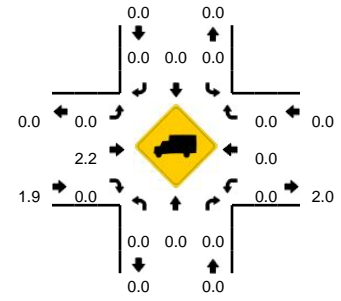

5-Min Count Period Beginning At	Stetson St (Northbound)				Stetson St (Southbound)				California Ave (Eastbound)				California Ave (Westbound)				Total	Hourly Totals	
	Left	Thru	Right	U	Left	Thru	Right	U	Left	Thru	Right	U	Left	Thru	Right	U			
11:00 AM	0	0	0	0	0	0	1	0	1	1	0	0	0	0	0	0	3		
11:05 AM	0	0	1	0	0	0	0	0	0	3	0	0	0	0	1	0	0	5	
11:10 AM	0	0	1	0	0	0	1	0	0	3	0	0	0	0	6	0	0	11	
11:15 AM	1	0	0	0	0	0	0	0	1	4	0	0	0	0	1	0	0	7	
11:20 AM	0	0	1	0	0	0	0	0	0	6	0	0	0	0	4	0	0	11	
11:25 AM	1	0	0	0	0	0	1	0	0	3	0	0	0	0	2	0	0	7	
11:30 AM	0	0	0	0	0	0	1	0	0	1	0	0	0	1	1	0	0	4	
11:35 AM	0	0	0	0	0	0	3	0	2	5	0	0	0	0	4	0	0	14	
11:40 AM	1	0	1	0	0	0	0	0	1	5	0	0	0	0	3	0	0	11	
11:45 AM	1	0	0	0	0	1	0	0	0	2	1	0	0	0	3	0	0	8	
11:50 AM	0	1	1	0	0	0	0	0	0	5	0	0	0	0	3	0	0	10	
11:55 AM	0	0	0	0	0	0	0	0	0	5	0	0	0	0	4	0	0	9	100
12:00 PM	0	0	0	0	0	0	0	0	0	3	1	0	0	1	4	0	0	9	106
12:05 PM	0	0	0	0	0	0	0	0	0	3	1	0	0	0	5	0	0	9	110
12:10 PM	1	0	0	0	0	0	0	0	0	3	0	0	0	0	3	0	0	7	106
12:15 PM	0	0	0	0	0	0	1	0	0	4	0	0	0	0	2	0	0	7	106
12:20 PM	0	0	0	0	0	0	0	0	0	3	0	0	0	0	3	0	0	6	101
12:25 PM	1	0	1	0	0	0	0	0	1	5	0	0	0	0	5	0	0	13	107
12:30 PM	0	0	0	0	0	0	0	0	0	2	1	0	0	0	2	0	0	5	108
12:35 PM	0	0	0	0	0	0	0	0	0	3	1	0	0	0	3	0	0	7	101
12:40 PM	0	0	0	0	0	0	0	0	0	7	0	0	0	0	6	0	0	13	103
12:45 PM	0	0	0	0	0	0	0	0	1	4	0	0	0	0	3	0	0	8	103
12:50 PM	0	0	0	0	0	0	0	0	1	2	0	0	0	0	3	0	0	6	99
12:55 PM	0	0	0	0	0	0	0	0	0	1	0	0	0	0	0	0	0	1	91
Peak 15-Min Flowrates	Northbound				Southbound				Eastbound				Westbound				Total		
	Left	Thru	Right	U	Left	Thru	Right	U	Left	Thru	Right	U	Left	Thru	Right	U			
All Vehicles	8	0	4	0	0	4	12	0	12	48	4	0	0	40	0	0	132		
Heavy Trucks	0	0	0	0	0	0	0	0	0	0	0	0	0	0	0	0	0		
Pedestrians	0	0	0	0	0	4	0	0	0	0	0	0	0	0	0	0	4		
Bicycles	0	0	0	0	0	0	0	0	0	0	0	0	0	0	0	0	0		
Railroad																			
Stopped Buses																			

Comments:

APPENDIX 2. SEASONAL TURNING MOVEMENT COUNT ADJUSTMENTS

Mike Alston

From: Nowinski, Bill@DOT <bill.nowinski@dot.ca.gov>
Sent: Monday, October 23, 2017 9:20 AM
To: Mike Alston; Pribyl, Cindy L@DOT
Cc: Aaron Elias
Subject: RE: Highway 1 Peak Month ADT

Hello Mike,

The method you described would get you the best estimate for this area. Due to road closures due to fires and flooding our data is based on estimates from the surrounding areas. The ratio should give you the best results.

Bill Nowinski
Caltrans, District 5
Traffic Census-south
805-748-4437

From: Mike Alston [<mailto:malston@kittelson.com>]
Sent: Friday, October 20, 2017 12:56 PM
To: Pribyl, Cindy L@DOT <cindy.pribyl@dot.ca.gov>
Cc: Aaron Elias <aelias@kittelson.com>; Nowinski, Bill@DOT <bill.nowinski@dot.ca.gov>
Subject: RE: Highway 1 Peak Month ADT

Great, thank you Cindy.

Mike Alston
Transportation Analyst

[Kittelson & Associates, Inc.](#)
Transportation Engineering / Planning
510.433.8076 (direct)

From: Pribyl, Cindy L@DOT [<mailto:cindy.pribyl@dot.ca.gov>]
Sent: Friday, October 20, 2017 12:49 PM
To: Mike Alston
Cc: Aaron Elias; Nowinski, Bill@DOT
Subject: RE: Highway 1 Peak Month ADT

Hi Mike

I am forwarding your email to the Caltrans local District 5 Traffic Census Staff member Bill Nowinski. I am not familiar with this area's traffic patterns.

Bill is out in the field most days, but he does check his email account.

From: Mike Alston [<mailto:malston@kittelton.com>]
Sent: Friday, October 20, 2017 12:45 PM
To: Pribyl, Cindy L@DOT <cindy.pribyl@dot.ca.gov>
Cc: Aaron Elias <aalias@kittelton.com>
Subject: Highway 1 Peak Month ADT

Hi Cindy,

I am working on a transportation impact study in Moss Beach, California and am hoping you can provide me with some context on what's available on the Caltrans website.

Specifically, I am looking at the PDF "2015 Traffic Volumes on California State Highways."
(http://www.dot.ca.gov/trafficops/census/docs/2015_aadt_volumes.pdf)

For this project, Kittelson & Associates has Highway 1 traffic counts conducted in April 2017 but have been advised that we should find a conversion factor to represent the peak summer conditions. Based on what's in the PDF, I suspect our best option currently would be to use a ratio between **AADT** and the **Peak Month** to inflate them. (our counts as AADT, and our desired summer count number as peak month).

I am writing to ask you if you have any more granular information—specific months, for example, or any other seasonal/time trend related data. In particular, I am looking at SR1 in Caltrans District 4, San Mateo County, and the Vallemar/Etheldore Streets location (postmile 35.334).

Any guidance or more detailed information you could provide in this matter would be greatly appreciated.

Thank you,
Mike Alston

Mike Alston
Transportation Analyst

[Kittelson & Associates, Inc.](#)
Transportation Engineering / Planning
155 Grand Avenue, Suite 900
Oakland, California 94612
510.839.1742
510.433.8076 (direct)



[Streetwise](#) [Twitter](#) [Facebook](#)

APPENDIX 3. EXISTING OPERATIONS RESULTS

Intersection

Int Delay, s/veh 0.4

Movement	WBL	WBR	NBT	NBR	SBL	SBT
Lane Configurations	↘↙		↑	↗		↖
Traffic Vol, veh/h	14	7	679	15	1	567
Future Vol, veh/h	14	7	679	15	1	567
Conflicting Peds, #/hr	0	0	0	0	0	0
Sign Control	Stop	Stop	Free	Free	Free	Free
RT Channelized	-	None	-	None	-	None
Storage Length	0	-	-	125	-	-
Veh in Median Storage, #	0	-	0	-	-	0
Grade, %	0	-	0	-	-	0
Peak Hour Factor	92	92	92	92	92	92
Heavy Vehicles, %	0	0	6	0	0	4
Mvmt Flow	15	8	738	16	1	616

Major/Minor	Minor1		Major1		Major2	
Conflicting Flow All	1356	738	0	0	738	0
Stage 1	738	-	-	-	-	-
Stage 2	618	-	-	-	-	-
Critical Hdwy	6.4	6.2	-	-	4.1	-
Critical Hdwy Stg 1	5.4	-	-	-	-	-
Critical Hdwy Stg 2	5.4	-	-	-	-	-
Follow-up Hdwy	3.5	3.3	-	-	2.2	-
Pot Cap-1 Maneuver	166	421	-	-	877	-
Stage 1	476	-	-	-	-	-
Stage 2	542	-	-	-	-	-
Platoon blocked, %			-	-		
Mov Cap-1 Maneuver	166	421	-	-	877	-
Mov Cap-2 Maneuver	166	-	-	-	-	-
Stage 1	476	-	-	-	-	-
Stage 2	541	-	-	-	-	-

Approach	WB		NB		SB
HCM Control Delay, s	24.4		0		0
HCM LOS	C				

Minor Lane/Major Mvmt	NBT	NBRWBLn1	SBL	SBT
Capacity (veh/h)	-	-	208	877
HCM Lane V/C Ratio	-	-	0.11	0.001
HCM Control Delay (s)	-	-	24.4	9.1
HCM Lane LOS	-	-	C	A
HCM 95th %tile Q(veh)	-	-	0.4	0

Intersection

Int Delay, s/veh 0.1

Movement	EBL	EBT	EBR	WBL	WBT	WBR	NBL	NBT	NBR	SBL	SBT	SBR
Lane Configurations		↔			↔		↑	↑		↑	↑	
Traffic Vol, veh/h	4	0	1	0	0	0	0	684	0	0	593	4
Future Vol, veh/h	4	0	1	0	0	0	0	684	0	0	593	4
Conflicting Peds, #/hr	1	0	0	0	0	1	1	0	1	1	0	1
Sign Control	Stop	Stop	Stop	Stop	Stop	Stop	Free	Free	Free	Free	Free	Free
RT Channelized	-	-	None	-	-	None	-	-	None	-	-	None
Storage Length	-	-	-	-	-	-	65	-	-	50	-	-
Veh in Median Storage, #	-	0	-	-	0	-	-	0	-	-	0	-
Grade, %	-	0	-	-	0	-	-	0	-	-	0	-
Peak Hour Factor	93	93	93	93	93	93	93	93	93	93	93	93
Heavy Vehicles, %	0	0	0	0	0	0	0	6	0	0	4	0
Mvmt Flow	4	0	1	0	0	0	0	735	0	0	638	4

Major/Minor	Minor2			Minor1			Major1			Major2		
Conflicting Flow All	1377	1377	641	1376	1379	737	643	0	0	736	0	0
Stage 1	641	641	-	736	736	-	-	-	-	-	-	-
Stage 2	736	736	-	640	643	-	-	-	-	-	-	-
Critical Hdwy	7.1	6.5	6.2	7.1	6.5	6.2	4.1	-	-	4.1	-	-
Critical Hdwy Stg 1	6.1	5.5	-	6.1	5.5	-	-	-	-	-	-	-
Critical Hdwy Stg 2	6.1	5.5	-	6.1	5.5	-	-	-	-	-	-	-
Follow-up Hdwy	3.5	4	3.3	3.5	4	3.3	2.2	-	-	2.2	-	-
Pot Cap-1 Maneuver	123	146	478	124	146	422	951	-	-	879	-	-
Stage 1	466	473	-	414	428	-	-	-	-	-	-	-
Stage 2	414	428	-	467	472	-	-	-	-	-	-	-
Platoon blocked, %												
Mov Cap-1 Maneuver	123	146	478	124	146	421	951	-	-	878	-	-
Mov Cap-2 Maneuver	123	146	-	124	146	-	-	-	-	-	-	-
Stage 1	466	473	-	414	428	-	-	-	-	-	-	-
Stage 2	414	428	-	466	472	-	-	-	-	-	-	-

Approach	EB	WB	NB	SB
HCM Control Delay, s	31	0	0	0
HCM LOS	D	A		

Minor Lane/Major Mvmt	NBL	NBT	NBR	EBLn1	WBLn1	SBL	SBT	SBR
Capacity (veh/h)	951	-	-	144	-	878	-	-
HCM Lane V/C Ratio	-	-	-	0.037	-	-	-	-
HCM Control Delay (s)	0	-	-	31	0	0	-	-
HCM Lane LOS	A	-	-	D	A	A	-	-
HCM 95th %tile Q(veh)	0	-	-	0.1	-	0	-	-

Intersection

Int Delay, s/veh 0.3

Movement	WBL	WBR	NBT	NBR	SBL	SBT
Lane Configurations	Y		P		T	T
Traffic Vol, veh/h	0	23	658	0	5	582
Future Vol, veh/h	0	23	658	0	5	582
Conflicting Peds, #/hr	0	0	0	0	0	0
Sign Control	Stop	Stop	Free	Free	Free	Free
RT Channelized	-	None	-	None	-	None
Storage Length	0	-	-	-	65	-
Veh in Median Storage, #	0	-	0	-	-	0
Grade, %	0	-	0	-	-	0
Peak Hour Factor	92	92	92	92	92	92
Heavy Vehicles, %	0	0	6	0	0	4
Mvmt Flow	0	25	715	0	5	633

Major/Minor	Minor1		Major1		Major2	
Conflicting Flow All	1358	715	0	0	715	0
Stage 1	715	-	-	-	-	-
Stage 2	643	-	-	-	-	-
Critical Hdwy	6.4	6.2	-	-	4.1	-
Critical Hdwy Stg 1	5.4	-	-	-	-	-
Critical Hdwy Stg 2	5.4	-	-	-	-	-
Follow-up Hdwy	3.5	3.3	-	-	2.2	-
Pot Cap-1 Maneuver	166	434	-	-	895	-
Stage 1	488	-	-	-	-	-
Stage 2	527	-	-	-	-	-
Platoon blocked, %			-	-		
Mov Cap-1 Maneuver	165	434	-	-	895	-
Mov Cap-2 Maneuver	165	-	-	-	-	-
Stage 1	488	-	-	-	-	-
Stage 2	524	-	-	-	-	-

Approach	WB		NB		SB
HCM Control Delay, s	13.8		0		0.1
HCM LOS	B				

Minor Lane/Major Mvmt	NBT	NBRWBLn1	SBL	SBT
Capacity (veh/h)	-	- 434	895	-
HCM Lane V/C Ratio	-	- 0.058	0.006	-
HCM Control Delay (s)	-	- 13.8	9	-
HCM Lane LOS	-	- B	A	-
HCM 95th %tile Q(veh)	-	- 0.2	0	-

Intersection

Int Delay, s/veh 7.6

Movement	WBL	WBR	NBT	NBR	SBL	SBT
Lane Configurations	Y		P			A
Traffic Vol, veh/h	1	22	1	0	5	1
Future Vol, veh/h	1	22	1	0	5	1
Conflicting Peds, #/hr	0	0	0	0	0	0
Sign Control	Stop	Stop	Free	Free	Free	Free
RT Channelized	-	None	-	None	-	None
Storage Length	0	-	-	-	-	-
Veh in Median Storage, #	0	-	0	-	-	0
Grade, %	0	-	0	-	-	0
Peak Hour Factor	75	75	75	75	75	75
Heavy Vehicles, %	0	0	0	0	0	0
Mvmt Flow	1	29	1	0	7	1

Major/Minor	Minor1	Major1	Major2
Conflicting Flow All	16	1	0
Stage 1	1	-	-
Stage 2	15	-	-
Critical Hdwy	6.4	6.2	4.1
Critical Hdwy Stg 1	5.4	-	-
Critical Hdwy Stg 2	5.4	-	-
Follow-up Hdwy	3.5	3.3	2.2
Pot Cap-1 Maneuver	1008	1090	1635
Stage 1	1028	-	-
Stage 2	1013	-	-
Platoon blocked, %			
Mov Cap-1 Maneuver	1004	1090	1635
Mov Cap-2 Maneuver	1004	-	-
Stage 1	1028	-	-
Stage 2	1009	-	-

Approach	WB	NB	SB
HCM Control Delay, s	8.4	0	6
HCM LOS	A		

Minor Lane/Major Mvmt	NBT	NBRWBLn1	SBL	SBT
Capacity (veh/h)	-	- 1086	1635	-
HCM Lane V/C Ratio	-	- 0.028	0.004	-
HCM Control Delay (s)	-	- 8.4	7.2	0
HCM Lane LOS	-	- A	A	A
HCM 95th %tile Q(veh)	-	- 0.1	0	-

Intersection

Int Delay, s/veh 5.7

Movement	EBT	EBR	WBL	WBT	NBL	NBR
Lane Configurations	↔		↔		↔	
Traffic Vol, veh/h	2	3	0	4	18	0
Future Vol, veh/h	2	3	0	4	18	0
Conflicting Peds, #/hr	0	0	0	0	0	1
Sign Control	Free	Free	Free	Free	Stop	Stop
RT Channelized	-	None	-	None	-	None
Storage Length	-	-	-	-	0	-
Veh in Median Storage, #	0	-	-	0	0	-
Grade, %	0	-	-	0	0	-
Peak Hour Factor	70	70	70	70	70	70
Heavy Vehicles, %	0	0	0	0	0	0
Mvmt Flow	3	4	0	6	26	0

Major/Minor	Major1	Major2	Minor1	Minor2
Conflicting Flow All	0	0	7	0
Stage 1	-	-	-	-
Stage 2	-	-	-	-
Critical Hdwy	-	-	4.1	-
Critical Hdwy Stg 1	-	-	-	-
Critical Hdwy Stg 2	-	-	-	-
Follow-up Hdwy	-	-	2.2	-
Pot Cap-1 Maneuver	-	-	1627	-
Stage 1	-	-	-	-
Stage 2	-	-	-	-
Platoon blocked, %	-	-	-	-
Mov Cap-1 Maneuver	-	-	1625	-
Mov Cap-2 Maneuver	-	-	-	-
Stage 1	-	-	-	-
Stage 2	-	-	-	-

Approach	EB	WB	NB
HCM Control Delay, s	0	0	8.6
HCM LOS			A

Minor Lane/Major Mvmt	NBLn1	EBT	EBR	WBL	WBT
Capacity (veh/h)	1014	-	-	1625	-
HCM Lane V/C Ratio	0.025	-	-	-	-
HCM Control Delay (s)	8.6	-	-	0	-
HCM Lane LOS	A	-	-	A	-
HCM 95th %tile Q(veh)	0.1	-	-	0	-

Intersection

Int Delay, s/veh 0.6

Movement	EBL	EBT	EBR	WBL	WBT	WBR	NBL	NBT	NBR	SBL	SBT	SBR
Lane Configurations		↔			↔		↗	↘		↗	↘	
Traffic Vol, veh/h	3	0	5	2	0	26	4	631	4	10	565	0
Future Vol, veh/h	3	0	5	2	0	26	4	631	4	10	565	0
Conflicting Peds, #/hr	0	0	0	0	0	0	1	0	0	0	0	1
Sign Control	Stop	Stop	Stop	Stop	Stop	Stop	Free	Free	Free	Free	Free	Free
RT Channelized	-	-	None	-	-	None	-	-	None	-	-	None
Storage Length	-	-	-	-	-	-	125	-	-	125	-	-
Veh in Median Storage, #	-	0	-	-	0	-	-	0	-	-	0	-
Grade, %	-	0	-	-	0	-	-	0	-	-	0	-
Peak Hour Factor	90	90	90	90	90	90	90	90	90	90	90	90
Heavy Vehicles, %	0	0	0	0	0	4	0	6	0	0	4	0
Mvmt Flow	3	0	6	2	0	29	4	701	4	11	628	0

Major/Minor	Minor2			Minor1			Major1			Major2		
Conflicting Flow All	1378	1365	629	1365	1363	703	629	0	0	706	0	0
Stage 1	651	651	-	712	712	-	-	-	-	-	-	-
Stage 2	727	714	-	653	651	-	-	-	-	-	-	-
Critical Hdwy	7.1	6.5	6.2	7.1	6.5	6.24	4.1	-	-	4.1	-	-
Critical Hdwy Stg 1	6.1	5.5	-	6.1	5.5	-	-	-	-	-	-	-
Critical Hdwy Stg 2	6.1	5.5	-	6.1	5.5	-	-	-	-	-	-	-
Follow-up Hdwy	3.5	4	3.3	3.5	4	3.336	2.2	-	-	2.2	-	-
Pot Cap-1 Maneuver	123	149	486	126	149	434	963	-	-	902	-	-
Stage 1	461	468	-	427	439	-	-	-	-	-	-	-
Stage 2	419	438	-	460	468	-	-	-	-	-	-	-
Platoon blocked, %												
Mov Cap-1 Maneuver	113	146	486	123	146	434	963	-	-	902	-	-
Mov Cap-2 Maneuver	113	146	-	123	146	-	-	-	-	-	-	-
Stage 1	459	462	-	425	437	-	-	-	-	-	-	-
Stage 2	389	436	-	449	462	-	-	-	-	-	-	-

Approach	EB	WB	NB	SB
HCM Control Delay, s	22.3	15.7	0.1	0.2
HCM LOS	C	C		

Minor Lane/Major Mvmt	NBL	NBT	NBR	EBLn1WBLn1	SBL	SBT	SBR
Capacity (veh/h)	963	-	-	217 368	902	-	-
HCM Lane V/C Ratio	0.005	-	-	0.041 0.085	0.012	-	-
HCM Control Delay (s)	8.8	-	-	22.3 15.7	9	-	-
HCM Lane LOS	A	-	-	C C	A	-	-
HCM 95th %tile Q(veh)	0	-	-	0.1 0.3	0	-	-

Intersection

Int Delay, s/veh 2.6

Movement	EBL	EBT	EBR	WBL	WBT	WBR	NBL	NBT	NBR	SBL	SBT	SBR
Lane Configurations		↔			↔		↔	↔		↔	↔	
Traffic Vol, veh/h	10	0	11	48	0	15	4	619	21	6	561	6
Future Vol, veh/h	10	0	11	48	0	15	4	619	21	6	561	6
Conflicting Peds, #/hr	0	0	0	0	0	0	1	0	0	0	0	1
Sign Control	Stop	Stop	Stop	Stop	Stop	Stop	Free	Free	Free	Free	Free	Free
RT Channelized	-	-	None	-	-	None	-	-	None	-	-	None
Storage Length	-	-	-	-	-	-	80	-	-	125	-	-
Veh in Median Storage, #	-	0	-	-	0	-	-	0	-	-	0	-
Grade, %	-	0	-	-	0	-	-	0	-	-	0	-
Peak Hour Factor	93	93	93	93	93	93	93	93	93	93	93	93
Heavy Vehicles, %	2	2	2	2	2	2	2	2	2	2	2	2
Mvmt Flow	11	0	12	52	0	16	4	666	23	6	603	6

Major/Minor	Minor2			Minor1			Major1			Major2		
Conflicting Flow All	1314	1317	607	1310	1309	677	611	0	0	688	0	0
Stage 1	620	620	-	685	685	-	-	-	-	-	-	-
Stage 2	694	697	-	625	624	-	-	-	-	-	-	-
Critical Hdwy	7.12	6.52	6.22	7.12	6.52	6.22	4.12	-	-	4.12	-	-
Critical Hdwy Stg 1	6.12	5.52	-	6.12	5.52	-	-	-	-	-	-	-
Critical Hdwy Stg 2	6.12	5.52	-	6.12	5.52	-	-	-	-	-	-	-
Follow-up Hdwy	3.518	4.018	3.318	3.518	4.018	3.318	2.218	-	-	2.218	-	-
Pot Cap-1 Maneuver	135	157	496	136	159	453	968	-	-	906	-	-
Stage 1	476	480	-	438	448	-	-	-	-	-	-	-
Stage 2	433	443	-	473	478	-	-	-	-	-	-	-
Platoon blocked, %												
Mov Cap-1 Maneuver	129	155	496	132	157	453	968	-	-	906	-	-
Mov Cap-2 Maneuver	129	155	-	132	157	-	-	-	-	-	-	-
Stage 1	474	476	-	436	446	-	-	-	-	-	-	-
Stage 2	416	441	-	459	474	-	-	-	-	-	-	-

Approach	EB	WB	NB	SB
HCM Control Delay, s	24.1	43.5	0.1	0.1
HCM LOS	C	E		

Minor Lane/Major Mvmt	NBL	NBT	NBR	EBLn1	WBLn1	SBL	SBT	SBR
Capacity (veh/h)	968	-	-	211	159	906	-	-
HCM Lane V/C Ratio	0.004	-	-	0.107	0.426	0.007	-	-
HCM Control Delay (s)	8.7	-	-	24.1	43.5	9	-	-
HCM Lane LOS	A	-	-	C	E	A	-	-
HCM 95th %tile Q(veh)	0	-	-	0.4	1.9	0	-	-

Intersection

Int Delay, s/veh 1.6

Movement	EBL	EBT	EBR	WBL	WBT	WBR	NBL	NBT	NBR	SBL	SBT	SBR
Lane Configurations		↕			↕			↕			↕	
Traffic Vol, veh/h	6	16	0	1	65	0	3	2	0	2	2	3
Future Vol, veh/h	6	16	0	1	65	0	3	2	0	2	2	3
Conflicting Peds, #/hr	1	0	0	0	0	1	0	0	1	1	0	0
Sign Control	Free	Free	Free	Free	Free	Free	Stop	Stop	Stop	Stop	Stop	Stop
RT Channelized	-	-	None	-	-	None	-	-	None	-	-	None
Storage Length	-	-	-	-	-	-	-	-	-	-	-	-
Veh in Median Storage, #	-	0	-	-	0	-	-	0	-	-	0	-
Grade, %	-	0	-	-	0	-	-	0	-	-	0	-
Peak Hour Factor	74	74	74	74	74	74	74	74	74	74	74	74
Heavy Vehicles, %	0	0	0	0	0	0	33	0	0	0	0	0
Mvmt Flow	8	22	0	1	88	0	4	3	0	3	3	4

Major/Minor	Major1			Major2			Minor1			Minor2		
Conflicting Flow All	89	0	0	22	0	0	132	130	23	132	130	89
Stage 1	-	-	-	-	-	-	38	38	-	92	92	-
Stage 2	-	-	-	-	-	-	94	92	-	40	38	-
Critical Hdwy	4.1	-	-	4.1	-	-	7.43	6.5	6.2	7.1	6.5	6.2
Critical Hdwy Stg 1	-	-	-	-	-	-	6.43	5.5	-	6.1	5.5	-
Critical Hdwy Stg 2	-	-	-	-	-	-	6.43	5.5	-	6.1	5.5	-
Follow-up Hdwy	2.2	-	-	2.2	-	-	3.797	4	3.3	3.5	4	3.3
Pot Cap-1 Maneuver	1519	-	-	1607	-	-	773	764	1060	845	764	975
Stage 1	-	-	-	-	-	-	904	867	-	920	823	-
Stage 2	-	-	-	-	-	-	842	823	-	980	867	-
Platoon blocked, %		-	-		-	-						
Mov Cap-1 Maneuver	1519	-	-	1605	-	-	764	759	1059	837	759	974
Mov Cap-2 Maneuver	-	-	-	-	-	-	764	759	-	837	759	-
Stage 1	-	-	-	-	-	-	899	863	-	915	821	-
Stage 2	-	-	-	-	-	-	835	821	-	971	863	-

Approach	EB	WB	NB	SB
HCM Control Delay, s	2	0.1	9.8	9.2
HCM LOS			A	A

Minor Lane/Major Mvmt	NBLn1	EBL	EBT	EBR	WBL	WBT	WBR	SBLn1
Capacity (veh/h)	762	1519	-	-	1605	-	-	864
HCM Lane V/C Ratio	0.009	0.005	-	-	0.001	-	-	0.011
HCM Control Delay (s)	9.8	7.4	0	-	7.2	0	-	9.2
HCM Lane LOS	A	A	A	-	A	A	-	A
HCM 95th %tile Q(veh)	0	0	-	-	0	-	-	0

Intersection

Int Delay, s/veh 7.7

Movement	EBL	EBT	EBR	WBL	WBT	WBR	NBL	NBT	NBR	SBL	SBT	SBR
Lane Configurations		↕			↕			↕			↕	
Traffic Vol, veh/h	0	14	0	1	65	9	2	17	0	1	4	0
Future Vol, veh/h	0	14	0	1	65	9	2	17	0	1	4	0
Conflicting Peds, #/hr	1	0	0	0	0	1	0	0	0	0	0	0
Sign Control	Stop	Stop	Stop	Stop	Stop	Stop	Free	Free	Free	Free	Free	Free
RT Channelized	-	-	None	-	-	None	-	-	None	-	-	None
Storage Length	-	-	-	-	-	-	-	-	-	-	-	-
Veh in Median Storage, #	-	0	-	-	0	-	-	0	-	-	0	-
Grade, %	-	0	-	-	0	-	-	0	-	-	0	-
Peak Hour Factor	83	83	83	83	83	83	83	83	83	83	83	83
Heavy Vehicles, %	0	0	0	0	0	0	0	6	0	0	0	0
Mvmt Flow	0	17	0	1	78	11	2	20	0	1	5	0

Major/Minor	Minor2			Minor1			Major1			Major2		
Conflicting Flow All	78	32	5	41	32	21	5	0	0	20	0	0
Stage 1	7	7	-	25	25	-	-	-	-	-	-	-
Stage 2	71	25	-	16	7	-	-	-	-	-	-	-
Critical Hdwy	7.1	6.5	6.2	7.1	6.5	6.2	4.1	-	-	4.1	-	-
Critical Hdwy Stg 1	6.1	5.5	-	6.1	5.5	-	-	-	-	-	-	-
Critical Hdwy Stg 2	6.1	5.5	-	6.1	5.5	-	-	-	-	-	-	-
Follow-up Hdwy	3.5	4	3.3	3.5	4	3.3	2.2	-	-	2.2	-	-
Pot Cap-1 Maneuver	916	865	1084	968	865	1062	1630	-	-	1609	-	-
Stage 1	1020	894	-	998	878	-	-	-	-	-	-	-
Stage 2	944	878	-	1009	894	-	-	-	-	-	-	-
Platoon blocked, %												
Mov Cap-1 Maneuver	842	863	1084	952	863	1061	1630	-	-	1607	-	-
Mov Cap-2 Maneuver	842	863	-	952	863	-	-	-	-	-	-	-
Stage 1	1019	893	-	997	877	-	-	-	-	-	-	-
Stage 2	849	877	-	989	893	-	-	-	-	-	-	-

Approach	EB	WB	NB	SB
HCM Control Delay, s	9.3	9.5	0.8	1.4
HCM LOS	A	A		

Minor Lane/Major Mvmt	NBL	NBT	NBR	EBLn1WBLn1	SBL	SBT	SBR
Capacity (veh/h)	1630	-	-	863 884	1607	-	-
HCM Lane V/C Ratio	0.001	-	-	0.02 0.102	0.001	-	-
HCM Control Delay (s)	7.2	0	-	9.3 9.5	7.2	0	-
HCM Lane LOS	A	A	-	A A	A	A	-
HCM 95th %tile Q(veh)	0	-	-	0.1 0.3	0	-	-

Intersection	
Intersection Delay, s/veh	7.2
Intersection LOS	A

Movement	EBU	EBL	EBT	EBR	WBU	WBL	WBT	WBR	NBU	NBL	NBT	NBR
Lane Configurations			↕				↕				↕	
Traffic Vol, veh/h	0	0	17	1	0	5	63	1	0	1	1	2
Future Vol, veh/h	0	0	17	1	0	5	63	1	0	1	1	2
Peak Hour Factor	0.92	0.90	0.90	0.90	0.92	0.90	0.90	0.90	0.92	0.90	0.90	0.90
Heavy Vehicles, %	2	0	6	0	2	0	0	0	2	0	0	0
Mvmt Flow	0	0	19	1	0	6	70	1	0	1	1	2
Number of Lanes	0	0	1	0	0	0	1	0	0	0	1	0

Approach	EB	WB	NB
Opposing Approach	WB	EB	SB
Opposing Lanes	1	1	1
Conflicting Approach Left	SB	NB	EB
Conflicting Lanes Left	1	1	1
Conflicting Approach Right	NB	SB	WB
Conflicting Lanes Right	1	1	1
HCM Control Delay	7.2	7.3	6.9
HCM LOS	A	A	A

Lane	NBLn1	EBLn1	WBLn1	SBLn1
Vol Left, %	25%	0%	7%	0%
Vol Thru, %	25%	94%	91%	0%
Vol Right, %	50%	6%	1%	100%
Sign Control	Stop	Stop	Stop	Stop
Traffic Vol by Lane	4	18	69	6
LT Vol	1	0	5	0
Through Vol	1	17	63	0
RT Vol	2	1	1	6
Lane Flow Rate	4	20	77	7
Geometry Grp	1	1	1	1
Degree of Util (X)	0.005	0.022	0.084	0.006
Departure Headway (Hd)	3.823	4.045	3.94	3.47
Convergence, Y/N	Yes	Yes	Yes	Yes
Cap	932	887	913	1026
Service Time	1.861	2.061	1.946	1.51
HCM Lane V/C Ratio	0.004	0.023	0.084	0.007
HCM Control Delay	6.9	7.2	7.3	6.5
HCM Lane LOS	A	A	A	A
HCM 95th-tile Q	0	0.1	0.3	0

Intersection

Intersection Delay, s/veh

Intersection LOS

Movement	SBU	SBL	SBT	SBR
Lane Configurations			↕	
Traffic Vol, veh/h	0	0	0	6
Future Vol, veh/h	0	0	0	6
Peak Hour Factor	0.92	0.90	0.90	0.90
Heavy Vehicles, %	2	0	0	0
Mvmt Flow	0	0	0	7
Number of Lanes	0	0	1	0

Approach SB

Opposing Approach	NB
Opposing Lanes	1
Conflicting Approach Left	WB
Conflicting Lanes Left	1
Conflicting Approach Right	EB
Conflicting Lanes Right	1
HCM Control Delay	6.5
HCM LOS	A

Intersection

Int Delay, s/veh 0.2

Movement	EBL	EBR	NBL	NBT	SBT	SBR
Lane Configurations	Y			Y	Y	
Traffic Vol, veh/h	3	6	7	638	567	0
Future Vol, veh/h	3	6	7	638	567	0
Conflicting Peds, #/hr	0	0	1	0	0	1
Sign Control	Stop	Stop	Free	Free	Free	Free
RT Channelized	-	None	-	None	-	None
Storage Length	0	-	-	-	-	-
Veh in Median Storage, #	0	-	-	0	0	-
Grade, %	0	-	-	0	0	-
Peak Hour Factor	93	93	93	93	93	93
Heavy Vehicles, %	2	2	2	2	2	2
Mvmt Flow	3	6	8	686	610	0

Major/Minor	Minor2	Major1		Major2	
Conflicting Flow All	1312	611	611	0	0
Stage 1	611	-	-	-	-
Stage 2	701	-	-	-	-
Critical Hdwy	6.42	6.22	4.12	-	-
Critical Hdwy Stg 1	5.42	-	-	-	-
Critical Hdwy Stg 2	5.42	-	-	-	-
Follow-up Hdwy	3.518	3.318	2.218	-	-
Pot Cap-1 Maneuver	175	494	968	-	-
Stage 1	542	-	-	-	-
Stage 2	492	-	-	-	-
Platoon blocked, %				-	-
Mov Cap-1 Maneuver	172	494	968	-	-
Mov Cap-2 Maneuver	172	-	-	-	-
Stage 1	541	-	-	-	-
Stage 2	485	-	-	-	-

Approach	EB	NB	SB
HCM Control Delay, s	17.2	0.1	0
HCM LOS	C		

Minor Lane/Major Mvmt	NBL	NBT	EBLn1	SBT	SBR
Capacity (veh/h)	968	-	304	-	-
HCM Lane V/C Ratio	0.008	-	0.032	-	-
HCM Control Delay (s)	8.7	0	17.2	-	-
HCM Lane LOS	A	A	C	-	-
HCM 95th %tile Q(veh)	0	-	0.1	-	-

Intersection

Int Delay, s/veh 0.4

Movement	WBL	WBR	NBT	NBR	SBL	SBT
Lane Configurations	↘↙		↑	↗		↖
Traffic Vol, veh/h	11	5	671	18	5	862
Future Vol, veh/h	11	5	671	18	5	862
Conflicting Peds, #/hr	0	0	0	1	1	0
Sign Control	Stop	Stop	Free	Free	Free	Free
RT Channelized	-	None	-	None	-	None
Storage Length	0	-	-	125	-	-
Veh in Median Storage, #	0	-	0	-	-	0
Grade, %	0	-	0	-	-	0
Peak Hour Factor	95	95	95	95	95	95
Heavy Vehicles, %	0	0	2	0	0	2
Mvmt Flow	12	5	706	19	5	907

Major/Minor	Minor1		Major1		Major2	
Conflicting Flow All	1625	707	0	0	707	0
Stage 1	707	-	-	-	-	-
Stage 2	918	-	-	-	-	-
Critical Hdwy	6.4	6.2	-	-	4.1	-
Critical Hdwy Stg 1	5.4	-	-	-	-	-
Critical Hdwy Stg 2	5.4	-	-	-	-	-
Follow-up Hdwy	3.5	3.3	-	-	2.2	-
Pot Cap-1 Maneuver	114	439	-	-	901	-
Stage 1	493	-	-	-	-	-
Stage 2	392	-	-	-	-	-
Platoon blocked, %			-	-		
Mov Cap-1 Maneuver	113	439	-	-	901	-
Mov Cap-2 Maneuver	113	-	-	-	-	-
Stage 1	493	-	-	-	-	-
Stage 2	388	-	-	-	-	-

Approach	WB		NB		SB
HCM Control Delay, s	32.6		0		0.1
HCM LOS	D				

Minor Lane/Major Mvmt	NBT	NBRWBLn1	SBL	SBT
Capacity (veh/h)	-	- 147	901	-
HCM Lane V/C Ratio	-	- 0.115	0.006	-
HCM Control Delay (s)	-	- 32.6	9	0
HCM Lane LOS	-	- D	A	A
HCM 95th %tile Q(veh)	-	- 0.4	0	-

Intersection

Int Delay, s/veh 0.3

Movement	EBL	EBT	EBR	WBL	WBT	WBR	NBL	NBT	NBR	SBL	SBT	SBR
Lane Configurations		↔			↔		↑	↑		↑	↑	
Traffic Vol, veh/h	5	0	4	1	0	2	0	683	0	1	858	4
Future Vol, veh/h	5	0	4	1	0	2	0	683	0	1	858	4
Conflicting Peds, #/hr	5	0	0	0	0	5	0	0	4	4	0	0
Sign Control	Stop	Stop	Stop	Stop	Stop	Stop	Free	Free	Free	Free	Free	Free
RT Channelized	-	-	None	-	-	None	-	-	None	-	-	None
Storage Length	-	-	-	-	-	-	65	-	-	50	-	-
Veh in Median Storage, #	-	0	-	-	0	-	-	0	-	-	0	-
Grade, %	-	0	-	-	0	-	-	0	-	-	0	-
Peak Hour Factor	94	94	94	94	94	94	94	94	94	94	94	94
Heavy Vehicles, %	0	0	0	0	0	0	0	2	0	0	1	0
Mvmt Flow	5	0	4	1	0	2	0	727	0	1	913	4

Major/Minor	Minor2			Minor1			Major1			Major2		
Conflicting Flow All	1650	1648	915	1650	1650	736	917	0	0	731	0	0
Stage 1	917	917	-	731	731	-	-	-	-	-	-	-
Stage 2	733	731	-	919	919	-	-	-	-	-	-	-
Critical Hdwy	7.1	6.5	6.2	7.1	6.5	6.2	4.1	-	-	4.1	-	-
Critical Hdwy Stg 1	6.1	5.5	-	6.1	5.5	-	-	-	-	-	-	-
Critical Hdwy Stg 2	6.1	5.5	-	6.1	5.5	-	-	-	-	-	-	-
Follow-up Hdwy	3.5	4	3.3	3.5	4	3.3	2.2	-	-	2.2	-	-
Pot Cap-1 Maneuver	80	100	333	80	100	422	752	-	-	883	-	-
Stage 1	329	354	-	416	430	-	-	-	-	-	-	-
Stage 2	415	430	-	328	353	-	-	-	-	-	-	-
Platoon blocked, %												
Mov Cap-1 Maneuver	79	100	333	79	100	418	752	-	-	879	-	-
Mov Cap-2 Maneuver	79	100	-	79	100	-	-	-	-	-	-	-
Stage 1	329	354	-	414	428	-	-	-	-	-	-	-
Stage 2	411	428	-	323	353	-	-	-	-	-	-	-

Approach	EB	WB	NB	SB
HCM Control Delay, s	37.6	26.3	0	0
HCM LOS	E	D		

Minor Lane/Major Mvmt	NBL	NBT	NBR	EBLn1WBLn1	SBL	SBT	SBR
Capacity (veh/h)	752	-	-	120 172	879	-	-
HCM Lane V/C Ratio	-	-	-	0.08 0.019	0.001	-	-
HCM Control Delay (s)	0	-	-	37.6 26.3	9.1	-	-
HCM Lane LOS	A	-	-	E D	A	-	-
HCM 95th %tile Q(veh)	0	-	-	0.3 0.1	0	-	-

Intersection

Int Delay, s/veh 0.2

Movement	WBL	WBR	NBT	NBR	SBL	SBT
Lane Configurations	Y		P		T	T
Traffic Vol, veh/h	0	5	678	0	18	851
Future Vol, veh/h	0	5	678	0	18	851
Conflicting Peds, #/hr	0	0	0	2	2	0
Sign Control	Stop	Stop	Free	Free	Free	Free
RT Channelized	-	None	-	None	-	None
Storage Length	0	-	-	-	65	-
Veh in Median Storage, #	0	-	0	-	-	0
Grade, %	0	-	0	-	-	0
Peak Hour Factor	96	96	96	96	96	96
Heavy Vehicles, %	0	0	2	0	0	2
Mvmt Flow	0	5	706	0	19	886

Major/Minor	Minor1		Major1		Major2	
Conflicting Flow All	1632	708	0	0	708	0
Stage 1	708	-	-	-	-	-
Stage 2	924	-	-	-	-	-
Critical Hdwy	7.1	6.2	-	-	4.1	-
Critical Hdwy Stg 1	6.1	-	-	-	-	-
Critical Hdwy Stg 2	6.1	-	-	-	-	-
Follow-up Hdwy	3.5	3.3	-	-	2.2	-
Pot Cap-1 Maneuver	82	438	-	-	900	-
Stage 1	429	-	-	-	-	-
Stage 2	326	-	-	-	-	-
Platoon blocked, %			-	-		
Mov Cap-1 Maneuver	81	437	-	-	900	-
Mov Cap-2 Maneuver	81	-	-	-	-	-
Stage 1	429	-	-	-	-	-
Stage 2	319	-	-	-	-	-

Approach	WB		NB		SB
HCM Control Delay, s	13.3		0		0.2
HCM LOS	B				

Minor Lane/Major Mvmt	NBT	NBRWBLn1	SBL	SBT
Capacity (veh/h)	-	- 437	900	-
HCM Lane V/C Ratio	-	- 0.012	0.021	-
HCM Control Delay (s)	-	- 13.3	9.1	-
HCM Lane LOS	-	- B	A	-
HCM 95th %tile Q(veh)	-	- 0	0.1	-

Intersection

Int Delay, s/veh 6.3

Movement	WBL	WBR	NBT	NBR	SBL	SBT
Lane Configurations	Y		P			A
Traffic Vol, veh/h	4	6	1	6	19	0
Future Vol, veh/h	4	6	1	6	19	0
Conflicting Peds, #/hr	1	0	0	5	5	0
Sign Control	Stop	Stop	Free	Free	Free	Free
RT Channelized	-	None	-	None	-	None
Storage Length	0	-	-	-	-	-
Veh in Median Storage, #	0	-	0	-	-	0
Grade, %	0	-	0	-	-	0
Peak Hour Factor	75	75	75	75	75	75
Heavy Vehicles, %	0	17	0	0	0	0
Mvmt Flow	5	8	1	8	25	0

Major/Minor	Minor1		Major1		Major2	
Conflicting Flow All	62	10	0	0	14	0
Stage 1	10	-	-	-	-	-
Stage 2	52	-	-	-	-	-
Critical Hdwy	6.4	6.37	-	-	4.1	-
Critical Hdwy Stg 1	5.4	-	-	-	-	-
Critical Hdwy Stg 2	5.4	-	-	-	-	-
Follow-up Hdwy	3.5	3.453	-	-	2.2	-
Pot Cap-1 Maneuver	949	1029	-	-	1617	-
Stage 1	1018	-	-	-	-	-
Stage 2	976	-	-	-	-	-
Platoon blocked, %			-	-		-
Mov Cap-1 Maneuver	929	1024	-	-	1617	-
Mov Cap-2 Maneuver	929	-	-	-	-	-
Stage 1	1013	-	-	-	-	-
Stage 2	960	-	-	-	-	-

Approach	WB		NB		SB
HCM Control Delay, s	8.7		0		7.3
HCM LOS	A				

Minor Lane/Major Mvmt	NBT	NBRWBLn1	SBL	SBT
Capacity (veh/h)	-	-	984	1617
HCM Lane V/C Ratio	-	-	0.014	0.016
HCM Control Delay (s)	-	-	8.7	7.3
HCM Lane LOS	-	-	A	A
HCM 95th %tile Q(veh)	-	-	0	0

Intersection

Int Delay, s/veh 2

Movement	EBT	EBR	WBL	WBT	NBL	NBR
Lane Configurations	↔		↔		↔	
Traffic Vol, veh/h	8	16	1	4	7	0
Future Vol, veh/h	8	16	1	4	7	0
Conflicting Peds, #/hr	0	3	3	0	1	0
Sign Control	Free	Free	Free	Free	Stop	Stop
RT Channelized	-	None	-	None	-	None
Storage Length	-	-	-	-	0	-
Veh in Median Storage, #	0	-	-	0	0	-
Grade, %	0	-	-	0	0	-
Peak Hour Factor	69	69	69	69	69	69
Heavy Vehicles, %	0	0	0	0	29	0
Mvmt Flow	12	23	1	6	10	0

Major/Minor	Major1	Major2	Minor1
Conflicting Flow All	0	0	36
Stage 1	-	-	26
Stage 2	-	-	10
Critical Hdwy	-	4.1	6.69
Critical Hdwy Stg 1	-	-	5.69
Critical Hdwy Stg 2	-	-	5.69
Follow-up Hdwy	-	2.2	3.761
Pot Cap-1 Maneuver	-	1585	912
Stage 1	-	-	931
Stage 2	-	-	947
Platoon blocked, %	-	-	-
Mov Cap-1 Maneuver	-	1585	908
Mov Cap-2 Maneuver	-	-	908
Stage 1	-	-	928
Stage 2	-	-	945

Approach	EB	WB	NB
HCM Control Delay, s	0	1.5	9
HCM LOS			A

Minor Lane/Major Mvmt	NBLn1	EBT	EBR	WBL	WBT
Capacity (veh/h)	908	-	-	1585	-
HCM Lane V/C Ratio	0.011	-	-	0.001	-
HCM Control Delay (s)	9	-	-	7.3	0
HCM Lane LOS	A	-	-	A	A
HCM 95th %tile Q(veh)	0	-	-	0	-

Intersection

Int Delay, s/veh 1

Movement	EBL	EBT	EBR	WBL	WBT	WBR	NBL	NBT	NBR	SBL	SBT	SBR
Lane Configurations		↔			↔		↑	↑		↑	↑	
Traffic Vol, veh/h	7	0	7	7	0	17	10	655	7	28	812	5
Future Vol, veh/h	7	0	7	7	0	17	10	655	7	28	812	5
Conflicting Peds, #/hr	0	0	0	0	0	0	0	0	2	2	0	0
Sign Control	Stop	Stop	Stop	Stop	Stop	Stop	Free	Free	Free	Free	Free	Free
RT Channelized	-	-	None	-	-	None	-	-	None	-	-	None
Storage Length	-	-	-	-	-	-	125	-	-	125	-	-
Veh in Median Storage, #	-	0	-	-	0	-	-	0	-	-	0	-
Grade, %	-	0	-	-	0	-	-	0	-	-	0	-
Peak Hour Factor	96	96	96	96	96	96	96	96	96	96	96	96
Heavy Vehicles, %	0	0	0	0	0	0	0	2	14	7	2	0
Mvmt Flow	7	0	7	7	0	18	10	682	7	29	846	5

Major/Minor	Minor2			Minor1			Major1			Major2		
Conflicting Flow All	1623	1619	848	1619	1618	688	851	0	0	692	0	0
Stage 1	907	907	-	709	709	-	-	-	-	-	-	-
Stage 2	716	712	-	910	909	-	-	-	-	-	-	-
Critical Hdwy	7.1	6.5	6.2	7.1	6.5	6.2	4.1	-	-	4.17	-	-
Critical Hdwy Stg 1	6.1	5.5	-	6.1	5.5	-	-	-	-	-	-	-
Critical Hdwy Stg 2	6.1	5.5	-	6.1	5.5	-	-	-	-	-	-	-
Follow-up Hdwy	3.5	4	3.3	3.5	4	3.3	2.2	-	-	2.263	-	-
Pot Cap-1 Maneuver	83	104	364	84	104	450	796	-	-	880	-	-
Stage 1	333	357	-	428	440	-	-	-	-	-	-	-
Stage 2	424	439	-	332	357	-	-	-	-	-	-	-
Platoon blocked, %												
Mov Cap-1 Maneuver	77	99	364	79	99	449	796	-	-	880	-	-
Mov Cap-2 Maneuver	77	99	-	79	99	-	-	-	-	-	-	-
Stage 1	329	345	-	422	434	-	-	-	-	-	-	-
Stage 2	402	433	-	315	345	-	-	-	-	-	-	-

Approach	EB	WB	NB	SB
HCM Control Delay, s	37	26.8	0.1	0.3
HCM LOS	E	D		

Minor Lane/Major Mvmt	NBL	NBT	NBR	EBLn1	WBLn1	SBL	SBT	SBR
Capacity (veh/h)	796	-	-	127	190	880	-	-
HCM Lane V/C Ratio	0.013	-	-	0.115	0.132	0.033	-	-
HCM Control Delay (s)	9.6	-	-	37	26.8	9.2	-	-
HCM Lane LOS	A	-	-	E	D	A	-	-
HCM 95th %tile Q(veh)	0	-	-	0.4	0.4	0.1	-	-

Intersection

Int Delay, s/veh 2.5

Movement	EBL	EBT	EBR	WBL	WBT	WBR	NBL	NBT	NBR	SBL	SBT	SBR
Lane Configurations		↔			↔		↔	↔		↔	↔	
Traffic Vol, veh/h	3	0	3	32	0	13	5	660	42	17	806	10
Future Vol, veh/h	3	0	3	32	0	13	5	660	42	17	806	10
Conflicting Peds, #/hr	1	0	0	0	0	1	1	0	0	0	0	1
Sign Control	Stop	Stop	Stop	Stop	Stop	Stop	Free	Free	Free	Free	Free	Free
RT Channelized	-	-	None	-	-	None	-	-	None	-	-	None
Storage Length	-	-	-	-	-	-	80	-	-	125	-	-
Veh in Median Storage, #	-	0	-	-	0	-	-	0	-	-	0	-
Grade, %	-	0	-	-	0	-	-	0	-	-	0	-
Peak Hour Factor	91	91	91	91	91	91	91	91	91	91	91	91
Heavy Vehicles, %	2	2	2	2	2	2	2	2	2	2	2	2
Mvmt Flow	3	0	3	35	0	14	5	725	46	19	886	11

Major/Minor	Minor2			Minor1			Major1			Major2		
Conflicting Flow All	1697	1712	892	1689	1694	749	898	0	0	771	0	0
Stage 1	930	930	-	759	759	-	-	-	-	-	-	-
Stage 2	767	782	-	930	935	-	-	-	-	-	-	-
Critical Hdwy	7.12	6.52	6.22	7.12	6.52	6.22	4.12	-	-	4.12	-	-
Critical Hdwy Stg 1	6.12	5.52	-	6.12	5.52	-	-	-	-	-	-	-
Critical Hdwy Stg 2	6.12	5.52	-	6.12	5.52	-	-	-	-	-	-	-
Follow-up Hdwy	3.518	4.018	3.318	3.518	4.018	3.318	2.218	-	-	2.218	-	-
Pot Cap-1 Maneuver	73	90	341	74	93	412	756	-	-	844	-	-
Stage 1	321	346	-	399	415	-	-	-	-	-	-	-
Stage 2	395	405	-	321	344	-	-	-	-	-	-	-
Platoon blocked, %												
Mov Cap-1 Maneuver	69	87	341	72	90	412	756	-	-	843	-	-
Mov Cap-2 Maneuver	69	87	-	72	90	-	-	-	-	-	-	-
Stage 1	319	338	-	396	412	-	-	-	-	-	-	-
Stage 2	378	402	-	311	336	-	-	-	-	-	-	-

Approach	EB	WB	NB	SB
HCM Control Delay, s	38.2	78.2	0.1	0.2
HCM LOS	E	F		

Minor Lane/Major Mvmt	NBL	NBT	NBR	EBLn1	WBLn1	SBL	SBT	SBR
Capacity (veh/h)	756	-	-	115	95	843	-	-
HCM Lane V/C Ratio	0.007	-	-	0.057	0.521	0.022	-	-
HCM Control Delay (s)	9.8	-	-	38.2	78.2	9.4	-	-
HCM Lane LOS	A	-	-	E	F	A	-	-
HCM 95th %tile Q(veh)	0	-	-	0.2	2.3	0.1	-	-

Intersection

Int Delay, s/veh 3.9

Movement	EBL	EBT	EBR	WBL	WBT	WBR	NBL	NBT	NBR	SBL	SBT	SBR
Lane Configurations		↕			↕			↕			↕	
Traffic Vol, veh/h	13	35	2	0	34	4	9	7	6	3	8	12
Future Vol, veh/h	13	35	2	0	34	4	9	7	6	3	8	12
Conflicting Peds, #/hr	0	0	1	1	0	0	0	0	0	0	0	0
Sign Control	Free	Free	Free	Free	Free	Free	Stop	Stop	Stop	Stop	Stop	Stop
RT Channelized	-	-	None	-	-	None	-	-	None	-	-	None
Storage Length	-	-	-	-	-	-	-	-	-	-	-	-
Veh in Median Storage, #	-	0	-	-	0	-	-	0	-	-	0	-
Grade, %	-	0	-	-	0	-	-	0	-	-	0	-
Peak Hour Factor	79	79	79	79	79	79	79	79	79	79	79	79
Heavy Vehicles, %	0	3	0	0	0	0	0	0	0	33	0	0
Mvmt Flow	16	44	3	0	43	5	11	9	8	4	10	15

Major/Minor	Major1			Major2			Minor1			Minor2		
Conflicting Flow All	48	0	0	48	0	0	137	127	47	133	127	46
Stage 1	-	-	-	-	-	-	79	79	-	46	46	-
Stage 2	-	-	-	-	-	-	58	48	-	87	81	-
Critical Hdwy	4.1	-	-	4.1	-	-	7.1	6.5	6.2	7.43	6.5	6.2
Critical Hdwy Stg 1	-	-	-	-	-	-	6.1	5.5	-	6.43	5.5	-
Critical Hdwy Stg 2	-	-	-	-	-	-	6.1	5.5	-	6.43	5.5	-
Follow-up Hdwy	2.2	-	-	2.2	-	-	3.5	4	3.3	3.797	4	3.3
Pot Cap-1 Maneuver	1572	-	-	1572	-	-	838	767	1028	772	767	1029
Stage 1	-	-	-	-	-	-	935	833	-	895	861	-
Stage 2	-	-	-	-	-	-	959	859	-	849	832	-
Platoon blocked, %		-	-		-	-						
Mov Cap-1 Maneuver	1572	-	-	1572	-	-	810	759	1027	754	759	1029
Mov Cap-2 Maneuver	-	-	-	-	-	-	810	759	-	754	759	-
Stage 1	-	-	-	-	-	-	925	824	-	886	861	-
Stage 2	-	-	-	-	-	-	934	859	-	825	823	-

Approach	EB	WB	NB	SB
HCM Control Delay, s	1.9	0	9.4	9.2
HCM LOS			A	A

Minor Lane/Major Mvmt	NBLn1	EBL	EBT	EBR	WBL	WBT	WBR	SBLn1
Capacity (veh/h)	840	1572	-	-	1572	-	-	879
HCM Lane V/C Ratio	0.033	0.01	-	-	-	-	-	0.033
HCM Control Delay (s)	9.4	7.3	0	-	0	-	-	9.2
HCM Lane LOS	A	A	A	-	A	-	-	A
HCM 95th %tile Q(veh)	0.1	0	-	-	0	-	-	0.1

Intersection

Int Delay, s/veh 7.5

Movement	EBL	EBT	EBR	WBL	WBT	WBR	NBL	NBT	NBR	SBL	SBT	SBR
Lane Configurations		↕			↕			↕			↕	
Traffic Vol, veh/h	0	39	3	9	33	2	4	6	5	15	12	2
Future Vol, veh/h	0	39	3	9	33	2	4	6	5	15	12	2
Conflicting Peds, #/hr	3	0	0	0	0	3	3	0	2	2	0	3
Sign Control	Stop	Stop	Stop	Stop	Stop	Stop	Free	Free	Free	Free	Free	Free
RT Channelized	-	-	None	-	-	None	-	-	None	-	-	None
Storage Length	-	-	-	-	-	-	-	-	-	-	-	-
Veh in Median Storage, #	-	0	-	-	0	-	-	0	-	-	0	-
Grade, %	-	0	-	-	0	-	-	0	-	-	0	-
Peak Hour Factor	86	86	86	86	86	86	86	86	86	86	86	86
Heavy Vehicles, %	0	5	0	22	0	0	0	0	0	0	8	0
Mvmt Flow	0	45	3	10	38	2	5	7	6	17	14	2

Major/Minor	Minor2			Minor1			Major1			Major2		
Conflicting Flow All	96	77	18	95	75	15	19	0	0	15	0	0
Stage 1	53	53	-	21	21	-	-	-	-	-	-	-
Stage 2	43	24	-	74	54	-	-	-	-	-	-	-
Critical Hdwy	7.1	6.55	6.2	7.32	6.5	6.2	4.1	-	-	4.1	-	-
Critical Hdwy Stg 1	6.1	5.55	-	6.32	5.5	-	-	-	-	-	-	-
Critical Hdwy Stg 2	6.1	5.55	-	6.32	5.5	-	-	-	-	-	-	-
Follow-up Hdwy	3.5	4.045	3.3	3.698	4	3.3	2.2	-	-	2.2	-	-
Pot Cap-1 Maneuver	891	808	1066	842	819	1070	1611	-	-	1616	-	-
Stage 1	965	845	-	948	882	-	-	-	-	-	-	-
Stage 2	976	869	-	888	854	-	-	-	-	-	-	-
Platoon blocked, %												
Mov Cap-1 Maneuver	843	793	1063	793	804	1065	1611	-	-	1611	-	-
Mov Cap-2 Maneuver	843	793	-	793	804	-	-	-	-	-	-	-
Stage 1	959	833	-	943	878	-	-	-	-	-	-	-
Stage 2	926	865	-	828	842	-	-	-	-	-	-	-

Approach	EB	WB	NB	SB
HCM Control Delay, s	9.7	9.7	1.9	3.8
HCM LOS	A	A		

Minor Lane/Major Mvmt	NBL	NBT	NBR	EBLn1	WBLn1	SBL	SBT	SBR
Capacity (veh/h)	1611	-	-	808	811	1611	-	-
HCM Lane V/C Ratio	0.003	-	-	0.06	0.063	0.011	-	-
HCM Control Delay (s)	7.2	0	-	9.7	9.7	7.3	0	-
HCM Lane LOS	A	A	-	A	A	A	A	-
HCM 95th %tile Q(veh)	0	-	-	0.2	0.2	0	-	-

Intersection	
Intersection Delay, s/veh	7.3
Intersection LOS	A

Movement	EBU	EBL	EBT	EBR	WBU	WBL	WBT	WBR	NBU	NBL	NBT	NBR
Lane Configurations			↕				↕				↕	
Traffic Vol, veh/h	0	2	53	6	0	1	32	0	0	5	2	3
Future Vol, veh/h	0	2	53	6	0	1	32	0	0	5	2	3
Peak Hour Factor	0.92	0.75	0.75	0.75	0.92	0.75	0.75	0.75	0.92	0.75	0.75	0.75
Heavy Vehicles, %	2	0	4	0	2	0	0	0	2	40	0	0
Mvmt Flow	0	3	71	8	0	1	43	0	0	7	3	4
Number of Lanes	0	0	1	0	0	0	1	0	0	0	1	0

Approach	EB	WB	NB
Opposing Approach	WB	EB	SB
Opposing Lanes	1	1	1
Conflicting Approach Left	SB	NB	EB
Conflicting Lanes Left	1	1	1
Conflicting Approach Right	NB	SB	WB
Conflicting Lanes Right	1	1	1
HCM Control Delay	7.3	7.2	7.9
HCM LOS	A	A	A

Lane	NBLn1	EBLn1	WBLn1	SBLn1
Vol Left, %	50%	3%	3%	0%
Vol Thru, %	20%	87%	97%	0%
Vol Right, %	30%	10%	0%	100%
Sign Control	Stop	Stop	Stop	Stop
Traffic Vol by Lane	10	61	33	4
LT Vol	5	2	1	0
Through Vol	2	53	32	0
RT Vol	3	6	0	4
Lane Flow Rate	13	81	44	5
Geometry Grp	1	1	1	1
Degree of Util (X)	0.017	0.088	0.049	0.005
Departure Headway (Hd)	4.721	3.914	4	3.525
Convergence, Y/N	Yes	Yes	Yes	Yes
Cap	755	917	895	1006
Service Time	2.771	1.932	2.023	1.579
HCM Lane V/C Ratio	0.017	0.088	0.049	0.005
HCM Control Delay	7.9	7.3	7.2	6.6
HCM Lane LOS	A	A	A	A
HCM 95th-tile Q	0.1	0.3	0.2	0

Intersection

Intersection Delay, s/veh
 Intersection LOS

Movement	SBU	SBL	SBT	SBR
Lane Configurations			↕	
Traffic Vol, veh/h	0	0	0	4
Future Vol, veh/h	0	0	0	4
Peak Hour Factor	0.92	0.75	0.75	0.75
Heavy Vehicles, %	2	0	0	0
Mvmt Flow	0	0	0	5
Number of Lanes	0	0	1	0

Approach SB

Opposing Approach	NB
Opposing Lanes	1
Conflicting Approach Left	WB
Conflicting Lanes Left	1
Conflicting Approach Right	EB
Conflicting Lanes Right	1
HCM Control Delay	6.6
HCM LOS	A

Intersection

Int Delay, s/veh 0.1

Movement	EBL	EBR	NBL	NBT	SBT	SBR
Lane Configurations	Y			Y	Y	
Traffic Vol, veh/h	1	2	8	691	835	1
Future Vol, veh/h	1	2	8	691	835	1
Conflicting Peds, #/hr	0	0	0	0	0	0
Sign Control	Stop	Stop	Free	Free	Free	Free
RT Channelized	-	None	-	None	-	None
Storage Length	0	-	-	-	-	-
Veh in Median Storage, #	0	-	-	0	0	-
Grade, %	0	-	-	0	0	-
Peak Hour Factor	91	91	91	91	91	92
Heavy Vehicles, %	2	2	2	2	2	2
Mvmt Flow	1	2	9	759	918	1

Major/Minor	Minor2		Major1		Major2	
Conflicting Flow All	1695	918	919	0	-	0
Stage 1	918	-	-	-	-	-
Stage 2	777	-	-	-	-	-
Critical Hdwy	6.42	6.22	4.12	-	-	-
Critical Hdwy Stg 1	5.42	-	-	-	-	-
Critical Hdwy Stg 2	5.42	-	-	-	-	-
Follow-up Hdwy	3.518	3.318	2.218	-	-	-
Pot Cap-1 Maneuver	102	329	743	-	-	-
Stage 1	389	-	-	-	-	-
Stage 2	453	-	-	-	-	-
Platoon blocked, %				-	-	-
Mov Cap-1 Maneuver	100	329	743	-	-	-
Mov Cap-2 Maneuver	100	-	-	-	-	-
Stage 1	389	-	-	-	-	-
Stage 2	443	-	-	-	-	-

Approach	EB	NB	SB
HCM Control Delay, s	24.6	0.1	0
HCM LOS	C		

Minor Lane/Major Mvmt	NBL	NBT	EBLn1	SBT	SBR
Capacity (veh/h)	743	-	187	-	-
HCM Lane V/C Ratio	0.012	-	0.018	-	-
HCM Control Delay (s)	9.9	0	24.6	-	-
HCM Lane LOS	A	A	C	-	-
HCM 95th %tile Q(veh)	0	-	0.1	-	-

Intersection

Int Delay, s/veh 0.2

Movement	WBL	WBR	NBT	NBR	SBL	SBT
Lane Configurations	↘		↑	↗		↖
Traffic Vol, veh/h	7	3	741	9	4	957
Future Vol, veh/h	7	3	741	9	4	957
Conflicting Peds, #/hr	0	0	0	1	1	0
Sign Control	Stop	Stop	Free	Free	Free	Free
RT Channelized	-	None	-	None	-	None
Storage Length	0	-	-	125	-	-
Veh in Median Storage, #	0	-	0	-	-	0
Grade, %	0	-	0	-	-	0
Peak Hour Factor	96	96	96	96	96	96
Heavy Vehicles, %	0	0	2	0	0	1
Mvmt Flow	7	3	772	9	4	997

Major/Minor	Minor1		Major1		Major2	
Conflicting Flow All	1778	773	0	0	773	0
Stage 1	773	-	-	-	-	-
Stage 2	1005	-	-	-	-	-
Critical Hdwy	6.4	6.2	-	-	4.1	-
Critical Hdwy Stg 1	5.4	-	-	-	-	-
Critical Hdwy Stg 2	5.4	-	-	-	-	-
Follow-up Hdwy	3.5	3.3	-	-	2.2	-
Pot Cap-1 Maneuver	92	402	-	-	851	-
Stage 1	459	-	-	-	-	-
Stage 2	357	-	-	-	-	-
Platoon blocked, %			-	-		
Mov Cap-1 Maneuver	91	402	-	-	851	-
Mov Cap-2 Maneuver	91	-	-	-	-	-
Stage 1	459	-	-	-	-	-
Stage 2	353	-	-	-	-	-

Approach	WB		NB		SB
HCM Control Delay, s	38.1		0		0
HCM LOS	E				

Minor Lane/Major Mvmt	NBT	NBRWBLn1	SBL	SBT
Capacity (veh/h)	-	- 119	851	-
HCM Lane V/C Ratio	-	- 0.088	0.005	-
HCM Control Delay (s)	-	- 38.1	9.3	0
HCM Lane LOS	-	- E	A	A
HCM 95th %tile Q(veh)	-	- 0.3	0	-

Intersection

Int Delay, s/veh 0

Movement	EBL	EBT	EBR	WBL	WBT	WBR	NBL	NBT	NBR	SBL	SBT	SBR
Lane Configurations		↕			↕		↕	↕		↕	↕	
Traffic Vol, veh/h	0	0	0	1	0	1	2	740	0	1	966	4
Future Vol, veh/h	0	0	0	1	0	1	2	740	0	1	966	4
Conflicting Peds, #/hr	0	0	1	1	0	0	0	0	3	3	0	0
Sign Control	Stop	Stop	Stop	Stop	Stop	Stop	Free	Free	Free	Free	Free	Free
RT Channelized	-	-	None	-	-	None	-	-	None	-	-	None
Storage Length	-	-	-	-	-	-	65	-	-	50	-	-
Veh in Median Storage, #	-	0	-	-	0	-	-	0	-	-	0	-
Grade, %	-	0	-	-	0	-	-	0	-	-	0	-
Peak Hour Factor	96	96	96	96	96	96	96	96	96	96	96	96
Heavy Vehicles, %	0	0	0	0	0	0	0	3	0	0	2	0
Mvmt Flow	0	0	0	1	0	1	2	771	0	1	1006	4

Major/Minor	Minor2			Minor1			Major1			Major2		
Conflicting Flow All	1786	1788	1009	1789	1791	774	1010	0	0	774	0	0
Stage 1	1010	1010	-	778	778	-	-	-	-	-	-	-
Stage 2	776	778	-	1011	1013	-	-	-	-	-	-	-
Critical Hdwy	7.1	6.5	6.2	7.1	6.5	6.2	4.1	-	-	4.1	-	-
Critical Hdwy Stg 1	6.1	5.5	-	6.1	5.5	-	-	-	-	-	-	-
Critical Hdwy Stg 2	6.1	5.5	-	6.1	5.5	-	-	-	-	-	-	-
Follow-up Hdwy	3.5	4	3.3	3.5	4	3.3	2.2	-	-	2.2	-	-
Pot Cap-1 Maneuver	64	82	294	64	82	402	694	-	-	851	-	-
Stage 1	292	320	-	392	410	-	-	-	-	-	-	-
Stage 2	393	410	-	291	319	-	-	-	-	-	-	-
Platoon blocked, %												
Mov Cap-1 Maneuver	64	81	294	64	81	401	693	-	-	851	-	-
Mov Cap-2 Maneuver	64	81	-	64	81	-	-	-	-	-	-	-
Stage 1	291	320	-	390	408	-	-	-	-	-	-	-
Stage 2	391	408	-	290	319	-	-	-	-	-	-	-

Approach	EB	WB	NB	SB
HCM Control Delay, s	0	38.4	0	0
HCM LOS	A	E		

Minor Lane/Major Mvmt	NBL	NBT	NBR	EBLn1WBLn1	SBL	SBT	SBR
Capacity (veh/h)	693	-	-	- 110	851	-	-
HCM Lane V/C Ratio	0.003	-	-	- 0.019	0.001	-	-
HCM Control Delay (s)	10.2	-	-	0 38.4	9.2	-	-
HCM Lane LOS	B	-	-	A E	A	-	-
HCM 95th %tile Q(veh)	0	-	-	- 0.1	0	-	-

Intersection

Int Delay, s/veh 0.2

Movement	WBL	WBR	NBT	NBR	SBL	SBT
Lane Configurations	↘		↗		↘	↗
Traffic Vol, veh/h	0	11	734	0	8	958
Future Vol, veh/h	0	11	734	0	8	958
Conflicting Peds, #/hr	0	0	0	1	1	0
Sign Control	Stop	Stop	Free	Free	Free	Free
RT Channelized	-	None	-	None	-	None
Storage Length	0	-	-	-	65	-
Veh in Median Storage, #	0	-	0	-	-	0
Grade, %	0	-	0	-	-	0
Peak Hour Factor	93	93	93	93	93	93
Heavy Vehicles, %	0	9	2	0	0	1
Mvmt Flow	0	12	789	0	9	1030

Major/Minor	Minor1		Major1		Major2	
Conflicting Flow All	1837	790	0	0	790	0
Stage 1	790	-	-	-	-	-
Stage 2	1047	-	-	-	-	-
Critical Hdwy	6.4	6.29	-	-	4.1	-
Critical Hdwy Stg 1	5.4	-	-	-	-	-
Critical Hdwy Stg 2	5.4	-	-	-	-	-
Follow-up Hdwy	3.5	3.381	-	-	2.2	-
Pot Cap-1 Maneuver	84	379	-	-	839	-
Stage 1	451	-	-	-	-	-
Stage 2	341	-	-	-	-	-
Platoon blocked, %			-	-		-
Mov Cap-1 Maneuver	83	379	-	-	839	-
Mov Cap-2 Maneuver	83	-	-	-	-	-
Stage 1	451	-	-	-	-	-
Stage 2	337	-	-	-	-	-

Approach	WB		NB		SB
HCM Control Delay, s	14.8		0		0.1
HCM LOS	B				

Minor Lane/Major Mvmt	NBT	NBRWBLn1	SBL	SBT
Capacity (veh/h)	-	- 379	839	-
HCM Lane V/C Ratio	-	- 0.031	0.01	-
HCM Control Delay (s)	-	- 14.8	9.3	-
HCM Lane LOS	-	- B	A	-
HCM 95th %tile Q(veh)	-	- 0.1	0	-

Intersection

Int Delay, s/veh 6.7

Movement	WBL	WBR	NBT	NBR	SBL	SBT
Lane Configurations	Y		P			A
Traffic Vol, veh/h	3	13	1	2	6	2
Future Vol, veh/h	3	13	1	2	6	2
Conflicting Peds, #/hr	2	0	0	0	0	0
Sign Control	Stop	Stop	Free	Free	Free	Free
RT Channelized	-	None	-	None	-	None
Storage Length	0	-	-	-	-	-
Veh in Median Storage, #	0	-	0	-	-	0
Grade, %	0	-	0	-	-	0
Peak Hour Factor	75	75	75	75	75	75
Heavy Vehicles, %	33	8	0	0	0	0
Mvmt Flow	4	17	1	3	8	3

Major/Minor	Minor1		Major1		Major2	
Conflicting Flow All	24	3	0	0	4	0
Stage 1	3	-	-	-	-	-
Stage 2	21	-	-	-	-	-
Critical Hdwy	6.73	6.28	-	-	4.1	-
Critical Hdwy Stg 1	5.73	-	-	-	-	-
Critical Hdwy Stg 2	5.73	-	-	-	-	-
Follow-up Hdwy	3.797	3.372	-	-	2.2	-
Pot Cap-1 Maneuver	918	1064	-	-	1631	-
Stage 1	945	-	-	-	-	-
Stage 2	927	-	-	-	-	-
Platoon blocked, %			-	-		-
Mov Cap-1 Maneuver	912	1064	-	-	1631	-
Mov Cap-2 Maneuver	912	-	-	-	-	-
Stage 1	945	-	-	-	-	-
Stage 2	921	-	-	-	-	-

Approach	WB		NB		SB
HCM Control Delay, s	8.6		0		5.4
HCM LOS	A				

Minor Lane/Major Mvmt	NBT	NBRWBLn1	SBL	SBT
Capacity (veh/h)	-	- 1032	1631	-
HCM Lane V/C Ratio	-	- 0.021	0.005	-
HCM Control Delay (s)	-	- 8.6	7.2	0
HCM Lane LOS	-	- A	A	A
HCM 95th %tile Q(veh)	-	- 0.1	0	-

Intersection

Int Delay, s/veh 5.9

Movement	EBT	EBR	WBL	WBT	NBL	NBR
Lane Configurations	↔			↔	↔	
Traffic Vol, veh/h	2	5	1	0	13	1
Future Vol, veh/h	2	5	1	0	13	1
Conflicting Peds, #/hr	0	1	1	0	0	0
Sign Control	Free	Free	Free	Free	Stop	Stop
RT Channelized	-	None	-	None	-	None
Storage Length	-	-	-	-	0	-
Veh in Median Storage, #	0	-	-	0	0	-
Grade, %	0	-	-	0	0	-
Peak Hour Factor	79	79	79	79	79	79
Heavy Vehicles, %	0	0	100	0	15	0
Mvmt Flow	3	6	1	0	16	1

Major/Minor	Major1	Major2	Minor1
Conflicting Flow All	0	10	10
Stage 1	-	-	7
Stage 2	-	-	3
Critical Hdwy	-	5.1	6.55
Critical Hdwy Stg 1	-	-	5.55
Critical Hdwy Stg 2	-	-	5.55
Follow-up Hdwy	-	3.1	3.635
Pot Cap-1 Maneuver	-	1150	977
Stage 1	-	-	983
Stage 2	-	-	987
Platoon blocked, %	-	-	-
Mov Cap-1 Maneuver	-	1150	975
Mov Cap-2 Maneuver	-	-	975
Stage 1	-	-	982
Stage 2	-	-	986

Approach	EB	WB	NB
HCM Control Delay, s	0	8.1	8.7
HCM LOS			A

Minor Lane/Major Mvmt	NBLn1	EBT	EBR	WBL	WBT
Capacity (veh/h)	982	-	-	1150	-
HCM Lane V/C Ratio	0.018	-	-	0.001	-
HCM Control Delay (s)	8.7	-	-	8.1	0
HCM Lane LOS	A	-	-	A	A
HCM 95th %tile Q(veh)	0.1	-	-	0	-

Intersection												
Int Delay, s/veh	0.8											
Movement	EBL	EBT	EBR	WBL	WBT	WBR	NBL	NBT	NBR	SBL	SBT	SBR
Lane Configurations		↔			↔		↑	↑		↑	↑	
Traffic Vol, veh/h	0	0	6	6	1	25	9	713	2	22	928	5
Future Vol, veh/h	0	0	6	6	1	25	9	713	2	22	928	5
Conflicting Peds, #/hr	0	0	0	0	0	0	0	0	1	1	0	0
Sign Control	Stop	Stop	Stop	Stop	Stop	Stop	Free	Free	Free	Free	Free	Free
RT Channelized	-	-	None	-	-	None	-	-	None	-	-	None
Storage Length	-	-	-	-	-	-	125	-	-	125	-	-
Veh in Median Storage, #	-	0	-	-	0	-	-	0	-	-	0	-
Grade, %	-	0	-	-	0	-	-	0	-	-	0	-
Peak Hour Factor	95	95	95	95	95	95	95	95	95	95	95	95
Heavy Vehicles, %	0	0	0	17	0	4	0	3	0	5	1	0
Mvmt Flow	0	0	6	6	1	26	9	751	2	23	977	5

Major/Minor	Minor2			Minor1			Major1			Major2		
Conflicting Flow All	1810	1799	979	1801	1800	753	982	0	0	754	0	0
Stage 1	1026	1026	-	772	772	-	-	-	-	-	-	-
Stage 2	784	773	-	1029	1028	-	-	-	-	-	-	-
Critical Hdwy	7.1	6.5	6.2	7.27	6.5	6.24	4.1	-	-	4.15	-	-
Critical Hdwy Stg 1	6.1	5.5	-	6.27	5.5	-	-	-	-	-	-	-
Critical Hdwy Stg 2	6.1	5.5	-	6.27	5.5	-	-	-	-	-	-	-
Follow-up Hdwy	3.5	4	3.3	3.653	4	3.336	2.2	-	-	2.245	-	-
Pot Cap-1 Maneuver	62	81	306	57	81	406	711	-	-	843	-	-
Stage 1	286	315	-	370	412	-	-	-	-	-	-	-
Stage 2	389	412	-	265	314	-	-	-	-	-	-	-
Platoon blocked, %												
Mov Cap-1 Maneuver	56	78	306	54	78	406	711	-	-	843	-	-
Mov Cap-2 Maneuver	56	78	-	54	78	-	-	-	-	-	-	-
Stage 1	282	306	-	365	406	-	-	-	-	-	-	-
Stage 2	358	406	-	252	305	-	-	-	-	-	-	-

Approach	EB	WB	NB	SB
HCM Control Delay, s	17	31	0.1	0.2
HCM LOS	C	D		

Minor Lane/Major Mvmt	NBL	NBT	NBR	EBLn1WBLn1	SBL	SBT	SBR
Capacity (veh/h)	711	-	-	306	172	843	-
HCM Lane V/C Ratio	0.013	-	-	0.021	0.196	0.027	-
HCM Control Delay (s)	10.1	-	-	17	31	9.4	-
HCM Lane LOS	B	-	-	C	D	A	-
HCM 95th %tile Q(veh)	0	-	-	0.1	0.7	0.1	-

Intersection

Int Delay, s/veh 3.3

Movement	EBL	EBT	EBR	WBL	WBT	WBR	NBL	NBT	NBR	SBL	SBT	SBR
Lane Configurations		↔			↔		↔	↔		↔	↔	
Traffic Vol, veh/h	6	3	21	23	3	23	28	697	36	7	928	7
Future Vol, veh/h	6	3	21	23	3	23	28	697	36	7	928	7
Conflicting Peds, #/hr	1	0	0	0	0	1	0	0	0	0	0	0
Sign Control	Stop	Stop	Stop	Stop	Stop	Stop	Free	Free	Free	Free	Free	Free
RT Channelized	-	-	None	-	-	None	-	-	None	-	-	None
Storage Length	-	-	-	-	-	-	80	-	-	125	-	-
Veh in Median Storage, #	-	0	-	-	0	-	-	0	-	-	0	-
Grade, %	-	0	-	-	0	-	-	0	-	-	0	-
Peak Hour Factor	95	95	95	95	95	95	95	95	95	95	95	95
Heavy Vehicles, %	2	2	2	2	2	2	2	2	2	2	2	2
Mvmt Flow	6	3	22	24	3	24	29	734	38	7	977	7

Major/Minor	Minor2			Minor1			Major1			Major2		
Conflicting Flow All	1821	1826	981	1820	1811	754	984	0	0	772	0	0
Stage 1	995	995	-	812	812	-	-	-	-	-	-	-
Stage 2	826	831	-	1008	999	-	-	-	-	-	-	-
Critical Hdwy	7.12	6.52	6.22	7.12	6.52	6.22	4.12	-	-	4.12	-	-
Critical Hdwy Stg 1	6.12	5.52	-	6.12	5.52	-	-	-	-	-	-	-
Critical Hdwy Stg 2	6.12	5.52	-	6.12	5.52	-	-	-	-	-	-	-
Follow-up Hdwy	3.518	4.018	3.318	3.518	4.018	3.318	2.218	-	-	2.218	-	-
Pot Cap-1 Maneuver	60	77	303	60	79	409	702	-	-	843	-	-
Stage 1	295	323	-	373	392	-	-	-	-	-	-	-
Stage 2	366	384	-	290	321	-	-	-	-	-	-	-
Platoon blocked, %												
Mov Cap-1 Maneuver	53	73	303	52	75	409	702	-	-	842	-	-
Mov Cap-2 Maneuver	53	73	-	52	75	-	-	-	-	-	-	-
Stage 1	283	320	-	358	376	-	-	-	-	-	-	-
Stage 2	327	368	-	264	318	-	-	-	-	-	-	-

Approach	EB	WB	NB	SB
HCM Control Delay, s	40	87.1	0.4	0.1
HCM LOS	E	F		

Minor Lane/Major Mvmt	NBL	NBT	NBR	EBLn1	WBLn1	SBL	SBT	SBR
Capacity (veh/h)	702	-	-	134	91	842	-	-
HCM Lane V/C Ratio	0.042	-	-	0.236	0.567	0.009	-	-
HCM Control Delay (s)	10.4	-	-	40	87.1	9.3	-	-
HCM Lane LOS	B	-	-	E	F	A	-	-
HCM 95th %tile Q(veh)	0.1	-	-	0.9	2.6	0	-	-

Intersection

Int Delay, s/veh 4.5

Movement	EBL	EBT	EBR	WBL	WBT	WBR	NBL	NBT	NBR	SBL	SBT	SBR
Lane Configurations		↕			↕			↕			↕	
Traffic Vol, veh/h	25	33	2	5	31	17	10	9	3	6	17	8
Future Vol, veh/h	25	33	2	5	31	17	10	9	3	6	17	8
Conflicting Peds, #/hr	1	0	0	0	0	1	0	0	2	2	0	0
Sign Control	Free	Free	Free	Free	Free	Free	Stop	Stop	Stop	Stop	Stop	Stop
RT Channelized	-	-	None	-	-	None	-	-	None	-	-	None
Storage Length	-	-	-	-	-	-	-	-	-	-	-	-
Veh in Median Storage, #	-	0	-	-	0	-	-	0	-	-	0	-
Grade, %	-	0	-	-	0	-	-	0	-	-	0	-
Peak Hour Factor	83	83	83	83	83	83	83	83	83	83	83	83
Heavy Vehicles, %	0	0	0	0	0	0	0	0	0	0	0	0
Mvmt Flow	30	40	2	6	37	20	12	11	4	7	20	10

Major/Minor	Major1	Major2	Minor1	Minor2								
Conflicting Flow All	59	0	0	42	0	0	176	172	43	171	163	49
Stage 1	-	-	-	-	-	-	101	101	-	61	61	-
Stage 2	-	-	-	-	-	-	75	71	-	110	102	-
Critical Hdwy	4.1	-	-	4.1	-	-	7.1	6.5	6.2	7.1	6.5	6.2
Critical Hdwy Stg 1	-	-	-	-	-	-	6.1	5.5	-	6.1	5.5	-
Critical Hdwy Stg 2	-	-	-	-	-	-	6.1	5.5	-	6.1	5.5	-
Follow-up Hdwy	2.2	-	-	2.2	-	-	3.5	4	3.3	3.5	4	3.3
Pot Cap-1 Maneuver	1558	-	-	1580	-	-	791	725	1033	797	733	1025
Stage 1	-	-	-	-	-	-	910	815	-	955	848	-
Stage 2	-	-	-	-	-	-	939	840	-	900	815	-
Platoon blocked, %	-	-	-	-	-	-	-	-	-	-	-	-
Mov Cap-1 Maneuver	1558	-	-	1577	-	-	752	707	1031	768	715	1024
Mov Cap-2 Maneuver	-	-	-	-	-	-	752	707	-	768	715	-
Stage 1	-	-	-	-	-	-	892	799	-	935	844	-
Stage 2	-	-	-	-	-	-	904	836	-	865	799	-

Approach	EB	WB	NB	SB
HCM Control Delay, s	3.1	0.7	9.9	9.8
HCM LOS			A	A

Minor Lane/Major Mvmt	NBLn1	EBL	EBT	EBR	WBL	WBT	WBR	SBLn1
Capacity (veh/h)	760	1558	-	-	1577	-	-	787
HCM Lane V/C Ratio	0.035	0.019	-	-	0.004	-	-	0.047
HCM Control Delay (s)	9.9	7.4	0	-	7.3	0	-	9.8
HCM Lane LOS	A	A	A	-	A	A	-	A
HCM 95th %tile Q(veh)	0.1	0.1	-	-	0	-	-	0.1

Intersection

Int Delay, s/veh 6.9

Movement	EBL	EBT	EBR	WBL	WBT	WBR	NBL	NBT	NBR	SBL	SBT	SBR
Lane Configurations		↕			↕			↕			↕	
Traffic Vol, veh/h	2	37	3	10	37	2	7	13	7	8	16	3
Future Vol, veh/h	2	37	3	10	37	2	7	13	7	8	16	3
Conflicting Peds, #/hr	4	0	0	0	0	4	1	0	1	1	0	1
Sign Control	Stop	Stop	Stop	Stop	Stop	Stop	Free	Free	Free	Free	Free	Free
RT Channelized	-	-	None	-	-	None	-	-	None	-	-	None
Storage Length	-	-	-	-	-	-	-	-	-	-	-	-
Veh in Median Storage, #	-	0	-	-	0	-	-	0	-	-	0	-
Grade, %	-	0	-	-	0	-	-	0	-	-	0	-
Peak Hour Factor	84	84	84	84	84	84	84	84	84	84	84	84
Heavy Vehicles, %	0	0	0	0	0	0	0	8	14	0	6	0
Mvmt Flow	2	44	4	12	44	2	8	15	8	10	19	4

Major/Minor	Minor2			Minor1			Major1			Major2		
Conflicting Flow All	105	82	22	101	80	25	24	0	0	25	0	0
Stage 1	41	41	-	37	37	-	-	-	-	-	-	-
Stage 2	64	41	-	64	43	-	-	-	-	-	-	-
Critical Hdwy	7.1	6.5	6.2	7.1	6.5	6.2	4.1	-	-	4.1	-	-
Critical Hdwy Stg 1	6.1	5.5	-	6.1	5.5	-	-	-	-	-	-	-
Critical Hdwy Stg 2	6.1	5.5	-	6.1	5.5	-	-	-	-	-	-	-
Follow-up Hdwy	3.5	4	3.3	3.5	4	3.3	2.2	-	-	2.2	-	-
Pot Cap-1 Maneuver	880	812	1061	885	814	1057	1604	-	-	1603	-	-
Stage 1	979	865	-	984	868	-	-	-	-	-	-	-
Stage 2	952	865	-	952	863	-	-	-	-	-	-	-
Platoon blocked, %												
Mov Cap-1 Maneuver	830	802	1060	837	804	1052	1604	-	-	1597	-	-
Mov Cap-2 Maneuver	830	802	-	837	804	-	-	-	-	-	-	-
Stage 1	973	859	-	978	863	-	-	-	-	-	-	-
Stage 2	893	860	-	895	857	-	-	-	-	-	-	-

Approach	EB	WB	NB	SB
HCM Control Delay, s	9.7	9.7	1.9	2.2
HCM LOS	A	A		

Minor Lane/Major Mvmt	NBL	NBT	NBR	EBLn1	WBLn1	SBL	SBT	SBR
Capacity (veh/h)	1604	-	-	818	818	1597	-	-
HCM Lane V/C Ratio	0.005	-	-	0.061	0.071	0.006	-	-
HCM Control Delay (s)	7.3	0	-	9.7	9.7	7.3	0	-
HCM Lane LOS	A	A	-	A	A	A	A	-
HCM 95th %tile Q(veh)	0	-	-	0.2	0.2	0	-	-

Intersection	
Intersection Delay, s/veh	7.2
Intersection LOS	A

Movement	EBU	EBL	EBT	EBR	WBU	WBL	WBT	WBR	NBU	NBL	NBT	NBR
Lane Configurations			↕				↕				↕	
Traffic Vol, veh/h	0	4	45	3	0	2	40	0	0	4	1	4
Future Vol, veh/h	0	4	45	3	0	2	40	0	0	4	1	4
Peak Hour Factor	0.92	0.83	0.83	0.83	0.92	0.83	0.83	0.83	0.92	0.83	0.83	0.83
Heavy Vehicles, %	2	0	2	0	2	0	0	0	2	0	0	0
Mvmt Flow	0	5	54	4	0	2	48	0	0	5	1	5
Number of Lanes	0	0	1	0	0	0	1	0	0	0	1	0

Approach	EB	WB	NB
Opposing Approach	WB	EB	SB
Opposing Lanes	1	1	1
Conflicting Approach Left	SB	NB	EB
Conflicting Lanes Left	1	1	1
Conflicting Approach Right	NB	SB	WB
Conflicting Lanes Right	1	1	1
HCM Control Delay	7.3	7.2	7
HCM LOS	A	A	A

Lane	NBLn1	EBLn1	WBLn1	SBLn1
Vol Left, %	44%	8%	5%	0%
Vol Thru, %	11%	87%	95%	14%
Vol Right, %	44%	6%	0%	86%
Sign Control	Stop	Stop	Stop	Stop
Traffic Vol by Lane	9	52	42	7
LT Vol	4	4	2	0
Through Vol	1	45	40	1
RT Vol	4	3	0	6
Lane Flow Rate	11	63	51	8
Geometry Grp	1	1	1	1
Degree of Util (X)	0.012	0.069	0.056	0.008
Departure Headway (Hd)	3.924	3.952	3.99	3.59
Convergence, Y/N	Yes	Yes	Yes	Yes
Cap	907	908	899	990
Service Time	1.971	1.967	2.007	1.638
HCM Lane V/C Ratio	0.012	0.069	0.057	0.008
HCM Control Delay	7	7.3	7.2	6.7
HCM Lane LOS	A	A	A	A
HCM 95th-tile Q	0	0.2	0.2	0

Intersection

Intersection Delay, s/veh
 Intersection LOS

Movement	SBU	SBL	SBT	SBR
Lane Configurations			↔	
Traffic Vol, veh/h	0	0	1	6
Future Vol, veh/h	0	0	1	6
Peak Hour Factor	0.92	0.83	0.83	0.83
Heavy Vehicles, %	2	0	0	0
Mvmt Flow	0	0	1	7
Number of Lanes	0	0	1	0

Approach	SB
Opposing Approach	NB
Opposing Lanes	1
Conflicting Approach Left	WB
Conflicting Lanes Left	1
Conflicting Approach Right	EB
Conflicting Lanes Right	1
HCM Control Delay	6.7
HCM LOS	A

Intersection

Int Delay, s/veh 0.2

Movement	EBL	EBR	NBL	NBT	SBT	SBR
Lane Configurations	Y			Y	Y	
Traffic Vol, veh/h	3	8	4	724	935	5
Future Vol, veh/h	3	8	4	724	935	5
Conflicting Peds, #/hr	0	0	1	0	0	1
Sign Control	Stop	Stop	Free	Free	Free	Free
RT Channelized	-	None	-	None	-	None
Storage Length	0	-	-	-	-	-
Veh in Median Storage, #	0	-	-	0	0	-
Grade, %	0	-	-	0	0	-
Peak Hour Factor	95	95	95	95	95	95
Heavy Vehicles, %	2	2	2	2	2	2
Mvmt Flow	3	8	4	762	984	5

Major/Minor	Minor2		Major1		Major2	
Conflicting Flow All	1759	988	990	0	-	0
Stage 1	988	-	-	-	-	-
Stage 2	771	-	-	-	-	-
Critical Hdwy	6.42	6.22	4.12	-	-	-
Critical Hdwy Stg 1	5.42	-	-	-	-	-
Critical Hdwy Stg 2	5.42	-	-	-	-	-
Follow-up Hdwy	3.518	3.318	2.218	-	-	-
Pot Cap-1 Maneuver	93	300	698	-	-	-
Stage 1	361	-	-	-	-	-
Stage 2	456	-	-	-	-	-
Platoon blocked, %				-	-	-
Mov Cap-1 Maneuver	92	300	698	-	-	-
Mov Cap-2 Maneuver	92	-	-	-	-	-
Stage 1	361	-	-	-	-	-
Stage 2	451	-	-	-	-	-

Approach	EB	NB	SB
HCM Control Delay, s	25.6	0.1	0
HCM LOS	D		

Minor Lane/Major Mvmt	NBL	NBT	EBLn1	SBT	SBR
Capacity (veh/h)	698	-	186	-	-
HCM Lane V/C Ratio	0.006	-	0.062	-	-
HCM Control Delay (s)	10.2	0	25.6	-	-
HCM Lane LOS	B	A	D	-	-
HCM 95th %tile Q(veh)	0	-	0.2	-	-

APPENDIX 4. EXISTING WITH PROJECT OPERATIONS RESULTS

Intersection

Int Delay, s/veh 0.4

Movement	WBL	WBR	NBT	NBR	SBL	SBT
Lane Configurations	↕		↑	↗		↖
Traffic Vol, veh/h	14	7	694	15	1	571
Future Vol, veh/h	14	7	694	15	1	571
Conflicting Peds, #/hr	0	0	0	0	0	0
Sign Control	Stop	Stop	Free	Free	Free	Free
RT Channelized	-	None	-	None	-	None
Storage Length	0	-	-	125	-	-
Veh in Median Storage, #	0	-	0	-	-	0
Grade, %	0	-	0	-	-	0
Peak Hour Factor	92	92	92	92	92	92
Heavy Vehicles, %	0	0	6	0	0	4
Mvmt Flow	15	8	754	16	1	621

Major/Minor	Minor1		Major1		Major2	
Conflicting Flow All	1377	754	0	0	754	0
Stage 1	754	-	-	-	-	-
Stage 2	623	-	-	-	-	-
Critical Hdwy	6.4	6.2	-	-	4.1	-
Critical Hdwy Stg 1	5.4	-	-	-	-	-
Critical Hdwy Stg 2	5.4	-	-	-	-	-
Follow-up Hdwy	3.5	3.3	-	-	2.2	-
Pot Cap-1 Maneuver	161	412	-	-	865	-
Stage 1	468	-	-	-	-	-
Stage 2	539	-	-	-	-	-
Platoon blocked, %			-	-		
Mov Cap-1 Maneuver	161	412	-	-	865	-
Mov Cap-2 Maneuver	161	-	-	-	-	-
Stage 1	468	-	-	-	-	-
Stage 2	538	-	-	-	-	-

Approach	WB		NB		SB
HCM Control Delay, s	25.1		0		0
HCM LOS	D				

Minor Lane/Major Mvmt	NBT	NBRWBLn1	SBL	SBT
Capacity (veh/h)	-	- 202	865	-
HCM Lane V/C Ratio	-	- 0.113	0.001	-
HCM Control Delay (s)	-	- 25.1	9.2	0
HCM Lane LOS	-	- D	A	A
HCM 95th %tile Q(veh)	-	- 0.4	0	-

Intersection

Int Delay, s/veh 0.1

Movement	EBL	EBT	EBR	WBL	WBT	WBR	NBL	NBT	NBR	SBL	SBT	SBR
Lane Configurations		↔			↔		↖	↗		↖	↗	
Traffic Vol, veh/h	4	0	1	0	0	0	0	699	0	0	597	4
Future Vol, veh/h	4	0	1	0	0	0	0	699	0	0	597	4
Conflicting Peds, #/hr	1	0	0	0	0	1	1	0	1	1	0	1
Sign Control	Stop	Stop	Stop	Stop	Stop	Stop	Free	Free	Free	Free	Free	Free
RT Channelized	-	-	None	-	-	None	-	-	None	-	-	None
Storage Length	-	-	-	-	-	-	65	-	-	50	-	-
Veh in Median Storage, #	-	0	-	-	0	-	-	0	-	-	0	-
Grade, %	-	0	-	-	0	-	-	0	-	-	0	-
Peak Hour Factor	93	93	93	93	93	93	93	93	93	93	93	93
Heavy Vehicles, %	0	0	0	0	0	0	0	6	0	0	4	0
Mvmt Flow	4	0	1	0	0	0	0	752	0	0	642	4

Major/Minor	Minor2			Minor1			Major1			Major2		
Conflicting Flow All	1398	1398	645	1398	1400	754	647	0	0	753	0	0
Stage 1	645	645	-	753	753	-	-	-	-	-	-	-
Stage 2	753	753	-	645	647	-	-	-	-	-	-	-
Critical Hdwy	7.1	6.5	6.2	7.1	6.5	6.2	4.1	-	-	4.1	-	-
Critical Hdwy Stg 1	6.1	5.5	-	6.1	5.5	-	-	-	-	-	-	-
Critical Hdwy Stg 2	6.1	5.5	-	6.1	5.5	-	-	-	-	-	-	-
Follow-up Hdwy	3.5	4	3.3	3.5	4	3.3	2.2	-	-	2.2	-	-
Pot Cap-1 Maneuver	119	142	476	119	142	412	948	-	-	866	-	-
Stage 1	464	471	-	405	420	-	-	-	-	-	-	-
Stage 2	405	420	-	464	470	-	-	-	-	-	-	-
Platoon blocked, %												
Mov Cap-1 Maneuver	119	142	476	119	142	411	948	-	-	865	-	-
Mov Cap-2 Maneuver	119	142	-	119	142	-	-	-	-	-	-	-
Stage 1	464	471	-	405	420	-	-	-	-	-	-	-
Stage 2	405	420	-	463	470	-	-	-	-	-	-	-

Approach	EB	WB	NB	SB
HCM Control Delay, s	31.7	0	0	0
HCM LOS	D	A		

Minor Lane/Major Mvmt	NBL	NBT	NBR	EBLn1WBLn1	SBL	SBT	SBR
Capacity (veh/h)	948	-	-	140	-	865	-
HCM Lane V/C Ratio	-	-	-	0.038	-	-	-
HCM Control Delay (s)	0	-	-	31.7	0	0	-
HCM Lane LOS	A	-	-	D	A	A	-
HCM 95th %tile Q(veh)	0	-	-	0.1	-	0	-

Intersection

Int Delay, s/veh 0.8

Movement	WBL	WBR	NBT	NBR	SBL	SBT
Lane Configurations	↘↙		↘		↘	↗
Traffic Vol, veh/h	14	38	658	4	9	582
Future Vol, veh/h	14	38	658	4	9	582
Conflicting Peds, #/hr	0	0	0	0	0	0
Sign Control	Stop	Stop	Free	Free	Free	Free
RT Channelized	-	None	-	None	-	None
Storage Length	0	-	-	-	65	-
Veh in Median Storage, #	0	-	0	-	-	0
Grade, %	0	-	0	-	-	0
Peak Hour Factor	92	92	92	92	92	92
Heavy Vehicles, %	0	0	6	0	0	4
Mvmt Flow	15	41	715	4	10	633

Major/Minor	Minor1		Major1		Major2	
Conflicting Flow All	1369	717	0	0	720	0
Stage 1	717	-	-	-	-	-
Stage 2	652	-	-	-	-	-
Critical Hdwy	6.4	6.2	-	-	4.1	-
Critical Hdwy Stg 1	5.4	-	-	-	-	-
Critical Hdwy Stg 2	5.4	-	-	-	-	-
Follow-up Hdwy	3.5	3.3	-	-	2.2	-
Pot Cap-1 Maneuver	163	433	-	-	891	-
Stage 1	487	-	-	-	-	-
Stage 2	522	-	-	-	-	-
Platoon blocked, %			-	-		-
Mov Cap-1 Maneuver	161	433	-	-	891	-
Mov Cap-2 Maneuver	161	-	-	-	-	-
Stage 1	487	-	-	-	-	-
Stage 2	516	-	-	-	-	-

Approach	WB		NB		SB
HCM Control Delay, s	19.9		0		0.1
HCM LOS	C				

Minor Lane/Major Mvmt	NBT	NBRWBLn1	SBL	SBT
Capacity (veh/h)	-	- 298	891	-
HCM Lane V/C Ratio	-	- 0.19	0.011	-
HCM Control Delay (s)	-	- 19.9	9.1	-
HCM Lane LOS	-	- C	A	-
HCM 95th %tile Q(veh)	-	- 0.7	0	-

Intersection						
Int Delay, s/veh	7.6					
Movement	WBL	WBR	NBT	NBR	SBL	SBT
Lane Configurations	Y		P			A
Traffic Vol, veh/h	1	22	1	0	5	1
Future Vol, veh/h	1	22	1	0	5	1
Conflicting Peds, #/hr	0	0	0	0	0	0
Sign Control	Stop	Stop	Free	Free	Free	Free
RT Channelized	-	None	-	None	-	None
Storage Length	0	-	-	-	-	-
Veh in Median Storage, #	0	-	0	-	-	0
Grade, %	0	-	0	-	-	0
Peak Hour Factor	75	75	75	75	75	75
Heavy Vehicles, %	0	0	0	0	0	0
Mvmt Flow	1	29	1	0	7	1
Major/Minor	Minor1	Major1		Major2		
Conflicting Flow All	16	1	0	0	1	0
Stage 1	1	-	-	-	-	-
Stage 2	15	-	-	-	-	-
Critical Hdwy	6.4	6.2	-	-	4.1	-
Critical Hdwy Stg 1	5.4	-	-	-	-	-
Critical Hdwy Stg 2	5.4	-	-	-	-	-
Follow-up Hdwy	3.5	3.3	-	-	2.2	-
Pot Cap-1 Maneuver	1008	1090	-	-	1635	-
Stage 1	1028	-	-	-	-	-
Stage 2	1013	-	-	-	-	-
Platoon blocked, %			-	-		-
Mov Cap-1 Maneuver	1004	1090	-	-	1635	-
Mov Cap-2 Maneuver	1004	-	-	-	-	-
Stage 1	1028	-	-	-	-	-
Stage 2	1009	-	-	-	-	-
Approach	WB	NB		SB		
HCM Control Delay, s	8.4	0		6		
HCM LOS	A					
Minor Lane/Major Mvmt	NBT	NBRWBLn1	SBL	SBT		
Capacity (veh/h)	-	- 1086	1635	-		
HCM Lane V/C Ratio	-	- 0.028	0.004	-		
HCM Control Delay (s)	-	- 8.4	7.2	0		
HCM Lane LOS	-	- A	A	A		
HCM 95th %tile Q(veh)	-	- 0.1	0	-		

Intersection

Int Delay, s/veh 5.7

Movement	EBT	EBR	WBL	WBT	NBL	NBR
Lane Configurations	↔		↔		↔	
Traffic Vol, veh/h	2	3	0	4	18	0
Future Vol, veh/h	2	3	0	4	18	0
Conflicting Peds, #/hr	0	0	0	0	0	1
Sign Control	Free	Free	Free	Free	Stop	Stop
RT Channelized	-	None	-	None	-	None
Storage Length	-	-	-	-	0	-
Veh in Median Storage, #	0	-	-	0	0	-
Grade, %	0	-	-	0	0	-
Peak Hour Factor	70	70	70	70	70	70
Heavy Vehicles, %	0	0	0	0	0	0
Mvmt Flow	3	4	0	6	26	0

Major/Minor	Major1		Major2		Minor1	
Conflicting Flow All	0	0	7	0	11	6
Stage 1	-	-	-	-	5	-
Stage 2	-	-	-	-	6	-
Critical Hdwy	-	-	4.1	-	6.4	6.2
Critical Hdwy Stg 1	-	-	-	-	5.4	-
Critical Hdwy Stg 2	-	-	-	-	5.4	-
Follow-up Hdwy	-	-	2.2	-	3.5	3.3
Pot Cap-1 Maneuver	-	-	1627	-	1014	1083
Stage 1	-	-	-	-	1023	-
Stage 2	-	-	-	-	1022	-
Platoon blocked, %	-	-	-	-	-	-
Mov Cap-1 Maneuver	-	-	1625	-	1014	1082
Mov Cap-2 Maneuver	-	-	-	-	1014	-
Stage 1	-	-	-	-	1023	-
Stage 2	-	-	-	-	1022	-

Approach	EB	WB	NB
HCM Control Delay, s	0	0	8.6
HCM LOS			A

Minor Lane/Major Mvmt	NBLn1	EBT	EBR	WBL	WBT
Capacity (veh/h)	1014	-	-	1625	-
HCM Lane V/C Ratio	0.025	-	-	-	-
HCM Control Delay (s)	8.6	-	-	0	-
HCM Lane LOS	A	-	-	A	-
HCM 95th %tile Q(veh)	0.1	-	-	0	-

Intersection

Int Delay, s/veh 0.6

Movement	EBL	EBT	EBR	WBL	WBT	WBR	NBL	NBT	NBR	SBL	SBT	SBR
Lane Configurations		↔			↔		↖	↗		↖	↗	
Traffic Vol, veh/h	3	0	5	2	0	26	4	635	4	10	579	0
Future Vol, veh/h	3	0	5	2	0	26	4	635	4	10	579	0
Conflicting Peds, #/hr	0	0	0	0	0	0	1	0	0	0	0	1
Sign Control	Stop	Stop	Stop	Stop	Stop	Stop	Free	Free	Free	Free	Free	Free
RT Channelized	-	-	None	-	-	None	-	-	None	-	-	None
Storage Length	-	-	-	-	-	-	125	-	-	125	-	-
Veh in Median Storage, #	-	0	-	-	0	-	-	0	-	-	0	-
Grade, %	-	0	-	-	0	-	-	0	-	-	0	-
Peak Hour Factor	90	90	90	90	90	90	90	90	90	90	90	90
Heavy Vehicles, %	0	0	0	0	0	4	0	6	0	0	4	0
Mvmt Flow	3	0	6	2	0	29	4	706	4	11	643	0

Major/Minor	Minor2			Minor1			Major1			Major2		
Conflicting Flow All	1398	1386	644	1385	1384	708	644	0	0	710	0	0
Stage 1	667	667	-	717	717	-	-	-	-	-	-	-
Stage 2	731	719	-	668	667	-	-	-	-	-	-	-
Critical Hdwy	7.1	6.5	6.2	7.1	6.5	6.24	4.1	-	-	4.1	-	-
Critical Hdwy Stg 1	6.1	5.5	-	6.1	5.5	-	-	-	-	-	-	-
Critical Hdwy Stg 2	6.1	5.5	-	6.1	5.5	-	-	-	-	-	-	-
Follow-up Hdwy	3.5	4	3.3	3.5	4	3.336	2.2	-	-	2.2	-	-
Pot Cap-1 Maneuver	119	144	476	122	145	431	951	-	-	899	-	-
Stage 1	451	460	-	424	437	-	-	-	-	-	-	-
Stage 2	416	436	-	451	460	-	-	-	-	-	-	-
Platoon blocked, %												
Mov Cap-1 Maneuver	110	142	476	119	142	431	951	-	-	899	-	-
Mov Cap-2 Maneuver	110	142	-	119	142	-	-	-	-	-	-	-
Stage 1	449	454	-	422	435	-	-	-	-	-	-	-
Stage 2	386	434	-	440	454	-	-	-	-	-	-	-

Approach	EB	WB	NB	SB
HCM Control Delay, s	22.7	15.8	0.1	0.2
HCM LOS	C	C		

Minor Lane/Major Mvmt	NBL	NBT	NBR	EBLn1WBLn1	SBL	SBT	SBR
Capacity (veh/h)	951	-	-	212 363	899	-	-
HCM Lane V/C Ratio	0.005	-	-	0.042 0.086	0.012	-	-
HCM Control Delay (s)	8.8	-	-	22.7 15.8	9.1	-	-
HCM Lane LOS	A	-	-	C C	A	-	-
HCM 95th %tile Q(veh)	0	-	-	0.1 0.3	0	-	-

Intersection

Int Delay, s/veh 2.7

Movement	EBL	EBT	EBR	WBL	WBT	WBR	NBL	NBT	NBR	SBL	SBT	SBR
Lane Configurations		↔			↔		↔	↔		↔	↔	
Traffic Vol, veh/h	10	0	11	48	0	15	4	623	21	6	575	6
Future Vol, veh/h	10	0	11	48	0	15	4	623	21	6	575	6
Conflicting Peds, #/hr	0	0	0	0	0	0	1	0	0	0	0	1
Sign Control	Stop	Stop	Stop	Stop	Stop	Stop	Free	Free	Free	Free	Free	Free
RT Channelized	-	-	None	-	-	None	-	-	None	-	-	None
Storage Length	-	-	-	-	-	-	80	-	-	125	-	-
Veh in Median Storage, #	-	0	-	-	0	-	-	0	-	-	0	-
Grade, %	-	0	-	-	0	-	-	0	-	-	0	-
Peak Hour Factor	93	93	93	93	93	93	93	93	93	93	93	93
Heavy Vehicles, %	2	2	2	2	2	2	2	2	2	2	2	2
Mvmt Flow	11	0	12	52	0	16	4	670	23	6	618	6

Major/Minor	Minor2			Minor1			Major1			Major2		
Conflicting Flow All	1333	1336	623	1330	1329	681	626	0	0	692	0	0
Stage 1	635	635	-	690	690	-	-	-	-	-	-	-
Stage 2	698	701	-	640	639	-	-	-	-	-	-	-
Critical Hdwy	7.12	6.52	6.22	7.12	6.52	6.22	4.12	-	-	4.12	-	-
Critical Hdwy Stg 1	6.12	5.52	-	6.12	5.52	-	-	-	-	-	-	-
Critical Hdwy Stg 2	6.12	5.52	-	6.12	5.52	-	-	-	-	-	-	-
Follow-up Hdwy	3.518	4.018	3.318	3.518	4.018	3.318	2.218	-	-	2.218	-	-
Pot Cap-1 Maneuver	131	153	486	132	155	450	956	-	-	903	-	-
Stage 1	467	472	-	435	446	-	-	-	-	-	-	-
Stage 2	431	441	-	464	470	-	-	-	-	-	-	-
Platoon blocked, %												
Mov Cap-1 Maneuver	125	151	486	128	153	450	956	-	-	903	-	-
Mov Cap-2 Maneuver	125	151	-	128	153	-	-	-	-	-	-	-
Stage 1	465	468	-	433	444	-	-	-	-	-	-	-
Stage 2	414	439	-	450	466	-	-	-	-	-	-	-

Approach	EB	WB	NB	SB
HCM Control Delay, s	24.7	45.6	0.1	0.1
HCM LOS	C	E		

Minor Lane/Major Mvmt	NBL	NBT	NBR	EBLn1WBLn1	SBL	SBT	SBR
Capacity (veh/h)	956	-	-	205	154	903	-
HCM Lane V/C Ratio	0.004	-	-	0.11	0.44	0.007	-
HCM Control Delay (s)	8.8	-	-	24.7	45.6	9	-
HCM Lane LOS	A	-	-	C	E	A	-
HCM 95th %tile Q(veh)	0	-	-	0.4	2	0	-

Intersection

Int Delay, s/veh 1.6

Movement	EBL	EBT	EBR	WBL	WBT	WBR	NBL	NBT	NBR	SBL	SBT	SBR
Lane Configurations		↕			↕			↕			↕	
Traffic Vol, veh/h	6	16	0	1	65	0	3	2	0	2	2	3
Future Vol, veh/h	6	16	0	1	65	0	3	2	0	2	2	3
Conflicting Peds, #/hr	1	0	0	0	0	1	0	0	1	1	0	0
Sign Control	Free	Free	Free	Free	Free	Free	Stop	Stop	Stop	Stop	Stop	Stop
RT Channelized	-	-	None	-	-	None	-	-	None	-	-	None
Storage Length	-	-	-	-	-	-	-	-	-	-	-	-
Veh in Median Storage, #	-	0	-	-	0	-	-	0	-	-	0	-
Grade, %	-	0	-	-	0	-	-	0	-	-	0	-
Peak Hour Factor	74	74	74	74	74	74	74	74	74	74	74	74
Heavy Vehicles, %	0	0	0	0	0	0	33	0	0	0	0	0
Mvmt Flow	8	22	0	1	88	0	4	3	0	3	3	4

Major/Minor	Major1			Major2			Minor1			Minor2		
Conflicting Flow All	89	0	0	22	0	0	132	130	23	132	130	89
Stage 1	-	-	-	-	-	-	38	38	-	92	92	-
Stage 2	-	-	-	-	-	-	94	92	-	40	38	-
Critical Hdwy	4.1	-	-	4.1	-	-	7.43	6.5	6.2	7.1	6.5	6.2
Critical Hdwy Stg 1	-	-	-	-	-	-	6.43	5.5	-	6.1	5.5	-
Critical Hdwy Stg 2	-	-	-	-	-	-	6.43	5.5	-	6.1	5.5	-
Follow-up Hdwy	2.2	-	-	2.2	-	-	3.797	4	3.3	3.5	4	3.3
Pot Cap-1 Maneuver	1519	-	-	1607	-	-	773	764	1060	845	764	975
Stage 1	-	-	-	-	-	-	904	867	-	920	823	-
Stage 2	-	-	-	-	-	-	842	823	-	980	867	-
Platoon blocked, %	-	-	-	-	-	-	-	-	-	-	-	-
Mov Cap-1 Maneuver	1519	-	-	1605	-	-	764	759	1059	837	759	974
Mov Cap-2 Maneuver	-	-	-	-	-	-	764	759	-	837	759	-
Stage 1	-	-	-	-	-	-	899	863	-	915	821	-
Stage 2	-	-	-	-	-	-	835	821	-	971	863	-

Approach	EB	WB	NB	SB
HCM Control Delay, s	2	0.1	9.8	9.2
HCM LOS			A	A

Minor Lane/Major Mvmt	NBLn1	EBL	EBT	EBR	WBL	WBT	WBR	SBLn1
Capacity (veh/h)	762	1519	-	-	1605	-	-	864
HCM Lane V/C Ratio	0.009	0.005	-	-	0.001	-	-	0.011
HCM Control Delay (s)	9.8	7.4	0	-	7.2	0	-	9.2
HCM Lane LOS	A	A	A	-	A	A	-	A
HCM 95th %tile Q(veh)	0	0	-	-	0	-	-	0

Intersection												
Int Delay, s/veh	7.7											
Movement	EBL	EBT	EBR	WBL	WBT	WBR	NBL	NBT	NBR	SBL	SBT	SBR
Lane Configurations		↕			↕			↕			↕	
Traffic Vol, veh/h	0	14	0	1	65	9	2	17	0	1	4	0
Future Vol, veh/h	0	14	0	1	65	9	2	17	0	1	4	0
Conflicting Peds, #/hr	1	0	0	0	0	1	0	0	0	0	0	0
Sign Control	Stop	Stop	Stop	Stop	Stop	Stop	Free	Free	Free	Free	Free	Free
RT Channelized	-	-	None	-	-	None	-	-	None	-	-	None
Storage Length	-	-	-	-	-	-	-	-	-	-	-	-
Veh in Median Storage, #	-	0	-	-	0	-	-	0	-	-	0	-
Grade, %	-	0	-	-	0	-	-	0	-	-	0	-
Peak Hour Factor	83	83	83	83	83	83	83	83	83	83	83	83
Heavy Vehicles, %	0	0	0	0	0	0	0	6	0	0	0	0
Mvmt Flow	0	17	0	1	78	11	2	20	0	1	5	0
Major/Minor	Minor2			Minor1			Major1			Major2		
Conflicting Flow All	78	32	5	41	32	21	5	0	0	20	0	0
Stage 1	7	7	-	25	25	-	-	-	-	-	-	-
Stage 2	71	25	-	16	7	-	-	-	-	-	-	-
Critical Hdwy	7.1	6.5	6.2	7.1	6.5	6.2	4.1	-	-	4.1	-	-
Critical Hdwy Stg 1	6.1	5.5	-	6.1	5.5	-	-	-	-	-	-	-
Critical Hdwy Stg 2	6.1	5.5	-	6.1	5.5	-	-	-	-	-	-	-
Follow-up Hdwy	3.5	4	3.3	3.5	4	3.3	2.2	-	-	2.2	-	-
Pot Cap-1 Maneuver	916	865	1084	968	865	1062	1630	-	-	1609	-	-
Stage 1	1020	894	-	998	878	-	-	-	-	-	-	-
Stage 2	944	878	-	1009	894	-	-	-	-	-	-	-
Platoon blocked, %												
Mov Cap-1 Maneuver	842	863	1084	952	863	1061	1630	-	-	1607	-	-
Mov Cap-2 Maneuver	842	863	-	952	863	-	-	-	-	-	-	-
Stage 1	1019	893	-	997	877	-	-	-	-	-	-	-
Stage 2	849	877	-	989	893	-	-	-	-	-	-	-
Approach	EB			WB			NB			SB		
HCM Control Delay, s	9.3			9.5			0.8			1.4		
HCM LOS	A			A								
Minor Lane/Major Mvmt	NBL	NBT	NBR	EBLn1	WBLn1	SBL	SBT	SBR				
Capacity (veh/h)	1630	-	-	863	884	1607	-	-				
HCM Lane V/C Ratio	0.001	-	-	0.02	0.102	0.001	-	-				
HCM Control Delay (s)	7.2	0	-	9.3	9.5	7.2	0	-				
HCM Lane LOS	A	A	-	A	A	A	A	-				
HCM 95th %tile Q(veh)	0	-	-	0.1	0.3	0	-	-				

Intersection	
Intersection Delay, s/veh	7.2
Intersection LOS	A

Movement	EBU	EBL	EBT	EBR	WBU	WBL	WBT	WBR	NBU	NBL	NBT	NBR
Lane Configurations			↕				↕				↕	
Traffic Vol, veh/h	0	0	17	1	0	5	63	1	0	1	1	2
Future Vol, veh/h	0	0	17	1	0	5	63	1	0	1	1	2
Peak Hour Factor	0.92	0.90	0.90	0.90	0.92	0.90	0.90	0.90	0.92	0.90	0.90	0.90
Heavy Vehicles, %	2	0	6	0	2	0	0	0	2	0	0	0
Mvmt Flow	0	0	19	1	0	6	70	1	0	1	1	2
Number of Lanes	0	0	1	0	0	0	1	0	0	0	1	0

Approach	EB	WB	NB
Opposing Approach	WB	EB	SB
Opposing Lanes	1	1	1
Conflicting Approach Left	SB	NB	EB
Conflicting Lanes Left	1	1	1
Conflicting Approach Right	NB	SB	WB
Conflicting Lanes Right	1	1	1
HCM Control Delay	7.2	7.3	6.9
HCM LOS	A	A	A

Lane	NBLn1	EBLn1	WBLn1	SBLn1
Vol Left, %	25%	0%	7%	0%
Vol Thru, %	25%	94%	91%	0%
Vol Right, %	50%	6%	1%	100%
Sign Control	Stop	Stop	Stop	Stop
Traffic Vol by Lane	4	18	69	6
LT Vol	1	0	5	0
Through Vol	1	17	63	0
RT Vol	2	1	1	6
Lane Flow Rate	4	20	77	7
Geometry Grp	1	1	1	1
Degree of Util (X)	0.005	0.022	0.084	0.006
Departure Headway (Hd)	3.823	4.045	3.94	3.47
Convergence, Y/N	Yes	Yes	Yes	Yes
Cap	932	887	913	1026
Service Time	1.861	2.061	1.946	1.51
HCM Lane V/C Ratio	0.004	0.023	0.084	0.007
HCM Control Delay	6.9	7.2	7.3	6.5
HCM Lane LOS	A	A	A	A
HCM 95th-tile Q	0	0.1	0.3	0

Intersection

Intersection Delay, s/veh

Intersection LOS

Movement	SBU	SBL	SBT	SBR
Lane Configurations			↕	
Traffic Vol, veh/h	0	0	0	6
Future Vol, veh/h	0	0	0	6
Peak Hour Factor	0.92	0.90	0.90	0.90
Heavy Vehicles, %	2	0	0	0
Mvmt Flow	0	0	0	7
Number of Lanes	0	0	1	0

Approach SB

Opposing Approach	NB
Opposing Lanes	1
Conflicting Approach Left	WB
Conflicting Lanes Left	1
Conflicting Approach Right	EB
Conflicting Lanes Right	1
HCM Control Delay	6.5
HCM LOS	A

Intersection

Int Delay, s/veh 0.2

Movement	EBL	EBR	NBL	NBT	SBT	SBR
Lane Configurations	Y			Y	Y	
Traffic Vol, veh/h	3	6	7	642	581	0
Future Vol, veh/h	3	6	7	642	581	0
Conflicting Peds, #/hr	0	0	1	0	0	1
Sign Control	Stop	Stop	Free	Free	Free	Free
RT Channelized	-	None	-	None	-	None
Storage Length	0	-	-	-	-	-
Veh in Median Storage, #	0	-	-	0	0	-
Grade, %	0	-	-	0	0	-
Peak Hour Factor	93	93	93	93	93	93
Heavy Vehicles, %	2	2	2	2	2	2
Mvmt Flow	3	6	8	690	625	0

Major/Minor	Minor2	Major1	Major2
Conflicting Flow All	1331	626	0
Stage 1	626	-	-
Stage 2	705	-	-
Critical Hdwy	6.42	6.22	4.12
Critical Hdwy Stg 1	5.42	-	-
Critical Hdwy Stg 2	5.42	-	-
Follow-up Hdwy	3.518	3.318	2.218
Pot Cap-1 Maneuver	170	484	956
Stage 1	533	-	-
Stage 2	490	-	-
Platoon blocked, %			-
Mov Cap-1 Maneuver	167	484	956
Mov Cap-2 Maneuver	167	-	-
Stage 1	532	-	-
Stage 2	483	-	-

Approach	EB	NB	SB
HCM Control Delay, s	17.6	0.1	0
HCM LOS	C		

Minor Lane/Major Mvmt	NBL	NBT	EBLn1	SBT	SBR
Capacity (veh/h)	956	-	296	-	-
HCM Lane V/C Ratio	0.008	-	0.033	-	-
HCM Control Delay (s)	8.8	0	17.6	-	-
HCM Lane LOS	A	A	C	-	-
HCM 95th %tile Q(veh)	0	-	0.1	-	-

Intersection

Int Delay, s/veh 0.4

Movement	WBL	WBR	NBT	NBR	SBL	SBT
Lane Configurations	↘		↑	↗		↖
Traffic Vol, veh/h	11	5	678	18	5	878
Future Vol, veh/h	11	5	678	18	5	878
Conflicting Peds, #/hr	0	0	0	1	1	0
Sign Control	Stop	Stop	Free	Free	Free	Free
RT Channelized	-	None	-	None	-	None
Storage Length	0	-	-	125	-	-
Veh in Median Storage, #	0	-	0	-	-	0
Grade, %	0	-	0	-	-	0
Peak Hour Factor	95	95	95	95	95	95
Heavy Vehicles, %	0	0	2	0	0	2
Mvmt Flow	12	5	714	19	5	924

Major/Minor	Minor1		Major1		Major2	
Conflicting Flow All	1650	715	0	0	715	0
Stage 1	715	-	-	-	-	-
Stage 2	935	-	-	-	-	-
Critical Hdwy	6.4	6.2	-	-	4.1	-
Critical Hdwy Stg 1	5.4	-	-	-	-	-
Critical Hdwy Stg 2	5.4	-	-	-	-	-
Follow-up Hdwy	3.5	3.3	-	-	2.2	-
Pot Cap-1 Maneuver	110	434	-	-	895	-
Stage 1	488	-	-	-	-	-
Stage 2	385	-	-	-	-	-
Platoon blocked, %			-	-		
Mov Cap-1 Maneuver	109	434	-	-	895	-
Mov Cap-2 Maneuver	109	-	-	-	-	-
Stage 1	488	-	-	-	-	-
Stage 2	381	-	-	-	-	-

Approach	WB		NB		SB
HCM Control Delay, s	33.7		0		0.1
HCM LOS	D				

Minor Lane/Major Mvmt	NBT	NBRWBLn1	SBL	SBT
Capacity (veh/h)	-	- 142	895	-
HCM Lane V/C Ratio	-	- 0.119	0.006	-
HCM Control Delay (s)	-	- 33.7	9	0
HCM Lane LOS	-	- D	A	A
HCM 95th %tile Q(veh)	-	- 0.4	0	-

Intersection

Int Delay, s/veh 0.3

Movement	EBL	EBT	EBR	WBL	WBT	WBR	NBL	NBT	NBR	SBL	SBT	SBR
Lane Configurations		↔			↔		↑	↑		↑	↑	
Traffic Vol, veh/h	5	0	4	1	0	2	0	690	0	1	874	4
Future Vol, veh/h	5	0	4	1	0	2	0	690	0	1	874	4
Conflicting Peds, #/hr	5	0	0	0	0	5	0	0	4	4	0	0
Sign Control	Stop	Stop	Stop	Stop	Stop	Stop	Free	Free	Free	Free	Free	Free
RT Channelized	-	-	None	-	-	None	-	-	None	-	-	None
Storage Length	-	-	-	-	-	-	65	-	-	50	-	-
Veh in Median Storage, #	-	0	-	-	0	-	-	0	-	-	0	-
Grade, %	-	0	-	-	0	-	-	0	-	-	0	-
Peak Hour Factor	94	94	94	94	94	94	94	94	94	94	94	94
Heavy Vehicles, %	0	0	0	0	0	0	0	2	0	0	1	0
Mvmt Flow	5	0	4	1	0	2	0	734	0	1	930	4

Major/Minor	Minor2			Minor1			Major1			Major2		
Conflicting Flow All	1674	1672	932	1674	1674	743	934	0	0	738	0	0
Stage 1	934	934	-	738	738	-	-	-	-	-	-	-
Stage 2	740	738	-	936	936	-	-	-	-	-	-	-
Critical Hdwy	7.1	6.5	6.2	7.1	6.5	6.2	4.1	-	-	4.1	-	-
Critical Hdwy Stg 1	6.1	5.5	-	6.1	5.5	-	-	-	-	-	-	-
Critical Hdwy Stg 2	6.1	5.5	-	6.1	5.5	-	-	-	-	-	-	-
Follow-up Hdwy	3.5	4	3.3	3.5	4	3.3	2.2	-	-	2.2	-	-
Pot Cap-1 Maneuver	77	97	326	77	97	418	741	-	-	877	-	-
Stage 1	322	347	-	413	427	-	-	-	-	-	-	-
Stage 2	412	427	-	321	346	-	-	-	-	-	-	-
Platoon blocked, %												
Mov Cap-1 Maneuver	76	97	326	76	97	414	741	-	-	873	-	-
Mov Cap-2 Maneuver	76	97	-	76	97	-	-	-	-	-	-	-
Stage 1	322	347	-	411	425	-	-	-	-	-	-	-
Stage 2	408	425	-	316	346	-	-	-	-	-	-	-

Approach	EB	WB	NB	SB
HCM Control Delay, s	39.1	27	0	0
HCM LOS	E	D		

Minor Lane/Major Mvmt	NBL	NBT	NBR	EBLn1WBLn1	SBL	SBT	SBR
Capacity (veh/h)	741	-	-	115	167	873	-
HCM Lane V/C Ratio	-	-	-	0.083	0.019	0.001	-
HCM Control Delay (s)	0	-	-	39.1	27	9.1	-
HCM Lane LOS	A	-	-	E	D	A	-
HCM 95th %tile Q(veh)	0	-	-	0.3	0.1	0	-

Intersection

Int Delay, s/veh 0.6

Movement	WBL	WBR	NBT	NBR	SBL	SBT
Lane Configurations	↕		↔		↕	↕
Traffic Vol, veh/h	9	12	678	13	34	851
Future Vol, veh/h	9	12	678	13	34	851
Conflicting Peds, #/hr	0	0	0	2	2	0
Sign Control	Stop	Stop	Free	Free	Free	Free
RT Channelized	-	None	-	None	-	None
Storage Length	0	-	-	-	65	-
Veh in Median Storage, #	0	-	0	-	-	0
Grade, %	0	-	0	-	-	0
Peak Hour Factor	96	96	96	96	96	96
Heavy Vehicles, %	0	0	2	0	0	2
Mvmt Flow	9	13	706	14	35	886

Major/Minor	Minor1		Major1		Major2	
Conflicting Flow All	1672	715	0	0	722	0
Stage 1	715	-	-	-	-	-
Stage 2	957	-	-	-	-	-
Critical Hdwy	6.4	6.2	-	-	4.1	-
Critical Hdwy Stg 1	5.4	-	-	-	-	-
Critical Hdwy Stg 2	5.4	-	-	-	-	-
Follow-up Hdwy	3.5	3.3	-	-	2.2	-
Pot Cap-1 Maneuver	107	434	-	-	889	-
Stage 1	488	-	-	-	-	-
Stage 2	376	-	-	-	-	-
Platoon blocked, %			-	-		-
Mov Cap-1 Maneuver	103	433	-	-	889	-
Mov Cap-2 Maneuver	103	-	-	-	-	-
Stage 1	487	-	-	-	-	-
Stage 2	361	-	-	-	-	-

Approach	WB		NB		SB
HCM Control Delay, s	27.5		0		0.4
HCM LOS	D				

Minor Lane/Major Mvmt	NBT	NBRWBLn1	SBL	SBT
Capacity (veh/h)	-	-	182	889
HCM Lane V/C Ratio	-	-	0.12	0.04
HCM Control Delay (s)	-	-	27.5	9.2
HCM Lane LOS	-	-	D	A
HCM 95th %tile Q(veh)	-	-	0.4	0.1

Intersection						
Int Delay, s/veh	6.3					
Movement	WBL	WBR	NBT	NBR	SBL	SBT
Lane Configurations	Y		P			A
Traffic Vol, veh/h	4	6	1	6	19	0
Future Vol, veh/h	4	6	1	6	19	0
Conflicting Peds, #/hr	1	0	0	5	5	0
Sign Control	Stop	Stop	Free	Free	Free	Free
RT Channelized	-	None	-	None	-	None
Storage Length	0	-	-	-	-	-
Veh in Median Storage, #	0	-	0	-	-	0
Grade, %	0	-	0	-	-	0
Peak Hour Factor	75	75	75	75	75	75
Heavy Vehicles, %	0	17	0	0	0	0
Mvmt Flow	5	8	1	8	25	0
Major/Minor	Minor1		Major1		Major2	
Conflicting Flow All	62	10	0	0	14	0
Stage 1	10	-	-	-	-	-
Stage 2	52	-	-	-	-	-
Critical Hdwy	6.4	6.37	-	-	4.1	-
Critical Hdwy Stg 1	5.4	-	-	-	-	-
Critical Hdwy Stg 2	5.4	-	-	-	-	-
Follow-up Hdwy	3.5	3.453	-	-	2.2	-
Pot Cap-1 Maneuver	949	1029	-	-	1617	-
Stage 1	1018	-	-	-	-	-
Stage 2	976	-	-	-	-	-
Platoon blocked, %			-	-		
Mov Cap-1 Maneuver	929	1024	-	-	1617	-
Mov Cap-2 Maneuver	929	-	-	-	-	-
Stage 1	1013	-	-	-	-	-
Stage 2	960	-	-	-	-	-
Approach	WB		NB		SB	
HCM Control Delay, s	8.7		0		7.3	
HCM LOS	A					
Minor Lane/Major Mvmt	NBT	NBRWBLn1	SBL	SBT		
Capacity (veh/h)	-	- 984	1617	-		
HCM Lane V/C Ratio	-	- 0.014	0.016	-		
HCM Control Delay (s)	-	- 8.7	7.3	0		
HCM Lane LOS	-	- A	A	A		
HCM 95th %tile Q(veh)	-	- 0	0	-		

Intersection

Int Delay, s/veh 2

Movement	EBT	EBR	WBL	WBT	NBL	NBR
Lane Configurations	↔		↔		↔	
Traffic Vol, veh/h	8	16	1	4	7	0
Future Vol, veh/h	8	16	1	4	7	0
Conflicting Peds, #/hr	0	3	3	0	1	0
Sign Control	Free	Free	Free	Free	Stop	Stop
RT Channelized	-	None	-	None	-	None
Storage Length	-	-	-	-	0	-
Veh in Median Storage, #	0	-	-	0	0	-
Grade, %	0	-	-	0	0	-
Peak Hour Factor	69	69	69	69	69	69
Heavy Vehicles, %	0	0	0	0	29	0
Mvmt Flow	12	23	1	6	10	0

Major/Minor	Major1	Major2	Minor1
Conflicting Flow All	0	38	36
Stage 1	-	-	26
Stage 2	-	-	10
Critical Hdwy	-	4.1	6.69
Critical Hdwy Stg 1	-	-	5.69
Critical Hdwy Stg 2	-	-	5.69
Follow-up Hdwy	-	2.2	3.761
Pot Cap-1 Maneuver	-	1585	912
Stage 1	-	-	931
Stage 2	-	-	947
Platoon blocked, %	-	-	-
Mov Cap-1 Maneuver	-	1585	908
Mov Cap-2 Maneuver	-	-	908
Stage 1	-	-	928
Stage 2	-	-	945

Approach	EB	WB	NB
HCM Control Delay, s	0	1.5	9
HCM LOS			A

Minor Lane/Major Mvmt	NBLn1	EBT	EBR	WBL	WBT
Capacity (veh/h)	908	-	-	1585	-
HCM Lane V/C Ratio	0.011	-	-	0.001	-
HCM Control Delay (s)	9	-	-	7.3	0
HCM Lane LOS	A	-	-	A	A
HCM 95th %tile Q(veh)	0	-	-	0	-

Intersection

Int Delay, s/veh 1

Movement	EBL	EBT	EBR	WBL	WBT	WBR	NBL	NBT	NBR	SBL	SBT	SBR
Lane Configurations		↔			↔		↑	↑		↑	↑	
Traffic Vol, veh/h	7	0	7	7	0	17	10	668	7	28	821	5
Future Vol, veh/h	7	0	7	7	0	17	10	668	7	28	821	5
Conflicting Peds, #/hr	0	0	0	0	0	0	0	0	2	2	0	0
Sign Control	Stop	Stop	Stop	Stop	Stop	Stop	Free	Free	Free	Free	Free	Free
RT Channelized	-	-	None	-	-	None	-	-	None	-	-	None
Storage Length	-	-	-	-	-	-	125	-	-	125	-	-
Veh in Median Storage, #	-	0	-	-	0	-	-	0	-	-	0	-
Grade, %	-	0	-	-	0	-	-	0	-	-	0	-
Peak Hour Factor	96	96	96	96	96	96	96	96	96	96	96	96
Heavy Vehicles, %	0	0	0	0	0	0	0	2	14	7	2	0
Mvmt Flow	7	0	7	7	0	18	10	696	7	29	855	5

Major/Minor	Minor2			Minor1			Major1			Major2		
Conflicting Flow All	1645	1642	858	1642	1641	701	860	0	0	705	0	0
Stage 1	916	916	-	722	722	-	-	-	-	-	-	-
Stage 2	729	726	-	920	919	-	-	-	-	-	-	-
Critical Hdwy	7.1	6.5	6.2	7.1	6.5	6.2	4.1	-	-	4.17	-	-
Critical Hdwy Stg 1	6.1	5.5	-	6.1	5.5	-	-	-	-	-	-	-
Critical Hdwy Stg 2	6.1	5.5	-	6.1	5.5	-	-	-	-	-	-	-
Follow-up Hdwy	3.5	4	3.3	3.5	4	3.3	2.2	-	-	2.263	-	-
Pot Cap-1 Maneuver	80	101	359	81	101	442	790	-	-	870	-	-
Stage 1	329	354	-	421	434	-	-	-	-	-	-	-
Stage 2	417	433	-	327	353	-	-	-	-	-	-	-
Platoon blocked, %												
Mov Cap-1 Maneuver	74	96	359	76	96	441	790	-	-	870	-	-
Mov Cap-2 Maneuver	74	96	-	76	96	-	-	-	-	-	-	-
Stage 1	325	342	-	415	428	-	-	-	-	-	-	-
Stage 2	395	427	-	310	341	-	-	-	-	-	-	-

Approach	EB	WB	NB	SB
HCM Control Delay, s	38.2	27.6	0.1	0.3
HCM LOS	E	D		

Minor Lane/Major Mvmt	NBL	NBT	NBR	EBLn1	WBLn1	SBL	SBT	SBR
Capacity (veh/h)	790	-	-	123	184	870	-	-
HCM Lane V/C Ratio	0.013	-	-	0.119	0.136	0.034	-	-
HCM Control Delay (s)	9.6	-	-	38.2	27.6	9.3	-	-
HCM Lane LOS	A	-	-	E	D	A	-	-
HCM 95th %tile Q(veh)	0	-	-	0.4	0.5	0.1	-	-

Intersection

Int Delay, s/veh 2.6

Movement	EBL	EBT	EBR	WBL	WBT	WBR	NBL	NBT	NBR	SBL	SBT	SBR
Lane Configurations		↔			↔		↔	↔		↔	↔	
Traffic Vol, veh/h	3	0	3	32	0	13	5	673	42	17	815	10
Future Vol, veh/h	3	0	3	32	0	13	5	673	42	17	815	10
Conflicting Peds, #/hr	1	0	0	0	0	1	1	0	0	0	0	1
Sign Control	Stop	Stop	Stop	Stop	Stop	Stop	Free	Free	Free	Free	Free	Free
RT Channelized	-	-	None	-	-	None	-	-	None	-	-	None
Storage Length	-	-	-	-	-	-	80	-	-	125	-	-
Veh in Median Storage, #	-	0	-	-	0	-	-	0	-	-	0	-
Grade, %	-	0	-	-	0	-	-	0	-	-	0	-
Peak Hour Factor	91	91	91	91	91	91	91	91	91	91	91	91
Heavy Vehicles, %	2	2	2	2	2	2	2	2	2	2	2	2
Mvmt Flow	3	0	3	35	0	14	5	740	46	19	896	11

Major/Minor	Minor2			Minor1			Major1			Major2		
Conflicting Flow All	1721	1736	902	1714	1719	764	908	0	0	786	0	0
Stage 1	939	939	-	774	774	-	-	-	-	-	-	-
Stage 2	782	797	-	940	945	-	-	-	-	-	-	-
Critical Hdwy	7.12	6.52	6.22	7.12	6.52	6.22	4.12	-	-	4.12	-	-
Critical Hdwy Stg 1	6.12	5.52	-	6.12	5.52	-	-	-	-	-	-	-
Critical Hdwy Stg 2	6.12	5.52	-	6.12	5.52	-	-	-	-	-	-	-
Follow-up Hdwy	3.518	4.018	3.318	3.518	4.018	3.318	2.218	-	-	2.218	-	-
Pot Cap-1 Maneuver	70	87	336	71	90	404	750	-	-	833	-	-
Stage 1	317	343	-	391	408	-	-	-	-	-	-	-
Stage 2	387	399	-	316	340	-	-	-	-	-	-	-
Platoon blocked, %												
Mov Cap-1 Maneuver	66	84	336	69	87	404	750	-	-	832	-	-
Mov Cap-2 Maneuver	66	84	-	69	87	-	-	-	-	-	-	-
Stage 1	315	335	-	388	405	-	-	-	-	-	-	-
Stage 2	370	396	-	306	332	-	-	-	-	-	-	-

Approach	EB	WB	NB	SB
HCM Control Delay, s	39.8	84.1	0.1	0.2
HCM LOS	E	F		

Minor Lane/Major Mvmt	NBL	NBT	NBR	EBLn1	WBLn1	SBL	SBT	SBR
Capacity (veh/h)	750	-	-	110	91	832	-	-
HCM Lane V/C Ratio	0.007	-	-	0.06	0.543	0.022	-	-
HCM Control Delay (s)	9.8	-	-	39.8	84.1	9.4	-	-
HCM Lane LOS	A	-	-	E	F	A	-	-
HCM 95th %tile Q(veh)	0	-	-	0.2	2.4	0.1	-	-

Intersection												
Int Delay, s/veh	3.9											

Movement	EBL	EBT	EBR	WBL	WBT	WBR	NBL	NBT	NBR	SBL	SBT	SBR
Lane Configurations		↕			↕			↕			↕	
Traffic Vol, veh/h	13	35	2	0	34	4	9	7	6	3	8	12
Future Vol, veh/h	13	35	2	0	34	4	9	7	6	3	8	12
Conflicting Peds, #/hr	2	0	1	1	0	2	0	0	0	0	0	0
Sign Control	Free	Free	Free	Free	Free	Free	Stop	Stop	Stop	Stop	Stop	Stop
RT Channelized	-	-	None	-	-	None	-	-	None	-	-	None
Storage Length	-	-	-	-	-	-	-	-	-	-	-	-
Veh in Median Storage, #	-	0	-	-	0	-	-	0	-	-	0	-
Grade, %	-	0	-	-	0	-	-	0	-	-	0	-
Peak Hour Factor	79	79	79	79	79	79	79	79	79	79	79	79
Heavy Vehicles, %	0	3	0	0	0	0	0	0	0	33	0	0
Mvmt Flow	16	44	3	0	43	5	11	9	8	4	10	15

Major/Minor	Major1			Major2			Minor1			Minor2		
Conflicting Flow All	50	0	0	48	0	0	137	129	47	135	129	48
Stage 1	-	-	-	-	-	-	79	79	-	48	48	-
Stage 2	-	-	-	-	-	-	58	50	-	87	81	-
Critical Hdwy	4.1	-	-	4.1	-	-	7.1	6.5	6.2	7.43	6.5	6.2
Critical Hdwy Stg 1	-	-	-	-	-	-	6.1	5.5	-	6.43	5.5	-
Critical Hdwy Stg 2	-	-	-	-	-	-	6.1	5.5	-	6.43	5.5	-
Follow-up Hdwy	2.2	-	-	2.2	-	-	3.5	4	3.3	3.797	4	3.3
Pot Cap-1 Maneuver	1570	-	-	1572	-	-	838	765	1028	770	765	1027
Stage 1	-	-	-	-	-	-	935	833	-	892	859	-
Stage 2	-	-	-	-	-	-	959	857	-	849	832	-
Platoon blocked, %	-	-	-	-	-	-	-	-	-	-	-	-
Mov Cap-1 Maneuver	1570	-	-	1572	-	-	810	755	1027	750	755	1025
Mov Cap-2 Maneuver	-	-	-	-	-	-	810	755	-	750	755	-
Stage 1	-	-	-	-	-	-	925	824	-	881	857	-
Stage 2	-	-	-	-	-	-	934	855	-	825	823	-

Approach	EB	WB	NB	SB
HCM Control Delay, s	1.9	0	9.4	9.3
HCM LOS			A	A

Minor Lane/Major Mvmt	NBLn1	EBL	EBT	EBR	WBL	WBT	WBR	SBLn1
Capacity (veh/h)	839	1570	-	-	1572	-	-	874
HCM Lane V/C Ratio	0.033	0.01	-	-	-	-	-	0.033
HCM Control Delay (s)	9.4	7.3	0	-	0	-	-	9.3
HCM Lane LOS	A	A	A	-	A	-	-	A
HCM 95th %tile Q(veh)	0.1	0	-	-	0	-	-	0.1

Intersection

Int Delay, s/veh 7.5

Movement	EBL	EBT	EBR	WBL	WBT	WBR	NBL	NBT	NBR	SBL	SBT	SBR
Lane Configurations		↕			↕			↕			↕	
Traffic Vol, veh/h	0	39	3	9	33	2	4	6	5	15	12	2
Future Vol, veh/h	0	39	3	9	33	2	4	6	5	15	12	2
Conflicting Peds, #/hr	3	0	0	0	0	3	3	0	2	2	0	3
Sign Control	Stop	Stop	Stop	Stop	Stop	Stop	Free	Free	Free	Free	Free	Free
RT Channelized	-	-	None	-	-	None	-	-	None	-	-	None
Storage Length	-	-	-	-	-	-	-	-	-	-	-	-
Veh in Median Storage, #	-	0	-	-	0	-	-	0	-	-	0	-
Grade, %	-	0	-	-	0	-	-	0	-	-	0	-
Peak Hour Factor	86	86	86	86	86	86	86	86	86	86	86	86
Heavy Vehicles, %	0	5	0	22	0	0	0	0	0	0	8	0
Mvmt Flow	0	45	3	10	38	2	5	7	6	17	14	2

Major/Minor	Minor2			Minor1			Major1			Major2		
Conflicting Flow All	96	77	18	95	75	15	19	0	0	15	0	0
Stage 1	53	53	-	21	21	-	-	-	-	-	-	-
Stage 2	43	24	-	74	54	-	-	-	-	-	-	-
Critical Hdwy	7.1	6.55	6.2	7.32	6.5	6.2	4.1	-	-	4.1	-	-
Critical Hdwy Stg 1	6.1	5.55	-	6.32	5.5	-	-	-	-	-	-	-
Critical Hdwy Stg 2	6.1	5.55	-	6.32	5.5	-	-	-	-	-	-	-
Follow-up Hdwy	3.5	4.045	3.3	3.698	4	3.3	2.2	-	-	2.2	-	-
Pot Cap-1 Maneuver	891	808	1066	842	819	1070	1611	-	-	1616	-	-
Stage 1	965	845	-	948	882	-	-	-	-	-	-	-
Stage 2	976	869	-	888	854	-	-	-	-	-	-	-
Platoon blocked, %												
Mov Cap-1 Maneuver	843	793	1063	793	804	1065	1611	-	-	1611	-	-
Mov Cap-2 Maneuver	843	793	-	793	804	-	-	-	-	-	-	-
Stage 1	959	833	-	943	878	-	-	-	-	-	-	-
Stage 2	926	865	-	828	842	-	-	-	-	-	-	-

Approach	EB	WB	NB	SB
HCM Control Delay, s	9.7	9.7	1.9	3.8
HCM LOS	A	A		

Minor Lane/Major Mvmt	NBL	NBT	NBR	EBLn1	WBLn1	SBL	SBT	SBR
Capacity (veh/h)	1611	-	-	808	811	1611	-	-
HCM Lane V/C Ratio	0.003	-	-	0.06	0.063	0.011	-	-
HCM Control Delay (s)	7.2	0	-	9.7	9.7	7.3	0	-
HCM Lane LOS	A	A	-	A	A	A	A	-
HCM 95th %tile Q(veh)	0	-	-	0.2	0.2	0	-	-

Intersection	
Intersection Delay, s/veh	7.3
Intersection LOS	A

Movement	EBU	EBL	EBT	EBR	WBU	WBL	WBT	WBR	NBU	NBL	NBT	NBR
Lane Configurations			↕				↕				↕	
Traffic Vol, veh/h	0	2	53	6	0	1	32	0	0	5	2	3
Future Vol, veh/h	0	2	53	6	0	1	32	0	0	5	2	3
Peak Hour Factor	0.92	0.75	0.75	0.75	0.92	0.75	0.75	0.75	0.92	0.75	0.75	0.75
Heavy Vehicles, %	2	0	4	0	2	0	0	0	2	40	0	0
Mvmt Flow	0	3	71	8	0	1	43	0	0	7	3	4
Number of Lanes	0	0	1	0	0	0	1	0	0	0	1	0

Approach	EB	WB	NB
Opposing Approach	WB	EB	SB
Opposing Lanes	1	1	1
Conflicting Approach Left	SB	NB	EB
Conflicting Lanes Left	1	1	1
Conflicting Approach Right	NB	SB	WB
Conflicting Lanes Right	1	1	1
HCM Control Delay	7.3	7.2	7.9
HCM LOS	A	A	A

Lane	NBLn1	EBLn1	WBLn1	SBLn1
Vol Left, %	50%	3%	3%	0%
Vol Thru, %	20%	87%	97%	0%
Vol Right, %	30%	10%	0%	100%
Sign Control	Stop	Stop	Stop	Stop
Traffic Vol by Lane	10	61	33	4
LT Vol	5	2	1	0
Through Vol	2	53	32	0
RT Vol	3	6	0	4
Lane Flow Rate	13	81	44	5
Geometry Grp	1	1	1	1
Degree of Util (X)	0.017	0.088	0.049	0.005
Departure Headway (Hd)	4.721	3.914	4	3.525
Convergence, Y/N	Yes	Yes	Yes	Yes
Cap	755	917	895	1006
Service Time	2.771	1.932	2.023	1.579
HCM Lane V/C Ratio	0.017	0.088	0.049	0.005
HCM Control Delay	7.9	7.3	7.2	6.6
HCM Lane LOS	A	A	A	A
HCM 95th-tile Q	0.1	0.3	0.2	0

Intersection

Intersection Delay, s/veh

Intersection LOS

Movement	SBU	SBL	SBT	SBR
Lane Configurations			↕	
Traffic Vol, veh/h	0	0	0	4
Future Vol, veh/h	0	0	0	4
Peak Hour Factor	0.92	0.75	0.75	0.75
Heavy Vehicles, %	2	0	0	0
Mvmt Flow	0	0	0	5
Number of Lanes	0	0	1	0

Approach SB

Opposing Approach	NB
Opposing Lanes	1
Conflicting Approach Left	WB
Conflicting Lanes Left	1
Conflicting Approach Right	EB
Conflicting Lanes Right	1
HCM Control Delay	6.6
HCM LOS	A

Intersection

Int Delay, s/veh 0.1

Movement	EBL	EBR	NBL	NBT	SBT	SBR
Lane Configurations	Y			Y	Y	
Traffic Vol, veh/h	1	2	8	704	844	1
Future Vol, veh/h	1	2	8	704	844	1
Conflicting Peds, #/hr	0	0	0	0	0	0
Sign Control	Stop	Stop	Free	Free	Free	Free
RT Channelized	-	None	-	None	-	None
Storage Length	0	-	-	-	-	-
Veh in Median Storage, #	0	-	-	0	0	-
Grade, %	0	-	-	0	0	-
Peak Hour Factor	91	91	91	91	91	92
Heavy Vehicles, %	2	2	2	2	2	2
Mvmt Flow	1	2	9	774	927	1

Major/Minor	Minor2		Major1		Major2	
Conflicting Flow All	1719	928	929	0	-	0
Stage 1	928	-	-	-	-	-
Stage 2	791	-	-	-	-	-
Critical Hdwy	6.42	6.22	4.12	-	-	-
Critical Hdwy Stg 1	5.42	-	-	-	-	-
Critical Hdwy Stg 2	5.42	-	-	-	-	-
Follow-up Hdwy	3.518	3.318	2.218	-	-	-
Pot Cap-1 Maneuver	99	325	736	-	-	-
Stage 1	385	-	-	-	-	-
Stage 2	447	-	-	-	-	-
Platoon blocked, %				-	-	-
Mov Cap-1 Maneuver	97	325	736	-	-	-
Mov Cap-2 Maneuver	97	-	-	-	-	-
Stage 1	385	-	-	-	-	-
Stage 2	438	-	-	-	-	-

Approach	EB	NB	SB
HCM Control Delay, s	25.1	0.1	0
HCM LOS	D		

Minor Lane/Major Mvmt	NBL	NBT	EBLn1	SBT	SBR
Capacity (veh/h)	736	-	182	-	-
HCM Lane V/C Ratio	0.012	-	0.018	-	-
HCM Control Delay (s)	9.9	0	25.1	-	-
HCM Lane LOS	A	A	D	-	-
HCM 95th %tile Q(veh)	0	-	0.1	-	-

Intersection

Int Delay, s/veh 0.2

Movement	WBL	WBR	NBT	NBR	SBL	SBT
Lane Configurations	↘↗		↑	↗		↖
Traffic Vol, veh/h	7	3	749	9	4	968
Future Vol, veh/h	7	3	749	9	4	968
Conflicting Peds, #/hr	0	0	0	1	1	0
Sign Control	Stop	Stop	Free	Free	Free	Free
RT Channelized	-	None	-	None	-	None
Storage Length	0	-	-	125	-	-
Veh in Median Storage, #	0	-	0	-	-	0
Grade, %	0	-	0	-	-	0
Peak Hour Factor	96	96	96	96	96	96
Heavy Vehicles, %	0	0	2	0	0	1
Mvmt Flow	7	3	780	9	4	1008

Major/Minor	Minor1		Major1		Major2	
Conflicting Flow All	1798	781	0	0	781	0
Stage 1	781	-	-	-	-	-
Stage 2	1017	-	-	-	-	-
Critical Hdwy	6.4	6.2	-	-	4.1	-
Critical Hdwy Stg 1	5.4	-	-	-	-	-
Critical Hdwy Stg 2	5.4	-	-	-	-	-
Follow-up Hdwy	3.5	3.3	-	-	2.2	-
Pot Cap-1 Maneuver	89	398	-	-	845	-
Stage 1	455	-	-	-	-	-
Stage 2	352	-	-	-	-	-
Platoon blocked, %			-	-		
Mov Cap-1 Maneuver	88	398	-	-	845	-
Mov Cap-2 Maneuver	88	-	-	-	-	-
Stage 1	455	-	-	-	-	-
Stage 2	348	-	-	-	-	-

Approach	WB		NB		SB
HCM Control Delay, s	39.4		0		0
HCM LOS	E				

Minor Lane/Major Mvmt	NBT	NBRWBLn1	SBL	SBT
Capacity (veh/h)	-	- 115	845	-
HCM Lane V/C Ratio	-	- 0.091	0.005	-
HCM Control Delay (s)	-	- 39.4	9.3	0
HCM Lane LOS	-	- E	A	A
HCM 95th %tile Q(veh)	-	- 0.3	0	-

Intersection												
Int Delay, s/veh	0											
Movement	EBL	EBT	EBR	WBL	WBT	WBR	NBL	NBT	NBR	SBL	SBT	SBR
Lane Configurations		↕			↕		↕	↕		↕	↕	
Traffic Vol, veh/h	0	0	0	1	0	1	2	748	0	1	977	4
Future Vol, veh/h	0	0	0	1	0	1	2	748	0	1	977	4
Conflicting Peds, #/hr	0	0	1	1	0	0	0	0	3	3	0	0
Sign Control	Stop	Stop	Stop	Stop	Stop	Stop	Free	Free	Free	Free	Free	Free
RT Channelized	-	-	None	-	-	None	-	-	None	-	-	None
Storage Length	-	-	-	-	-	-	65	-	-	50	-	-
Veh in Median Storage, #	-	0	-	-	0	-	-	0	-	-	0	-
Grade, %	-	0	-	-	0	-	-	0	-	-	0	-
Peak Hour Factor	96	96	96	96	96	96	96	96	96	96	96	96
Heavy Vehicles, %	0	0	0	0	0	0	0	3	0	0	2	0
Mvmt Flow	0	0	0	1	0	1	2	779	0	1	1018	4
Major/Minor	Minor2			Minor1			Major1			Major2		
Conflicting Flow All	1806	1808	1021	1809	1810	782	1022	0	0	782	0	0
Stage 1	1022	1022	-	786	786	-	-	-	-	-	-	-
Stage 2	784	786	-	1023	1024	-	-	-	-	-	-	-
Critical Hdwy	7.1	6.5	6.2	7.1	6.5	6.2	4.1	-	-	4.1	-	-
Critical Hdwy Stg 1	6.1	5.5	-	6.1	5.5	-	-	-	-	-	-	-
Critical Hdwy Stg 2	6.1	5.5	-	6.1	5.5	-	-	-	-	-	-	-
Follow-up Hdwy	3.5	4	3.3	3.5	4	3.3	2.2	-	-	2.2	-	-
Pot Cap-1 Maneuver	62	80	289	62	80	397	687	-	-	845	-	-
Stage 1	287	316	-	388	406	-	-	-	-	-	-	-
Stage 2	389	406	-	287	315	-	-	-	-	-	-	-
Platoon blocked, %												
Mov Cap-1 Maneuver	62	79	289	62	79	396	686	-	-	845	-	-
Mov Cap-2 Maneuver	62	79	-	62	79	-	-	-	-	-	-	-
Stage 1	286	316	-	386	404	-	-	-	-	-	-	-
Stage 2	387	404	-	286	315	-	-	-	-	-	-	-
Approach	EB			WB			NB			SB		
HCM Control Delay, s	0			39.3			0			0		
HCM LOS	A			E								
Minor Lane/Major Mvmt	NBL	NBT	NBR	EBLn1	WBLn1	SBL	SBT	SBR				
Capacity (veh/h)	686	-	-	-	107	845	-	-				
HCM Lane V/C Ratio	0.003	-	-	-	0.019	0.001	-	-				
HCM Control Delay (s)	10.3	-	-	0	39.3	9.3	-	-				
HCM Lane LOS	B	-	-	A	E	A	-	-				
HCM 95th %tile Q(veh)	0	-	-	-	0.1	0	-	-				

Intersection

Int Delay, s/veh 0.6

Movement	WBL	WBR	NBT	NBR	SBL	SBT
Lane Configurations	↕		↔		↕	↕
Traffic Vol, veh/h	10	19	734	8	19	958
Future Vol, veh/h	10	19	734	8	19	958
Conflicting Peds, #/hr	0	0	0	1	1	0
Sign Control	Stop	Stop	Free	Free	Free	Free
RT Channelized	-	None	-	None	-	None
Storage Length	0	-	-	-	65	-
Veh in Median Storage, #	0	-	0	-	-	0
Grade, %	0	-	0	-	-	0
Peak Hour Factor	93	93	93	93	93	93
Heavy Vehicles, %	0	9	2	0	0	1
Mvmt Flow	11	20	789	9	20	1030

Major/Minor	Minor1		Major1		Major2	
Conflicting Flow All	1866	795	0	0	799	0
Stage 1	795	-	-	-	-	-
Stage 2	1071	-	-	-	-	-
Critical Hdwy	6.4	6.29	-	-	4.1	-
Critical Hdwy Stg 1	5.4	-	-	-	-	-
Critical Hdwy Stg 2	5.4	-	-	-	-	-
Follow-up Hdwy	3.5	3.381	-	-	2.2	-
Pot Cap-1 Maneuver	81	377	-	-	833	-
Stage 1	448	-	-	-	-	-
Stage 2	332	-	-	-	-	-
Platoon blocked, %			-	-		-
Mov Cap-1 Maneuver	79	377	-	-	833	-
Mov Cap-2 Maneuver	79	-	-	-	-	-
Stage 1	448	-	-	-	-	-
Stage 2	324	-	-	-	-	-

Approach	WB		NB		SB
HCM Control Delay, s	32		0		0.2
HCM LOS	D				

Minor Lane/Major Mvmt	NBT	NBRWBLn1	SBL	SBT
Capacity (veh/h)	-	- 164	833	-
HCM Lane V/C Ratio	-	- 0.19	0.025	-
HCM Control Delay (s)	-	- 32	9.4	-
HCM Lane LOS	-	- D	A	-
HCM 95th %tile Q(veh)	-	- 0.7	0.1	-

Intersection

Int Delay, s/veh 6.7

Movement	WBL	WBR	NBT	NBR	SBL	SBT
Lane Configurations	Y		P			A
Traffic Vol, veh/h	3	13	1	2	6	2
Future Vol, veh/h	3	13	1	2	6	2
Conflicting Peds, #/hr	2	0	0	0	0	0
Sign Control	Stop	Stop	Free	Free	Free	Free
RT Channelized	-	None	-	None	-	None
Storage Length	0	-	-	-	-	-
Veh in Median Storage, #	0	-	0	-	-	0
Grade, %	0	-	0	-	-	0
Peak Hour Factor	75	75	75	75	75	75
Heavy Vehicles, %	33	8	0	0	0	0
Mvmt Flow	4	17	1	3	8	3

Major/Minor	Minor1		Major1		Major2	
Conflicting Flow All	24	3	0	0	4	0
Stage 1	3	-	-	-	-	-
Stage 2	21	-	-	-	-	-
Critical Hdwy	6.73	6.28	-	-	4.1	-
Critical Hdwy Stg 1	5.73	-	-	-	-	-
Critical Hdwy Stg 2	5.73	-	-	-	-	-
Follow-up Hdwy	3.797	3.372	-	-	2.2	-
Pot Cap-1 Maneuver	918	1064	-	-	1631	-
Stage 1	945	-	-	-	-	-
Stage 2	927	-	-	-	-	-
Platoon blocked, %			-	-		-
Mov Cap-1 Maneuver	912	1064	-	-	1631	-
Mov Cap-2 Maneuver	912	-	-	-	-	-
Stage 1	945	-	-	-	-	-
Stage 2	921	-	-	-	-	-

Approach	WB		NB		SB
HCM Control Delay, s	8.6		0		5.4
HCM LOS	A				

Minor Lane/Major Mvmt	NBT	NBRWBLn1	SBL	SBT
Capacity (veh/h)	-	- 1032	1631	-
HCM Lane V/C Ratio	-	- 0.021	0.005	-
HCM Control Delay (s)	-	- 8.6	7.2	0
HCM Lane LOS	-	- A	A	A
HCM 95th %tile Q(veh)	-	- 0.1	0	-

Intersection

Int Delay, s/veh 5.9

Movement	EBT	EBR	WBL	WBT	NBL	NBR
Lane Configurations	↔		↔		↔	
Traffic Vol, veh/h	2	5	1	0	13	1
Future Vol, veh/h	2	5	1	0	13	1
Conflicting Peds, #/hr	0	1	1	0	0	0
Sign Control	Free	Free	Free	Free	Stop	Stop
RT Channelized	-	None	-	None	-	None
Storage Length	-	-	-	-	0	-
Veh in Median Storage, #	0	-	-	0	0	-
Grade, %	0	-	-	0	0	-
Peak Hour Factor	79	79	79	79	79	79
Heavy Vehicles, %	0	0	100	0	15	0
Mvmt Flow	3	6	1	0	16	1

Major/Minor	Major1	Major2	Minor1
Conflicting Flow All	0	10	10
Stage 1	-	-	7
Stage 2	-	-	3
Critical Hdwy	-	5.1	6.55
Critical Hdwy Stg 1	-	-	5.55
Critical Hdwy Stg 2	-	-	5.55
Follow-up Hdwy	-	3.1	3.635
Pot Cap-1 Maneuver	-	1150	977
Stage 1	-	-	983
Stage 2	-	-	987
Platoon blocked, %	-	-	-
Mov Cap-1 Maneuver	-	1150	975
Mov Cap-2 Maneuver	-	-	975
Stage 1	-	-	982
Stage 2	-	-	986

Approach	EB	WB	NB
HCM Control Delay, s	0	8.1	8.7
HCM LOS			A

Minor Lane/Major Mvmt	NBLn1	EBT	EBR	WBL	WBT
Capacity (veh/h)	982	-	-	1150	-
HCM Lane V/C Ratio	0.018	-	-	0.001	-
HCM Control Delay (s)	8.7	-	-	8.1	0
HCM Lane LOS	A	-	-	A	A
HCM 95th %tile Q(veh)	0.1	-	-	0	-

Intersection

Int Delay, s/veh 0.8

Movement	EBL	EBT	EBR	WBL	WBT	WBR	NBL	NBT	NBR	SBL	SBT	SBR
Lane Configurations		↕			↕		↕	↕		↕	↕	
Traffic Vol, veh/h	0	0	6	6	1	25	9	721	2	22	938	5
Future Vol, veh/h	0	0	6	6	1	25	9	721	2	22	938	5
Conflicting Peds, #/hr	0	0	0	0	0	0	0	0	1	1	0	0
Sign Control	Stop	Stop	Stop	Stop	Stop	Stop	Free	Free	Free	Free	Free	Free
RT Channelized	-	-	None	-	-	None	-	-	None	-	-	None
Storage Length	-	-	-	-	-	-	125	-	-	125	-	-
Veh in Median Storage, #	-	0	-	-	0	-	-	0	-	-	0	-
Grade, %	-	0	-	-	0	-	-	0	-	-	0	-
Peak Hour Factor	95	95	95	95	95	95	95	95	95	95	95	95
Heavy Vehicles, %	0	0	0	17	0	4	0	3	0	5	1	0
Mvmt Flow	0	0	6	6	1	26	9	759	2	23	987	5

Major/Minor	Minor2			Minor1			Major1			Major2		
Conflicting Flow All	1829	1817	990	1819	1819	761	993	0	0	762	0	0
Stage 1	1036	1036	-	780	780	-	-	-	-	-	-	-
Stage 2	793	781	-	1039	1039	-	-	-	-	-	-	-
Critical Hdwy	7.1	6.5	6.2	7.27	6.5	6.24	4.1	-	-	4.15	-	-
Critical Hdwy Stg 1	6.1	5.5	-	6.27	5.5	-	-	-	-	-	-	-
Critical Hdwy Stg 2	6.1	5.5	-	6.27	5.5	-	-	-	-	-	-	-
Follow-up Hdwy	3.5	4	3.3	3.653	4	3.336	2.2	-	-	2.245	-	-
Pot Cap-1 Maneuver	60	79	302	55	79	402	704	-	-	837	-	-
Stage 1	282	311	-	367	409	-	-	-	-	-	-	-
Stage 2	385	408	-	261	310	-	-	-	-	-	-	-
Platoon blocked, %												
Mov Cap-1 Maneuver	54	76	302	52	76	402	704	-	-	837	-	-
Mov Cap-2 Maneuver	54	76	-	52	76	-	-	-	-	-	-	-
Stage 1	278	302	-	362	403	-	-	-	-	-	-	-
Stage 2	354	402	-	249	301	-	-	-	-	-	-	-

Approach	EB	WB	NB	SB
HCM Control Delay, s	17.2	31.7	0.1	0.2
HCM LOS	C	D		

Minor Lane/Major Mvmt	NBL	NBT	NBR	EBLn1	WBLn1	SBL	SBT	SBR
Capacity (veh/h)	704	-	-	302	168	837	-	-
HCM Lane V/C Ratio	0.013	-	-	0.021	0.201	0.028	-	-
HCM Control Delay (s)	10.2	-	-	17.2	31.7	9.4	-	-
HCM Lane LOS	B	-	-	C	D	A	-	-
HCM 95th %tile Q(veh)	0	-	-	0.1	0.7	0.1	-	-

Intersection

Int Delay, s/veh 3.4

Movement	EBL	EBT	EBR	WBL	WBT	WBR	NBL	NBT	NBR	SBL	SBT	SBR
Lane Configurations		↔			↔		↔	↔		↔	↔	
Traffic Vol, veh/h	6	3	21	23	3	23	28	705	36	7	938	7
Future Vol, veh/h	6	3	21	23	3	23	28	705	36	7	938	7
Conflicting Peds, #/hr	1	0	0	0	0	1	0	0	0	0	0	0
Sign Control	Stop	Stop	Stop	Stop	Stop	Stop	Free	Free	Free	Free	Free	Free
RT Channelized	-	-	None	-	-	None	-	-	None	-	-	None
Storage Length	-	-	-	-	-	-	80	-	-	125	-	-
Veh in Median Storage, #	-	0	-	-	0	-	-	0	-	-	0	-
Grade, %	-	0	-	-	0	-	-	0	-	-	0	-
Peak Hour Factor	95	95	95	95	95	95	95	95	95	95	95	95
Heavy Vehicles, %	2	2	2	2	2	2	2	2	2	2	2	2
Mvmt Flow	6	3	22	24	3	24	29	742	38	7	987	7

Major/Minor	Minor2			Minor1			Major1			Major2		
Conflicting Flow All	1841	1845	991	1838	1829	762	995	0	0	780	0	0
Stage 1	1006	1006	-	820	820	-	-	-	-	-	-	-
Stage 2	835	839	-	1018	1009	-	-	-	-	-	-	-
Critical Hdwy	7.12	6.52	6.22	7.12	6.52	6.22	4.12	-	-	4.12	-	-
Critical Hdwy Stg 1	6.12	5.52	-	6.12	5.52	-	-	-	-	-	-	-
Critical Hdwy Stg 2	6.12	5.52	-	6.12	5.52	-	-	-	-	-	-	-
Follow-up Hdwy	3.518	4.018	3.318	3.518	4.018	3.318	2.218	-	-	2.218	-	-
Pot Cap-1 Maneuver	58	75	299	58	77	405	695	-	-	837	-	-
Stage 1	291	319	-	369	389	-	-	-	-	-	-	-
Stage 2	362	381	-	286	318	-	-	-	-	-	-	-
Platoon blocked, %												
Mov Cap-1 Maneuver	51	71	299	50	73	405	695	-	-	836	-	-
Mov Cap-2 Maneuver	51	71	-	50	73	-	-	-	-	-	-	-
Stage 1	279	316	-	354	373	-	-	-	-	-	-	-
Stage 2	323	365	-	260	315	-	-	-	-	-	-	-

Approach	EB	WB	NB	SB
HCM Control Delay, s	41.4	92.3	0.4	0.1
HCM LOS	E	F		

Minor Lane/Major Mvmt	NBL	NBT	NBR	EBLn1	WBLn1	SBL	SBT	SBR
Capacity (veh/h)	695	-	-	130	88	836	-	-
HCM Lane V/C Ratio	0.042	-	-	0.243	0.586	0.009	-	-
HCM Control Delay (s)	10.4	-	-	41.4	92.3	9.3	-	-
HCM Lane LOS	B	-	-	E	F	A	-	-
HCM 95th %tile Q(veh)	0.1	-	-	0.9	2.7	0	-	-

Intersection

Int Delay, s/veh 4.5

Movement	EBL	EBT	EBR	WBL	WBT	WBR	NBL	NBT	NBR	SBL	SBT	SBR
Lane Configurations		↕			↕			↕			↕	
Traffic Vol, veh/h	25	33	2	5	31	17	10	9	3	6	17	8
Future Vol, veh/h	25	33	2	5	31	17	10	9	3	6	17	8
Conflicting Peds, #/hr	1	0	0	0	0	1	0	0	2	2	0	0
Sign Control	Free	Free	Free	Free	Free	Free	Stop	Stop	Stop	Stop	Stop	Stop
RT Channelized	-	-	None	-	-	None	-	-	None	-	-	None
Storage Length	-	-	-	-	-	-	-	-	-	-	-	-
Veh in Median Storage, #	-	0	-	-	0	-	-	0	-	-	0	-
Grade, %	-	0	-	-	0	-	-	0	-	-	0	-
Peak Hour Factor	83	83	83	83	83	83	83	83	83	83	83	83
Heavy Vehicles, %	0	0	0	0	0	0	0	0	0	0	0	0
Mvmt Flow	30	40	2	6	37	20	12	11	4	7	20	10

Major/Minor	Major1			Major2			Minor1			Minor2		
Conflicting Flow All	59	0	0	42	0	0	176	172	43	171	163	49
Stage 1	-	-	-	-	-	-	101	101	-	61	61	-
Stage 2	-	-	-	-	-	-	75	71	-	110	102	-
Critical Hdwy	4.1	-	-	4.1	-	-	7.1	6.5	6.2	7.1	6.5	6.2
Critical Hdwy Stg 1	-	-	-	-	-	-	6.1	5.5	-	6.1	5.5	-
Critical Hdwy Stg 2	-	-	-	-	-	-	6.1	5.5	-	6.1	5.5	-
Follow-up Hdwy	2.2	-	-	2.2	-	-	3.5	4	3.3	3.5	4	3.3
Pot Cap-1 Maneuver	1558	-	-	1580	-	-	791	725	1033	797	733	1025
Stage 1	-	-	-	-	-	-	910	815	-	955	848	-
Stage 2	-	-	-	-	-	-	939	840	-	900	815	-
Platoon blocked, %	-	-	-	-	-	-	-	-	-	-	-	-
Mov Cap-1 Maneuver	1558	-	-	1577	-	-	752	707	1031	768	715	1024
Mov Cap-2 Maneuver	-	-	-	-	-	-	752	707	-	768	715	-
Stage 1	-	-	-	-	-	-	892	799	-	935	844	-
Stage 2	-	-	-	-	-	-	904	836	-	865	799	-

Approach	EB	WB	NB	SB
HCM Control Delay, s	3.1	0.7	9.9	9.8
HCM LOS			A	A

Minor Lane/Major Mvmt	NBLn1	EBL	EBT	EBR	WBL	WBT	WBR	SBLn1
Capacity (veh/h)	760	1558	-	-	1577	-	-	787
HCM Lane V/C Ratio	0.035	0.019	-	-	0.004	-	-	0.047
HCM Control Delay (s)	9.9	7.4	0	-	7.3	0	-	9.8
HCM Lane LOS	A	A	A	-	A	A	-	A
HCM 95th %tile Q(veh)	0.1	0.1	-	-	0	-	-	0.1

Intersection												
Int Delay, s/veh	6.9											
Movement	EBL	EBT	EBR	WBL	WBT	WBR	NBL	NBT	NBR	SBL	SBT	SBR
Lane Configurations		↕			↕			↕			↕	
Traffic Vol, veh/h	2	37	3	10	37	2	7	13	7	8	16	3
Future Vol, veh/h	2	37	3	10	37	2	7	13	7	8	16	3
Conflicting Peds, #/hr	4	0	0	0	0	4	1	0	1	1	0	1
Sign Control	Stop	Stop	Stop	Stop	Stop	Stop	Free	Free	Free	Free	Free	Free
RT Channelized	-	-	None	-	-	None	-	-	None	-	-	None
Storage Length	-	-	-	-	-	-	-	-	-	-	-	-
Veh in Median Storage, #	-	0	-	-	0	-	-	0	-	-	0	-
Grade, %	-	0	-	-	0	-	-	0	-	-	0	-
Peak Hour Factor	84	84	84	84	84	84	84	84	84	84	84	84
Heavy Vehicles, %	0	0	0	0	0	0	0	8	14	0	6	0
Mvmt Flow	2	44	4	12	44	2	8	15	8	10	19	4
Major/Minor	Minor2			Minor1			Major1			Major2		
Conflicting Flow All	105	82	22	101	80	25	24	0	0	25	0	0
Stage 1	41	41	-	37	37	-	-	-	-	-	-	-
Stage 2	64	41	-	64	43	-	-	-	-	-	-	-
Critical Hdwy	7.1	6.5	6.2	7.1	6.5	6.2	4.1	-	-	4.1	-	-
Critical Hdwy Stg 1	6.1	5.5	-	6.1	5.5	-	-	-	-	-	-	-
Critical Hdwy Stg 2	6.1	5.5	-	6.1	5.5	-	-	-	-	-	-	-
Follow-up Hdwy	3.5	4	3.3	3.5	4	3.3	2.2	-	-	2.2	-	-
Pot Cap-1 Maneuver	880	812	1061	885	814	1057	1604	-	-	1603	-	-
Stage 1	979	865	-	984	868	-	-	-	-	-	-	-
Stage 2	952	865	-	952	863	-	-	-	-	-	-	-
Platoon blocked, %												
Mov Cap-1 Maneuver	830	802	1060	837	804	1052	1604	-	-	1597	-	-
Mov Cap-2 Maneuver	830	802	-	837	804	-	-	-	-	-	-	-
Stage 1	973	859	-	978	863	-	-	-	-	-	-	-
Stage 2	893	860	-	895	857	-	-	-	-	-	-	-
Approach	EB			WB			NB			SB		
HCM Control Delay, s	9.7			9.7			1.9			2.2		
HCM LOS	A			A								
Minor Lane/Major Mvmt	NBL	NBT	NBR	EBLn1	WBLn1	SBL	SBT	SBR				
Capacity (veh/h)	1604	-	-	818	818	1597	-	-				
HCM Lane V/C Ratio	0.005	-	-	0.061	0.071	0.006	-	-				
HCM Control Delay (s)	7.3	0	-	9.7	9.7	7.3	0	-				
HCM Lane LOS	A	A	-	A	A	A	A	-				
HCM 95th %tile Q(veh)	0	-	-	0.2	0.2	0	-	-				

Intersection	
Intersection Delay, s/veh	7.2
Intersection LOS	A

Movement	EBU	EBL	EBT	EBR	WBU	WBL	WBT	WBR	NBU	NBL	NBT	NBR
Lane Configurations			↕				↕				↕	
Traffic Vol, veh/h	0	4	45	3	0	2	40	0	0	4	1	4
Future Vol, veh/h	0	4	45	3	0	2	40	0	0	4	1	4
Peak Hour Factor	0.92	0.83	0.83	0.83	0.92	0.83	0.83	0.83	0.92	0.83	0.83	0.83
Heavy Vehicles, %	2	0	2	0	2	0	0	0	2	0	0	0
Mvmt Flow	0	5	54	4	0	2	48	0	0	5	1	5
Number of Lanes	0	0	1	0	0	0	1	0	0	0	1	0

Approach	EB	WB	NB
Opposing Approach	WB	EB	SB
Opposing Lanes	1	1	1
Conflicting Approach Left	SB	NB	EB
Conflicting Lanes Left	1	1	1
Conflicting Approach Right	NB	SB	WB
Conflicting Lanes Right	1	1	1
HCM Control Delay	7.3	7.2	7
HCM LOS	A	A	A

Lane	NBLn1	EBLn1	WBLn1	SBLn1
Vol Left, %	44%	8%	5%	0%
Vol Thru, %	11%	87%	95%	14%
Vol Right, %	44%	6%	0%	86%
Sign Control	Stop	Stop	Stop	Stop
Traffic Vol by Lane	9	52	42	7
LT Vol	4	4	2	0
Through Vol	1	45	40	1
RT Vol	4	3	0	6
Lane Flow Rate	11	63	51	8
Geometry Grp	1	1	1	1
Degree of Util (X)	0.012	0.069	0.056	0.008
Departure Headway (Hd)	3.924	3.952	3.99	3.59
Convergence, Y/N	Yes	Yes	Yes	Yes
Cap	907	908	899	990
Service Time	1.971	1.967	2.007	1.638
HCM Lane V/C Ratio	0.012	0.069	0.057	0.008
HCM Control Delay	7	7.3	7.2	6.7
HCM Lane LOS	A	A	A	A
HCM 95th-tile Q	0	0.2	0.2	0

Intersection

Intersection Delay, s/veh

Intersection LOS

Movement	SBU	SBL	SBT	SBR
Lane Configurations			↕	
Traffic Vol, veh/h	0	0	1	6
Future Vol, veh/h	0	0	1	6
Peak Hour Factor	0.92	0.83	0.83	0.83
Heavy Vehicles, %	2	0	0	0
Mvmt Flow	0	0	1	7
Number of Lanes	0	0	1	0

Approach SB

Opposing Approach	NB
Opposing Lanes	1
Conflicting Approach Left	WB
Conflicting Lanes Left	1
Conflicting Approach Right	EB
Conflicting Lanes Right	1
HCM Control Delay	6.7
HCM LOS	A

Intersection

Int Delay, s/veh 0.2

Movement	EBL	EBR	NBL	NBT	SBT	SBR
Lane Configurations	↘			↗	↗	
Traffic Vol, veh/h	3	8	4	732	945	5
Future Vol, veh/h	3	8	4	732	945	5
Conflicting Peds, #/hr	0	0	1	0	0	1
Sign Control	Stop	Stop	Free	Free	Free	Free
RT Channelized	-	None	-	None	-	None
Storage Length	0	-	-	-	-	-
Veh in Median Storage, #	0	-	-	0	0	-
Grade, %	0	-	-	0	0	-
Peak Hour Factor	95	95	95	95	95	95
Heavy Vehicles, %	2	2	2	2	2	2
Mvmt Flow	3	8	4	771	995	5

Major/Minor	Minor2		Major1		Major2	
Conflicting Flow All	1777	998	1001	0	-	0
Stage 1	998	-	-	-	-	-
Stage 2	779	-	-	-	-	-
Critical Hdwy	6.42	6.22	4.12	-	-	-
Critical Hdwy Stg 1	5.42	-	-	-	-	-
Critical Hdwy Stg 2	5.42	-	-	-	-	-
Follow-up Hdwy	3.518	3.318	2.218	-	-	-
Pot Cap-1 Maneuver	91	296	692	-	-	-
Stage 1	357	-	-	-	-	-
Stage 2	452	-	-	-	-	-
Platoon blocked, %				-	-	-
Mov Cap-1 Maneuver	90	296	692	-	-	-
Mov Cap-2 Maneuver	90	-	-	-	-	-
Stage 1	357	-	-	-	-	-
Stage 2	447	-	-	-	-	-

Approach	EB	NB	SB
HCM Control Delay, s	26.1	0.1	0
HCM LOS	D		

Minor Lane/Major Mvmt	NBL	NBT	EBLn1	SBT	SBR
Capacity (veh/h)	692	-	182	-	-
HCM Lane V/C Ratio	0.006	-	0.064	-	-
HCM Control Delay (s)	10.2	0	26.1	-	-
HCM Lane LOS	B	A	D	-	-
HCM 95th %tile Q(veh)	0	-	0.2	-	-

APPENDIX 5. FUTURE OPERATIONS RESULTS

Intersection

Int Delay, s/veh 0.4

Movement	WBL	WBR	NBT	NBR	SBL	SBT
Lane Configurations	↘		↑	↗		↖
Traffic Vol, veh/h	14	7	696	15	1	584
Future Vol, veh/h	14	7	696	15	1	584
Conflicting Peds, #/hr	0	0	0	0	0	0
Sign Control	Stop	Stop	Free	Free	Free	Free
RT Channelized	-	None	-	None	-	None
Storage Length	0	-	-	125	-	-
Veh in Median Storage, #	0	-	0	-	-	0
Grade, %	0	-	0	-	-	0
Peak Hour Factor	92	92	92	92	92	92
Heavy Vehicles, %	0	0	6	0	0	4
Mvmt Flow	15	8	757	16	1	635

Major/Minor	Minor1		Major1		Major2	
Conflicting Flow All	1394	757	0	0	757	0
Stage 1	757	-	-	-	-	-
Stage 2	637	-	-	-	-	-
Critical Hdwy	6.4	6.2	-	-	4.1	-
Critical Hdwy Stg 1	5.4	-	-	-	-	-
Critical Hdwy Stg 2	5.4	-	-	-	-	-
Follow-up Hdwy	3.5	3.3	-	-	2.2	-
Pot Cap-1 Maneuver	158	411	-	-	863	-
Stage 1	467	-	-	-	-	-
Stage 2	531	-	-	-	-	-
Platoon blocked, %			-	-		
Mov Cap-1 Maneuver	158	411	-	-	863	-
Mov Cap-2 Maneuver	158	-	-	-	-	-
Stage 1	467	-	-	-	-	-
Stage 2	530	-	-	-	-	-

Approach	WB		NB		SB
HCM Control Delay, s	25.4		0		0
HCM LOS	D				

Minor Lane/Major Mvmt	NBT	NBRWBLn1	SBL	SBT
Capacity (veh/h)	-	- 199	863	-
HCM Lane V/C Ratio	-	- 0.115	0.001	-
HCM Control Delay (s)	-	- 25.4	9.2	0
HCM Lane LOS	-	- D	A	A
HCM 95th %tile Q(veh)	-	- 0.4	0	-

Intersection

Int Delay, s/veh 0.1

Movement	EBL	EBT	EBR	WBL	WBT	WBR	NBL	NBT	NBR	SBL	SBT	SBR
Lane Configurations		↔			↔		↑	↑		↑	↑	
Traffic Vol, veh/h	4	0	1	0	0	0	0	701	0	0	610	4
Future Vol, veh/h	4	0	1	0	0	0	0	701	0	0	610	4
Conflicting Peds, #/hr	1	0	0	0	0	1	1	0	1	1	0	1
Sign Control	Stop	Stop	Stop	Stop	Stop	Stop	Free	Free	Free	Free	Free	Free
RT Channelized	-	-	None	-	-	None	-	-	None	-	-	None
Storage Length	-	-	-	-	-	-	65	-	-	50	-	-
Veh in Median Storage, #	-	0	-	-	0	-	-	0	-	-	0	-
Grade, %	-	0	-	-	0	-	-	0	-	-	0	-
Peak Hour Factor	93	93	93	93	93	93	93	93	93	93	93	93
Heavy Vehicles, %	0	0	0	0	0	0	0	6	0	0	4	0
Mvmt Flow	4	0	1	0	0	0	0	754	0	0	656	4

Major/Minor	Minor2			Minor1			Major1			Major2		
Conflicting Flow All	1414	1414	659	1414	1416	756	661	0	0	755	0	0
Stage 1	659	659	-	755	755	-	-	-	-	-	-	-
Stage 2	755	755	-	659	661	-	-	-	-	-	-	-
Critical Hdwy	7.1	6.5	6.2	7.1	6.5	6.2	4.1	-	-	4.1	-	-
Critical Hdwy Stg 1	6.1	5.5	-	6.1	5.5	-	-	-	-	-	-	-
Critical Hdwy Stg 2	6.1	5.5	-	6.1	5.5	-	-	-	-	-	-	-
Follow-up Hdwy	3.5	4	3.3	3.5	4	3.3	2.2	-	-	2.2	-	-
Pot Cap-1 Maneuver	116	139	467	116	139	411	937	-	-	865	-	-
Stage 1	456	464	-	404	420	-	-	-	-	-	-	-
Stage 2	404	420	-	456	463	-	-	-	-	-	-	-
Platoon blocked, %												
Mov Cap-1 Maneuver	116	139	467	116	139	410	937	-	-	864	-	-
Mov Cap-2 Maneuver	116	139	-	116	139	-	-	-	-	-	-	-
Stage 1	456	464	-	404	420	-	-	-	-	-	-	-
Stage 2	404	420	-	455	463	-	-	-	-	-	-	-

Approach	EB	WB	NB	SB
HCM Control Delay, s	32.3	0	0	0
HCM LOS	D	A		

Minor Lane/Major Mvmt	NBL	NBT	NBR	EBLn1WBLn1	SBL	SBT	SBR
Capacity (veh/h)	937	-	-	137	-	864	-
HCM Lane V/C Ratio	-	-	-	0.039	-	-	-
HCM Control Delay (s)	0	-	-	32.3	0	0	-
HCM Lane LOS	A	-	-	D	A	A	-
HCM 95th %tile Q(veh)	0	-	-	0.1	-	0	-

Intersection

Int Delay, s/veh 0.3

Movement	WBL	WBR	NBT	NBR	SBL	SBT
Lane Configurations	Y		P		T	T
Traffic Vol, veh/h	0	23	675	0	5	599
Future Vol, veh/h	0	23	675	0	5	599
Conflicting Peds, #/hr	0	0	0	0	0	0
Sign Control	Stop	Stop	Free	Free	Free	Free
RT Channelized	-	None	-	None	-	None
Storage Length	0	-	-	-	65	-
Veh in Median Storage, #	0	-	0	-	-	0
Grade, %	0	-	0	-	-	0
Peak Hour Factor	92	92	92	92	92	92
Heavy Vehicles, %	0	0	6	0	0	4
Mvmt Flow	0	25	734	0	5	651

Major/Minor	Minor1		Major1		Major2	
Conflicting Flow All	1396	734	0	0	734	0
Stage 1	734	-	-	-	-	-
Stage 2	662	-	-	-	-	-
Critical Hdwy	6.4	6.2	-	-	4.1	-
Critical Hdwy Stg 1	5.4	-	-	-	-	-
Critical Hdwy Stg 2	5.4	-	-	-	-	-
Follow-up Hdwy	3.5	3.3	-	-	2.2	-
Pot Cap-1 Maneuver	157	423	-	-	880	-
Stage 1	478	-	-	-	-	-
Stage 2	517	-	-	-	-	-
Platoon blocked, %			-	-		
Mov Cap-1 Maneuver	156	423	-	-	880	-
Mov Cap-2 Maneuver	156	-	-	-	-	-
Stage 1	478	-	-	-	-	-
Stage 2	514	-	-	-	-	-

Approach	WB		NB		SB
HCM Control Delay, s	14		0		0.1
HCM LOS	B				

Minor Lane/Major Mvmt	NBT	NBRWBLn1	SBL	SBT
Capacity (veh/h)	-	-	423	880
HCM Lane V/C Ratio	-	-	0.059	0.006
HCM Control Delay (s)	-	-	14	9.1
HCM Lane LOS	-	-	B	A
HCM 95th %tile Q(veh)	-	-	0.2	0

Intersection

Int Delay, s/veh 7.6

Movement	WBL	WBR	NBT	NBR	SBL	SBT
Lane Configurations	Y		P			A
Traffic Vol, veh/h	1	22	1	0	5	1
Future Vol, veh/h	1	22	1	0	5	1
Conflicting Peds, #/hr	0	0	0	0	0	0
Sign Control	Stop	Stop	Free	Free	Free	Free
RT Channelized	-	None	-	None	-	None
Storage Length	0	-	-	-	-	-
Veh in Median Storage, #	0	-	0	-	-	0
Grade, %	0	-	0	-	-	0
Peak Hour Factor	75	75	75	75	75	75
Heavy Vehicles, %	0	0	0	0	0	0
Mvmt Flow	1	29	1	0	7	1

Major/Minor	Minor1	Major1	Major2
Conflicting Flow All	16	1	0
Stage 1	1	-	-
Stage 2	15	-	-
Critical Hdwy	6.4	6.2	4.1
Critical Hdwy Stg 1	5.4	-	-
Critical Hdwy Stg 2	5.4	-	-
Follow-up Hdwy	3.5	3.3	2.2
Pot Cap-1 Maneuver	1008	1090	1635
Stage 1	1028	-	-
Stage 2	1013	-	-
Platoon blocked, %			
Mov Cap-1 Maneuver	1004	1090	1635
Mov Cap-2 Maneuver	1004	-	-
Stage 1	1028	-	-
Stage 2	1009	-	-

Approach	WB	NB	SB
HCM Control Delay, s	8.4	0	6
HCM LOS	A		

Minor Lane/Major Mvmt	NBT	NBRWBLn1	SBL	SBT
Capacity (veh/h)	-	- 1086	1635	-
HCM Lane V/C Ratio	-	- 0.028	0.004	-
HCM Control Delay (s)	-	- 8.4	7.2	0
HCM Lane LOS	-	- A	A	A
HCM 95th %tile Q(veh)	-	- 0.1	0	-

Intersection

Int Delay, s/veh 5.7

Movement	EBT	EBR	WBL	WBT	NBL	NBR
Lane Configurations	↔			↔	↔	
Traffic Vol, veh/h	2	3	0	4	18	0
Future Vol, veh/h	2	3	0	4	18	0
Conflicting Peds, #/hr	0	0	0	0	0	1
Sign Control	Free	Free	Free	Free	Stop	Stop
RT Channelized	-	None	-	None	-	None
Storage Length	-	-	-	-	0	-
Veh in Median Storage, #	0	-	-	0	0	-
Grade, %	0	-	-	0	0	-
Peak Hour Factor	70	70	70	70	70	70
Heavy Vehicles, %	0	0	0	0	0	0
Mvmt Flow	3	4	0	6	26	0

Major/Minor	Major1	Major2	Minor1
Conflicting Flow All	0	0	11
Stage 1	-	-	5
Stage 2	-	-	6
Critical Hdwy	-	4.1	6.4
Critical Hdwy Stg 1	-	-	5.4
Critical Hdwy Stg 2	-	-	5.4
Follow-up Hdwy	-	2.2	3.5
Pot Cap-1 Maneuver	-	1627	1014
Stage 1	-	-	1023
Stage 2	-	-	1022
Platoon blocked, %	-	-	-
Mov Cap-1 Maneuver	-	1625	1014
Mov Cap-2 Maneuver	-	-	1014
Stage 1	-	-	1023
Stage 2	-	-	1022

Approach	EB	WB	NB
HCM Control Delay, s	0	0	8.6
HCM LOS			A

Minor Lane/Major Mvmt	NBLn1	EBT	EBR	WBL	WBT
Capacity (veh/h)	1014	-	-	1625	-
HCM Lane V/C Ratio	0.025	-	-	-	-
HCM Control Delay (s)	8.6	-	-	0	-
HCM Lane LOS	A	-	-	A	-
HCM 95th %tile Q(veh)	0.1	-	-	0	-

Intersection												
Int Delay, s/veh	0.6											
Movement	EBL	EBT	EBR	WBL	WBT	WBR	NBL	NBT	NBR	SBL	SBT	SBR
Lane Configurations		↕			↕		↕	↕		↕	↕	
Traffic Vol, veh/h	3	0	5	2	0	26	4	648	4	10	582	0
Future Vol, veh/h	3	0	5	2	0	26	4	648	4	10	582	0
Conflicting Peds, #/hr	0	0	0	0	0	0	1	0	0	0	0	1
Sign Control	Stop	Stop	Stop	Stop	Stop	Stop	Free	Free	Free	Free	Free	Free
RT Channelized	-	-	None	-	-	None	-	-	None	-	-	None
Storage Length	-	-	-	-	-	-	125	-	-	125	-	-
Veh in Median Storage, #	-	0	-	-	0	-	-	0	-	-	0	-
Grade, %	-	0	-	-	0	-	-	0	-	-	0	-
Peak Hour Factor	90	90	90	90	90	90	90	90	90	90	90	90
Heavy Vehicles, %	0	0	0	0	0	4	0	6	0	0	4	0
Mvmt Flow	3	0	6	2	0	29	4	720	4	11	647	0

Major/Minor	Minor2			Minor1			Major1			Major2		
Conflicting Flow All	1416	1403	648	1403	1401	722	648	0	0	724	0	0
Stage 1	670	670	-	731	731	-	-	-	-	-	-	-
Stage 2	746	733	-	672	670	-	-	-	-	-	-	-
Critical Hdwy	7.1	6.5	6.2	7.1	6.5	6.24	4.1	-	-	4.1	-	-
Critical Hdwy Stg 1	6.1	5.5	-	6.1	5.5	-	-	-	-	-	-	-
Critical Hdwy Stg 2	6.1	5.5	-	6.1	5.5	-	-	-	-	-	-	-
Follow-up Hdwy	3.5	4	3.3	3.5	4	3.336	2.2	-	-	2.2	-	-
Pot Cap-1 Maneuver	116	141	474	118	141	423	947	-	-	888	-	-
Stage 1	450	459	-	416	430	-	-	-	-	-	-	-
Stage 2	409	429	-	449	459	-	-	-	-	-	-	-
Platoon blocked, %												
Mov Cap-1 Maneuver	107	139	474	115	139	423	947	-	-	888	-	-
Mov Cap-2 Maneuver	107	139	-	115	139	-	-	-	-	-	-	-
Stage 1	448	453	-	414	428	-	-	-	-	-	-	-
Stage 2	379	427	-	438	453	-	-	-	-	-	-	-

Approach	EB	WB	NB	SB
HCM Control Delay, s	23.2	16.1	0.1	0.2
HCM LOS	C	C		

Minor Lane/Major Mvmt	NBL	NBT	NBR	EBLn1WBLn1	SBL	SBT	SBR
Capacity (veh/h)	947	-	-	207	355	888	-
HCM Lane V/C Ratio	0.005	-	-	0.043	0.088	0.013	-
HCM Control Delay (s)	8.8	-	-	23.2	16.1	9.1	-
HCM Lane LOS	A	-	-	C	C	A	-
HCM 95th %tile Q(veh)	0	-	-	0.1	0.3	0	-

Intersection

Int Delay, s/veh 2.7

Movement	EBL	EBT	EBR	WBL	WBT	WBR	NBL	NBT	NBR	SBL	SBT	SBR
Lane Configurations		↔			↔		↔	↔		↔	↔	
Traffic Vol, veh/h	10	0	11	48	0	15	4	636	21	6	578	6
Future Vol, veh/h	10	0	11	48	0	15	4	636	21	6	578	6
Conflicting Peds, #/hr	0	0	0	0	0	0	1	0	0	0	0	1
Sign Control	Stop	Stop	Stop	Stop	Stop	Stop	Free	Free	Free	Free	Free	Free
RT Channelized	-	-	None	-	-	None	-	-	None	-	-	None
Storage Length	-	-	-	-	-	-	80	-	-	125	-	-
Veh in Median Storage, #	-	0	-	-	0	-	-	0	-	-	0	-
Grade, %	-	0	-	-	0	-	-	0	-	-	0	-
Peak Hour Factor	93	93	93	93	93	93	93	93	93	93	93	93
Heavy Vehicles, %	2	2	2	2	2	2	2	2	2	2	2	2
Mvmt Flow	11	0	12	52	0	16	4	684	23	6	622	6

Major/Minor	Minor2			Minor1			Major1			Major2		
Conflicting Flow All	1351	1354	626	1348	1346	695	629	0	0	706	0	0
Stage 1	639	639	-	704	704	-	-	-	-	-	-	-
Stage 2	712	715	-	644	642	-	-	-	-	-	-	-
Critical Hdwy	7.12	6.52	6.22	7.12	6.52	6.22	4.12	-	-	4.12	-	-
Critical Hdwy Stg 1	6.12	5.52	-	6.12	5.52	-	-	-	-	-	-	-
Critical Hdwy Stg 2	6.12	5.52	-	6.12	5.52	-	-	-	-	-	-	-
Follow-up Hdwy	3.518	4.018	3.318	3.518	4.018	3.318	2.218	-	-	2.218	-	-
Pot Cap-1 Maneuver	127	150	484	128	151	442	953	-	-	892	-	-
Stage 1	464	470	-	428	440	-	-	-	-	-	-	-
Stage 2	423	434	-	461	469	-	-	-	-	-	-	-
Platoon blocked, %												
Mov Cap-1 Maneuver	121	148	484	124	149	442	953	-	-	892	-	-
Mov Cap-2 Maneuver	121	148	-	124	149	-	-	-	-	-	-	-
Stage 1	462	466	-	426	438	-	-	-	-	-	-	-
Stage 2	406	432	-	447	465	-	-	-	-	-	-	-

Approach	EB	WB	NB	SB
HCM Control Delay, s	25.4	47.4	0.1	0.1
HCM LOS	D	E		

Minor Lane/Major Mvmt	NBL	NBT	NBR	EBLn1	WBLn1	SBL	SBT	SBR
Capacity (veh/h)	953	-	-	199	150	892	-	-
HCM Lane V/C Ratio	0.005	-	-	0.113	0.452	0.007	-	-
HCM Control Delay (s)	8.8	-	-	25.4	47.4	9.1	-	-
HCM Lane LOS	A	-	-	D	E	A	-	-
HCM 95th %tile Q(veh)	0	-	-	0.4	2.1	0	-	-

Intersection

Int Delay, s/veh 1.6

Movement	EBL	EBT	EBR	WBL	WBT	WBR	NBL	NBT	NBR	SBL	SBT	SBR
Lane Configurations		↕			↕			↕			↕	
Traffic Vol, veh/h	6	16	0	1	65	0	3	2	0	2	2	3
Future Vol, veh/h	6	16	0	1	65	0	3	2	0	2	2	3
Conflicting Peds, #/hr	1	0	0	0	0	1	0	0	1	1	0	0
Sign Control	Free	Free	Free	Free	Free	Free	Stop	Stop	Stop	Stop	Stop	Stop
RT Channelized	-	-	None	-	-	None	-	-	None	-	-	None
Storage Length	-	-	-	-	-	-	-	-	-	-	-	-
Veh in Median Storage, #	-	0	-	-	0	-	-	0	-	-	0	-
Grade, %	-	0	-	-	0	-	-	0	-	-	0	-
Peak Hour Factor	74	74	74	74	74	74	74	74	74	74	74	74
Heavy Vehicles, %	0	0	0	0	0	0	33	0	0	0	0	0
Mvmt Flow	8	22	0	1	88	0	4	3	0	3	3	4

Major/Minor	Major1			Major2			Minor1			Minor2		
Conflicting Flow All	89	0	0	22	0	0	132	130	23	132	130	89
Stage 1	-	-	-	-	-	-	38	38	-	92	92	-
Stage 2	-	-	-	-	-	-	94	92	-	40	38	-
Critical Hdwy	4.1	-	-	4.1	-	-	7.43	6.5	6.2	7.1	6.5	6.2
Critical Hdwy Stg 1	-	-	-	-	-	-	6.43	5.5	-	6.1	5.5	-
Critical Hdwy Stg 2	-	-	-	-	-	-	6.43	5.5	-	6.1	5.5	-
Follow-up Hdwy	2.2	-	-	2.2	-	-	3.797	4	3.3	3.5	4	3.3
Pot Cap-1 Maneuver	1519	-	-	1607	-	-	773	764	1060	845	764	975
Stage 1	-	-	-	-	-	-	904	867	-	920	823	-
Stage 2	-	-	-	-	-	-	842	823	-	980	867	-
Platoon blocked, %	-	-	-	-	-	-	-	-	-	-	-	-
Mov Cap-1 Maneuver	1519	-	-	1605	-	-	764	759	1059	837	759	974
Mov Cap-2 Maneuver	-	-	-	-	-	-	764	759	-	837	759	-
Stage 1	-	-	-	-	-	-	899	863	-	915	821	-
Stage 2	-	-	-	-	-	-	835	821	-	971	863	-

Approach	EB	WB	NB	SB
HCM Control Delay, s	2	0.1	9.8	9.2
HCM LOS			A	A

Minor Lane/Major Mvmt	NBLn1	EBL	EBT	EBR	WBL	WBT	WBR	SBLn1
Capacity (veh/h)	762	1519	-	-	1605	-	-	864
HCM Lane V/C Ratio	0.009	0.005	-	-	0.001	-	-	0.011
HCM Control Delay (s)	9.8	7.4	0	-	7.2	0	-	9.2
HCM Lane LOS	A	A	A	-	A	A	-	A
HCM 95th %tile Q(veh)	0	0	-	-	0	-	-	0

Intersection

Int Delay, s/veh 7.7

Movement	EBL	EBT	EBR	WBL	WBT	WBR	NBL	NBT	NBR	SBL	SBT	SBR
Lane Configurations		↕			↕			↕			↕	
Traffic Vol, veh/h	0	14	0	1	65	9	2	17	0	1	4	0
Future Vol, veh/h	0	14	0	1	65	9	2	17	0	1	4	0
Conflicting Peds, #/hr	1	0	0	0	0	1	0	0	0	0	0	0
Sign Control	Stop	Stop	Stop	Stop	Stop	Stop	Free	Free	Free	Free	Free	Free
RT Channelized	-	-	None	-	-	None	-	-	None	-	-	None
Storage Length	-	-	-	-	-	-	-	-	-	-	-	-
Veh in Median Storage, #	-	0	-	-	0	-	-	0	-	-	0	-
Grade, %	-	0	-	-	0	-	-	0	-	-	0	-
Peak Hour Factor	83	83	83	83	83	83	83	83	83	83	83	83
Heavy Vehicles, %	0	0	0	0	0	0	0	6	0	0	0	0
Mvmt Flow	0	17	0	1	78	11	2	20	0	1	5	0

Major/Minor	Minor2			Minor1			Major1			Major2		
Conflicting Flow All	78	32	5	41	32	21	5	0	0	20	0	0
Stage 1	7	7	-	25	25	-	-	-	-	-	-	-
Stage 2	71	25	-	16	7	-	-	-	-	-	-	-
Critical Hdwy	7.1	6.5	6.2	7.1	6.5	6.2	4.1	-	-	4.1	-	-
Critical Hdwy Stg 1	6.1	5.5	-	6.1	5.5	-	-	-	-	-	-	-
Critical Hdwy Stg 2	6.1	5.5	-	6.1	5.5	-	-	-	-	-	-	-
Follow-up Hdwy	3.5	4	3.3	3.5	4	3.3	2.2	-	-	2.2	-	-
Pot Cap-1 Maneuver	916	865	1084	968	865	1062	1630	-	-	1609	-	-
Stage 1	1020	894	-	998	878	-	-	-	-	-	-	-
Stage 2	944	878	-	1009	894	-	-	-	-	-	-	-
Platoon blocked, %												
Mov Cap-1 Maneuver	842	863	1084	952	863	1061	1630	-	-	1607	-	-
Mov Cap-2 Maneuver	842	863	-	952	863	-	-	-	-	-	-	-
Stage 1	1019	893	-	997	877	-	-	-	-	-	-	-
Stage 2	849	877	-	989	893	-	-	-	-	-	-	-

Approach	EB	WB	NB	SB
HCM Control Delay, s	9.3	9.5	0.8	1.4
HCM LOS	A	A		

Minor Lane/Major Mvmt	NBL	NBT	NBR	EBLn1WBLn1	SBL	SBT	SBR
Capacity (veh/h)	1630	-	-	863 884	1607	-	-
HCM Lane V/C Ratio	0.001	-	-	0.02 0.102	0.001	-	-
HCM Control Delay (s)	7.2	0	-	9.3 9.5	7.2	0	-
HCM Lane LOS	A	A	-	A A	A	A	-
HCM 95th %tile Q(veh)	0	-	-	0.1 0.3	0	-	-

Intersection	
Intersection Delay, s/veh	7.2
Intersection LOS	A

Movement	EBU	EBL	EBT	EBR	WBU	WBL	WBT	WBR	NBU	NBL	NBT	NBR
Lane Configurations			↕				↕				↕	
Traffic Vol, veh/h	0	0	17	1	0	5	63	1	0	1	1	2
Future Vol, veh/h	0	0	17	1	0	5	63	1	0	1	1	2
Peak Hour Factor	0.92	0.90	0.90	0.90	0.92	0.90	0.90	0.90	0.92	0.90	0.90	0.90
Heavy Vehicles, %	2	0	6	0	2	0	0	0	2	0	0	0
Mvmt Flow	0	0	19	1	0	6	70	1	0	1	1	2
Number of Lanes	0	0	1	0	0	0	1	0	0	0	1	0

Approach	EB	WB	NB
Opposing Approach	WB	EB	SB
Opposing Lanes	1	1	1
Conflicting Approach Left	SB	NB	EB
Conflicting Lanes Left	1	1	1
Conflicting Approach Right	NB	SB	WB
Conflicting Lanes Right	1	1	1
HCM Control Delay	7.2	7.3	6.9
HCM LOS	A	A	A

Lane	NBLn1	EBLn1	WBLn1	SBLn1
Vol Left, %	25%	0%	7%	0%
Vol Thru, %	25%	94%	91%	0%
Vol Right, %	50%	6%	1%	100%
Sign Control	Stop	Stop	Stop	Stop
Traffic Vol by Lane	4	18	69	6
LT Vol	1	0	5	0
Through Vol	1	17	63	0
RT Vol	2	1	1	6
Lane Flow Rate	4	20	77	7
Geometry Grp	1	1	1	1
Degree of Util (X)	0.005	0.022	0.084	0.006
Departure Headway (Hd)	3.823	4.045	3.94	3.47
Convergence, Y/N	Yes	Yes	Yes	Yes
Cap	932	887	913	1026
Service Time	1.861	2.061	1.946	1.51
HCM Lane V/C Ratio	0.004	0.023	0.084	0.007
HCM Control Delay	6.9	7.2	7.3	6.5
HCM Lane LOS	A	A	A	A
HCM 95th-tile Q	0	0.1	0.3	0

Intersection

Intersection Delay, s/veh

Intersection LOS

Movement	SBU	SBL	SBT	SBR
Lane Configurations			↕	
Traffic Vol, veh/h	0	0	0	6
Future Vol, veh/h	0	0	0	6
Peak Hour Factor	0.92	0.90	0.90	0.90
Heavy Vehicles, %	2	0	0	0
Mvmt Flow	0	0	0	7
Number of Lanes	0	0	1	0

Approach SB

Opposing Approach	NB
Opposing Lanes	1
Conflicting Approach Left	WB
Conflicting Lanes Left	1
Conflicting Approach Right	EB
Conflicting Lanes Right	1
HCM Control Delay	6.5
HCM LOS	A

Intersection

Int Delay, s/veh 0.2

Movement	EBL	EBR	NBL	NBT	SBT	SBR
Lane Configurations	Y			Y	Y	
Traffic Vol, veh/h	3	6	7	655	584	0
Future Vol, veh/h	3	6	7	655	584	0
Conflicting Peds, #/hr	0	0	1	0	0	1
Sign Control	Stop	Stop	Free	Free	Free	Free
RT Channelized	-	None	-	None	-	None
Storage Length	0	-	-	-	-	-
Veh in Median Storage, #	0	-	-	0	0	-
Grade, %	0	-	-	0	0	-
Peak Hour Factor	93	93	93	93	93	93
Heavy Vehicles, %	2	2	2	2	2	2
Mvmt Flow	3	6	8	704	628	0

Major/Minor	Minor2	Major1		Major2	
Conflicting Flow All	1348	629	629	0	0
Stage 1	629	-	-	-	-
Stage 2	719	-	-	-	-
Critical Hdwy	6.42	6.22	4.12	-	-
Critical Hdwy Stg 1	5.42	-	-	-	-
Critical Hdwy Stg 2	5.42	-	-	-	-
Follow-up Hdwy	3.518	3.318	2.218	-	-
Pot Cap-1 Maneuver	166	482	953	-	-
Stage 1	531	-	-	-	-
Stage 2	483	-	-	-	-
Platoon blocked, %				-	-
Mov Cap-1 Maneuver	163	482	953	-	-
Mov Cap-2 Maneuver	163	-	-	-	-
Stage 1	530	-	-	-	-
Stage 2	476	-	-	-	-

Approach	EB	NB	SB
HCM Control Delay, s	17.8	0.1	0
HCM LOS	C		

Minor Lane/Major Mvmt	NBL	NBT	EBLn1	SBT	SBR
Capacity (veh/h)	953	-	292	-	-
HCM Lane V/C Ratio	0.008	-	0.033	-	-
HCM Control Delay (s)	8.8	0	17.8	-	-
HCM Lane LOS	A	A	C	-	-
HCM 95th %tile Q(veh)	0	-	0.1	-	-

Intersection

Int Delay, s/veh 0.4

Movement	WBL	WBR	NBT	NBR	SBL	SBT
Lane Configurations	Y		↑	↑		↑
Traffic Vol, veh/h	11	5	732	18	5	923
Future Vol, veh/h	11	5	732	18	5	923
Conflicting Peds, #/hr	0	0	0	1	1	0
Sign Control	Stop	Stop	Free	Free	Free	Free
RT Channelized	-	None	-	None	-	None
Storage Length	0	-	-	125	-	-
Veh in Median Storage, #	0	-	0	-	-	0
Grade, %	0	-	0	-	-	0
Peak Hour Factor	95	95	95	95	95	95
Heavy Vehicles, %	0	0	2	0	0	2
Mvmt Flow	12	5	771	19	5	972

Major/Minor	Minor1		Major1		Major2	
Conflicting Flow All	1754	772	0	0	772	0
Stage 1	772	-	-	-	-	-
Stage 2	982	-	-	-	-	-
Critical Hdwy	6.4	6.2	-	-	4.1	-
Critical Hdwy Stg 1	5.4	-	-	-	-	-
Critical Hdwy Stg 2	5.4	-	-	-	-	-
Follow-up Hdwy	3.5	3.3	-	-	2.2	-
Pot Cap-1 Maneuver	95	403	-	-	852	-
Stage 1	459	-	-	-	-	-
Stage 2	366	-	-	-	-	-
Platoon blocked, %			-	-		
Mov Cap-1 Maneuver	94	403	-	-	852	-
Mov Cap-2 Maneuver	94	-	-	-	-	-
Stage 1	459	-	-	-	-	-
Stage 2	361	-	-	-	-	-

Approach	WB		NB		SB
HCM Control Delay, s	38.5		0		0
HCM LOS	E				

Minor Lane/Major Mvmt	NBT	NBRWBLn1	SBL	SBT
Capacity (veh/h)	-	- 124	852	-
HCM Lane V/C Ratio	-	- 0.136	0.006	-
HCM Control Delay (s)	-	- 38.5	9.3	0
HCM Lane LOS	-	- E	A	A
HCM 95th %tile Q(veh)	-	- 0.5	0	-

Intersection

Int Delay, s/veh 0.3

Movement	EBL	EBT	EBR	WBL	WBT	WBR	NBL	NBT	NBR	SBL	SBT	SBR
Lane Configurations		↔			↔		↑	↑		↑	↑	
Traffic Vol, veh/h	5	0	4	1	0	2	0	744	0	1	919	4
Future Vol, veh/h	5	0	4	1	0	2	0	744	0	1	919	4
Conflicting Peds, #/hr	5	0	0	0	0	5	0	0	4	4	0	0
Sign Control	Stop	Stop	Stop	Stop	Stop	Stop	Free	Free	Free	Free	Free	Free
RT Channelized	-	-	None	-	-	None	-	-	None	-	-	None
Storage Length	-	-	-	-	-	-	65	-	-	50	-	-
Veh in Median Storage, #	-	0	-	-	0	-	-	0	-	-	0	-
Grade, %	-	0	-	-	0	-	-	0	-	-	0	-
Peak Hour Factor	94	94	94	94	94	94	94	94	94	94	94	94
Heavy Vehicles, %	0	0	0	0	0	0	0	2	0	0	1	0
Mvmt Flow	5	0	4	1	0	2	0	791	0	1	978	4

Major/Minor	Minor2			Minor1			Major1			Major2		
Conflicting Flow All	1780	1777	980	1779	1779	800	982	0	0	795	0	0
Stage 1	982	982	-	795	795	-	-	-	-	-	-	-
Stage 2	798	795	-	984	984	-	-	-	-	-	-	-
Critical Hdwy	7.1	6.5	6.2	7.1	6.5	6.2	4.1	-	-	4.1	-	-
Critical Hdwy Stg 1	6.1	5.5	-	6.1	5.5	-	-	-	-	-	-	-
Critical Hdwy Stg 2	6.1	5.5	-	6.1	5.5	-	-	-	-	-	-	-
Follow-up Hdwy	3.5	4	3.3	3.5	4	3.3	2.2	-	-	2.2	-	-
Pot Cap-1 Maneuver	65	83	306	65	83	388	711	-	-	835	-	-
Stage 1	302	330	-	384	402	-	-	-	-	-	-	-
Stage 2	382	402	-	302	329	-	-	-	-	-	-	-
Platoon blocked, %												
Mov Cap-1 Maneuver	64	83	306	64	83	385	711	-	-	831	-	-
Mov Cap-2 Maneuver	64	83	-	64	83	-	-	-	-	-	-	-
Stage 1	302	330	-	383	400	-	-	-	-	-	-	-
Stage 2	378	400	-	297	329	-	-	-	-	-	-	-

Approach	EB	WB	NB	SB
HCM Control Delay, s	45.2	30.6	0	0
HCM LOS	E	D		

Minor Lane/Major Mvmt	NBL	NBT	NBR	EBLn1WBLn1	SBL	SBT	SBR
Capacity (veh/h)	711	-	-	99	144	831	-
HCM Lane V/C Ratio	-	-	-	0.097	0.022	0.001	-
HCM Control Delay (s)	0	-	-	45.2	30.6	9.3	-
HCM Lane LOS	A	-	-	E	D	A	-
HCM 95th %tile Q(veh)	0	-	-	0.3	0.1	0	-

Intersection

Int Delay, s/veh 0.2

Movement	WBL	WBR	NBT	NBR	SBL	SBT
Lane Configurations	Y		P		T	T
Traffic Vol, veh/h	0	5	739	0	18	912
Future Vol, veh/h	0	5	739	0	18	912
Conflicting Peds, #/hr	0	0	0	2	2	0
Sign Control	Stop	Stop	Free	Free	Free	Free
RT Channelized	-	None	-	None	-	None
Storage Length	0	-	-	-	65	-
Veh in Median Storage, #	0	-	0	-	-	0
Grade, %	0	-	0	-	-	0
Peak Hour Factor	96	96	96	96	96	96
Heavy Vehicles, %	0	0	2	0	0	2
Mvmt Flow	0	5	770	0	19	950

Major/Minor	Minor1		Major1		Major2	
Conflicting Flow All	1760	772	0	0	772	0
Stage 1	772	-	-	-	-	-
Stage 2	988	-	-	-	-	-
Critical Hdwy	6.4	6.2	-	-	4.1	-
Critical Hdwy Stg 1	5.4	-	-	-	-	-
Critical Hdwy Stg 2	5.4	-	-	-	-	-
Follow-up Hdwy	3.5	3.3	-	-	2.2	-
Pot Cap-1 Maneuver	94	403	-	-	852	-
Stage 1	459	-	-	-	-	-
Stage 2	364	-	-	-	-	-
Platoon blocked, %			-	-		
Mov Cap-1 Maneuver	92	402	-	-	852	-
Mov Cap-2 Maneuver	92	-	-	-	-	-
Stage 1	458	-	-	-	-	-
Stage 2	356	-	-	-	-	-

Approach	WB		NB		SB
HCM Control Delay, s	14.1		0		0.2
HCM LOS	B				

Minor Lane/Major Mvmt	NBT	NBRWBLn1	SBL	SBT
Capacity (veh/h)	-	- 402	852	-
HCM Lane V/C Ratio	-	- 0.013	0.022	-
HCM Control Delay (s)	-	- 14.1	9.3	-
HCM Lane LOS	-	- B	A	-
HCM 95th %tile Q(veh)	-	- 0	0.1	-

Intersection

Int Delay, s/veh 6.3

Movement	WBL	WBR	NBT	NBR	SBL	SBT
Lane Configurations	Y		P			A
Traffic Vol, veh/h	4	6	1	6	19	0
Future Vol, veh/h	4	6	1	6	19	0
Conflicting Peds, #/hr	1	0	0	5	5	0
Sign Control	Stop	Stop	Free	Free	Free	Free
RT Channelized	-	None	-	None	-	None
Storage Length	0	-	-	-	-	-
Veh in Median Storage, #	0	-	0	-	-	0
Grade, %	0	-	0	-	-	0
Peak Hour Factor	75	75	75	75	75	75
Heavy Vehicles, %	0	17	0	0	0	0
Mvmt Flow	5	8	1	8	25	0

Major/Minor	Minor1		Major1		Major2	
Conflicting Flow All	62	10	0	0	14	0
Stage 1	10	-	-	-	-	-
Stage 2	52	-	-	-	-	-
Critical Hdwy	6.4	6.37	-	-	4.1	-
Critical Hdwy Stg 1	5.4	-	-	-	-	-
Critical Hdwy Stg 2	5.4	-	-	-	-	-
Follow-up Hdwy	3.5	3.453	-	-	2.2	-
Pot Cap-1 Maneuver	949	1029	-	-	1617	-
Stage 1	1018	-	-	-	-	-
Stage 2	976	-	-	-	-	-
Platoon blocked, %			-	-		-
Mov Cap-1 Maneuver	929	1024	-	-	1617	-
Mov Cap-2 Maneuver	929	-	-	-	-	-
Stage 1	1013	-	-	-	-	-
Stage 2	960	-	-	-	-	-

Approach	WB		NB		SB
HCM Control Delay, s	8.7		0		7.3
HCM LOS	A				

Minor Lane/Major Mvmt	NBT	NBRWBLn1	SBL	SBT
Capacity (veh/h)	-	- 984	1617	-
HCM Lane V/C Ratio	-	- 0.014	0.016	-
HCM Control Delay (s)	-	- 8.7	7.3	0
HCM Lane LOS	-	- A	A	A
HCM 95th %tile Q(veh)	-	- 0	0	-

Intersection

Int Delay, s/veh 2

Movement	EBT	EBR	WBL	WBT	NBL	NBR
Lane Configurations	↔		↔		↔	
Traffic Vol, veh/h	8	16	1	4	7	0
Future Vol, veh/h	8	16	1	4	7	0
Conflicting Peds, #/hr	0	3	3	0	1	0
Sign Control	Free	Free	Free	Free	Stop	Stop
RT Channelized	-	None	-	None	-	None
Storage Length	-	-	-	-	0	-
Veh in Median Storage, #	0	-	-	0	0	-
Grade, %	0	-	-	0	0	-
Peak Hour Factor	69	69	69	69	69	69
Heavy Vehicles, %	0	0	0	0	29	0
Mvmt Flow	12	23	1	6	10	0

Major/Minor	Major1	Major2	Minor1
Conflicting Flow All	0	38	36
Stage 1	-	-	26
Stage 2	-	-	10
Critical Hdwy	-	4.1	7.39
Critical Hdwy Stg 1	-	-	6.39
Critical Hdwy Stg 2	-	-	6.39
Follow-up Hdwy	-	2.2	3.761
Pot Cap-1 Maneuver	-	1585	906
Stage 1	-	-	926
Stage 2	-	-	945
Platoon blocked, %	-	-	-
Mov Cap-1 Maneuver	-	1585	902
Mov Cap-2 Maneuver	-	-	902
Stage 1	-	-	926
Stage 2	-	-	943

Approach	EB	WB	NB
HCM Control Delay, s	0	1.5	9
HCM LOS			A

Minor Lane/Major Mvmt	NBLn1	EBT	EBR	WBL	WBT
Capacity (veh/h)	902	-	-	1585	-
HCM Lane V/C Ratio	0.011	-	-	0.001	-
HCM Control Delay (s)	9	-	-	7.3	0
HCM Lane LOS	A	-	-	A	A
HCM 95th %tile Q(veh)	0	-	-	0	-

Intersection

Int Delay, s/veh 1

Movement	EBL	EBT	EBR	WBL	WBT	WBR	NBL	NBT	NBR	SBL	SBT	SBR
Lane Configurations		↔			↔		↑	↑		↑	↑	
Traffic Vol, veh/h	7	0	7	7	0	17	10	716	7	28	873	5
Future Vol, veh/h	7	0	7	7	0	17	10	716	7	28	873	5
Conflicting Peds, #/hr	0	0	0	0	0	0	0	0	2	2	0	0
Sign Control	Stop	Stop	Stop	Stop	Stop	Stop	Free	Free	Free	Free	Free	Free
RT Channelized	-	-	None	-	-	None	-	-	None	-	-	None
Storage Length	-	-	-	-	-	-	125	-	-	125	-	-
Veh in Median Storage, #	-	0	-	-	0	-	-	0	-	-	0	-
Grade, %	-	0	-	-	0	-	-	0	-	-	0	-
Peak Hour Factor	96	96	96	96	96	96	96	96	96	96	96	96
Heavy Vehicles, %	0	0	0	0	0	0	0	2	14	7	2	0
Mvmt Flow	7	0	7	7	0	18	10	746	7	29	909	5

Major/Minor	Minor2			Minor1			Major1			Major2		
Conflicting Flow All	1749	1746	912	1746	1745	751	915	0	0	755	0	0
Stage 1	970	970	-	772	772	-	-	-	-	-	-	-
Stage 2	779	776	-	974	973	-	-	-	-	-	-	-
Critical Hdwy	7.1	6.5	6.2	7.1	6.5	6.2	4.1	-	-	4.17	-	-
Critical Hdwy Stg 1	6.1	5.5	-	6.1	5.5	-	-	-	-	-	-	-
Critical Hdwy Stg 2	6.1	5.5	-	6.1	5.5	-	-	-	-	-	-	-
Follow-up Hdwy	3.5	4	3.3	3.5	4	3.3	2.2	-	-	2.263	-	-
Pot Cap-1 Maneuver	68	87	335	68	87	414	754	-	-	833	-	-
Stage 1	307	334	-	395	412	-	-	-	-	-	-	-
Stage 2	392	410	-	305	333	-	-	-	-	-	-	-
Platoon blocked, %												
Mov Cap-1 Maneuver	63	83	335	64	83	413	754	-	-	833	-	-
Mov Cap-2 Maneuver	63	83	-	64	83	-	-	-	-	-	-	-
Stage 1	303	322	-	389	406	-	-	-	-	-	-	-
Stage 2	370	404	-	288	321	-	-	-	-	-	-	-

Approach	EB	WB	NB	SB
HCM Control Delay, s	44.3	31.8	0.1	0.3
HCM LOS	E	D		

Minor Lane/Major Mvmt	NBL	NBT	NBR	EBLn1	WBLn1	SBL	SBT	SBR
Capacity (veh/h)	754	-	-	106	159	833	-	-
HCM Lane V/C Ratio	0.014	-	-	0.138	0.157	0.035	-	-
HCM Control Delay (s)	9.8	-	-	44.3	31.8	9.5	-	-
HCM Lane LOS	A	-	-	E	D	A	-	-
HCM 95th %tile Q(veh)	0	-	-	0.5	0.5	0.1	-	-

Intersection

Int Delay, s/veh 3.3

Movement	EBL	EBT	EBR	WBL	WBT	WBR	NBL	NBT	NBR	SBL	SBT	SBR
Lane Configurations		↔			↔		↔	↔		↔	↔	
Traffic Vol, veh/h	3	0	3	32	0	13	5	721	42	17	867	10
Future Vol, veh/h	3	0	3	32	0	13	5	721	42	17	867	10
Conflicting Peds, #/hr	1	0	0	0	0	1	1	0	0	0	0	1
Sign Control	Stop	Stop	Stop	Stop	Stop	Stop	Free	Free	Free	Free	Free	Free
RT Channelized	-	-	None	-	-	None	-	-	None	-	-	None
Storage Length	-	-	-	-	-	-	80	-	-	125	-	-
Veh in Median Storage, #	-	0	-	-	0	-	-	0	-	-	0	-
Grade, %	-	0	-	-	0	-	-	0	-	-	0	-
Peak Hour Factor	91	91	91	91	91	91	91	91	91	91	91	91
Heavy Vehicles, %	2	2	2	2	2	2	2	2	2	2	2	2
Mvmt Flow	3	0	3	35	0	14	5	792	46	19	953	11

Major/Minor	Minor2			Minor1			Major1			Major2		
Conflicting Flow All	1832	1846	959	1823	1828	816	965	0	0	838	0	0
Stage 1	997	997	-	826	826	-	-	-	-	-	-	-
Stage 2	835	849	-	997	1002	-	-	-	-	-	-	-
Critical Hdwy	7.12	6.52	6.22	7.12	6.52	6.22	4.12	-	-	4.12	-	-
Critical Hdwy Stg 1	6.12	5.52	-	6.12	5.52	-	-	-	-	-	-	-
Critical Hdwy Stg 2	6.12	5.52	-	6.12	5.52	-	-	-	-	-	-	-
Follow-up Hdwy	3.518	4.018	3.318	3.518	4.018	3.318	2.218	-	-	2.218	-	-
Pot Cap-1 Maneuver	59	75	312	60	77	377	714	-	-	796	-	-
Stage 1	294	322	-	366	387	-	-	-	-	-	-	-
Stage 2	362	377	-	294	320	-	-	-	-	-	-	-
Platoon blocked, %												
Mov Cap-1 Maneuver	55	73	312	58	75	377	714	-	-	795	-	-
Mov Cap-2 Maneuver	55	73	-	58	75	-	-	-	-	-	-	-
Stage 1	292	314	-	363	384	-	-	-	-	-	-	-
Stage 2	346	374	-	284	312	-	-	-	-	-	-	-

Approach	EB	WB	NB	SB
HCM Control Delay, s	46.2	112.6	0.1	0.2
HCM LOS	E	F		

Minor Lane/Major Mvmt	NBL	NBT	NBR	EBLn1	WBLn1	SBL	SBT	SBR
Capacity (veh/h)	714	-	-	94	77	795	-	-
HCM Lane V/C Ratio	0.008	-	-	0.07	0.642	0.023	-	-
HCM Control Delay (s)	10.1	-	-	46.2	112.6	9.6	-	-
HCM Lane LOS	B	-	-	E	F	A	-	-
HCM 95th %tile Q(veh)	0	-	-	0.2	2.9	0.1	-	-

Intersection

Int Delay, s/veh 3.9

Movement	EBL	EBT	EBR	WBL	WBT	WBR	NBL	NBT	NBR	SBL	SBT	SBR
Lane Configurations		↕			↕			↕			↕	
Traffic Vol, veh/h	13	35	2	0	34	4	9	7	6	3	8	12
Future Vol, veh/h	13	35	2	0	34	4	9	7	6	3	8	12
Conflicting Peds, #/hr	2	0	1	1	0	2	0	0	0	0	0	0
Sign Control	Free	Free	Free	Free	Free	Free	Stop	Stop	Stop	Stop	Stop	Stop
RT Channelized	-	-	None	-	-	None	-	-	None	-	-	None
Storage Length	-	-	-	-	-	-	-	-	-	-	-	-
Veh in Median Storage, #	-	0	-	-	0	-	-	0	-	-	0	-
Grade, %	-	0	-	-	0	-	-	0	-	-	0	-
Peak Hour Factor	79	79	79	79	79	79	79	79	79	79	79	79
Heavy Vehicles, %	0	3	0	0	0	0	0	0	0	33	0	0
Mvmt Flow	16	44	3	0	43	5	11	9	8	4	10	15

Major/Minor	Major1	Major2	Minor1	Minor2								
Conflicting Flow All	50	0	0	48	0	0	137	129	47	135	129	48
Stage 1	-	-	-	-	-	-	79	79	-	48	48	-
Stage 2	-	-	-	-	-	-	58	50	-	87	81	-
Critical Hdwy	4.1	-	-	4.1	-	-	7.1	6.5	6.2	7.43	6.5	6.2
Critical Hdwy Stg 1	-	-	-	-	-	-	6.1	5.5	-	6.43	5.5	-
Critical Hdwy Stg 2	-	-	-	-	-	-	6.1	5.5	-	6.43	5.5	-
Follow-up Hdwy	2.2	-	-	2.2	-	-	3.5	4	3.3	3.797	4	3.3
Pot Cap-1 Maneuver	1570	-	-	1572	-	-	838	765	1028	770	765	1027
Stage 1	-	-	-	-	-	-	935	833	-	892	859	-
Stage 2	-	-	-	-	-	-	959	857	-	849	832	-
Platoon blocked, %	-	-	-	-	-	-	-	-	-	-	-	-
Mov Cap-1 Maneuver	1570	-	-	1572	-	-	810	755	1027	750	755	1025
Mov Cap-2 Maneuver	-	-	-	-	-	-	810	755	-	750	755	-
Stage 1	-	-	-	-	-	-	925	824	-	881	857	-
Stage 2	-	-	-	-	-	-	934	855	-	825	823	-

Approach	EB	WB	NB	SB
HCM Control Delay, s	1.9	0	9.4	9.3
HCM LOS			A	A

Minor Lane/Major Mvmt	NBLn1	EBL	EBT	EBR	WBL	WBT	WBR	SBLn1
Capacity (veh/h)	839	1570	-	-	1572	-	-	874
HCM Lane V/C Ratio	0.033	0.01	-	-	-	-	-	0.033
HCM Control Delay (s)	9.4	7.3	0	-	0	-	-	9.3
HCM Lane LOS	A	A	A	-	A	-	-	A
HCM 95th %tile Q(veh)	0.1	0	-	-	0	-	-	0.1

Intersection												
Int Delay, s/veh	7.5											
Movement	EBL	EBT	EBR	WBL	WBT	WBR	NBL	NBT	NBR	SBL	SBT	SBR
Lane Configurations		↕			↕			↕			↕	
Traffic Vol, veh/h	0	39	3	9	33	2	4	6	5	15	12	2
Future Vol, veh/h	0	39	3	9	33	2	4	6	5	15	12	2
Conflicting Peds, #/hr	3	0	0	0	0	3	3	0	2	2	0	3
Sign Control	Stop	Stop	Stop	Stop	Stop	Stop	Free	Free	Free	Free	Free	Free
RT Channelized	-	-	None	-	-	None	-	-	None	-	-	None
Storage Length	-	-	-	-	-	-	-	-	-	-	-	-
Veh in Median Storage, #	-	0	-	-	0	-	-	0	-	-	0	-
Grade, %	-	0	-	-	0	-	-	0	-	-	0	-
Peak Hour Factor	86	86	86	86	86	86	86	86	86	86	86	86
Heavy Vehicles, %	0	5	0	22	0	0	0	0	0	0	8	0
Mvmt Flow	0	45	3	10	38	2	5	7	6	17	14	2
Major/Minor	Minor2			Minor1			Major1			Major2		
Conflicting Flow All	96	77	18	95	75	15	19	0	0	15	0	0
Stage 1	53	53	-	21	21	-	-	-	-	-	-	-
Stage 2	43	24	-	74	54	-	-	-	-	-	-	-
Critical Hdwy	7.1	6.55	6.2	7.32	6.5	6.2	4.1	-	-	4.1	-	-
Critical Hdwy Stg 1	6.1	5.55	-	6.32	5.5	-	-	-	-	-	-	-
Critical Hdwy Stg 2	6.1	5.55	-	6.32	5.5	-	-	-	-	-	-	-
Follow-up Hdwy	3.5	4.045	3.3	3.698	4	3.3	2.2	-	-	2.2	-	-
Pot Cap-1 Maneuver	891	808	1066	842	819	1070	1611	-	-	1616	-	-
Stage 1	965	845	-	948	882	-	-	-	-	-	-	-
Stage 2	976	869	-	888	854	-	-	-	-	-	-	-
Platoon blocked, %												
Mov Cap-1 Maneuver	843	793	1063	793	804	1065	1611	-	-	1611	-	-
Mov Cap-2 Maneuver	843	793	-	793	804	-	-	-	-	-	-	-
Stage 1	959	833	-	943	878	-	-	-	-	-	-	-
Stage 2	926	865	-	828	842	-	-	-	-	-	-	-
Approach	EB			WB			NB			SB		
HCM Control Delay, s	9.7			9.7			1.9			3.8		
HCM LOS	A			A								
Minor Lane/Major Mvmt	NBL	NBT	NBR	EBLn1	WBLn1	SBL	SBT	SBR				
Capacity (veh/h)	1611	-	-	808	811	1611	-	-				
HCM Lane V/C Ratio	0.003	-	-	0.06	0.063	0.011	-	-				
HCM Control Delay (s)	7.2	0	-	9.7	9.7	7.3	0	-				
HCM Lane LOS	A	A	-	A	A	A	A	-				
HCM 95th %tile Q(veh)	0	-	-	0.2	0.2	0	-	-				

Intersection	
Intersection Delay, s/veh	7.3
Intersection LOS	A

Movement	EBU	EBL	EBT	EBR	WBU	WBL	WBT	WBR	NBU	NBL	NBT	NBR
Lane Configurations			↕				↕				↕	
Traffic Vol, veh/h	0	2	53	6	0	1	32	0	0	5	2	3
Future Vol, veh/h	0	2	53	6	0	1	32	0	0	5	2	3
Peak Hour Factor	0.92	0.75	0.75	0.75	0.92	0.75	0.75	0.75	0.92	0.75	0.75	0.75
Heavy Vehicles, %	2	0	4	0	2	0	0	0	2	40	0	0
Mvmt Flow	0	3	71	8	0	1	43	0	0	7	3	4
Number of Lanes	0	0	1	0	0	0	1	0	0	0	1	0

Approach	EB	WB	NB
Opposing Approach	WB	EB	SB
Opposing Lanes	1	1	1
Conflicting Approach Left	SB	NB	EB
Conflicting Lanes Left	1	1	1
Conflicting Approach Right	NB	SB	WB
Conflicting Lanes Right	1	1	1
HCM Control Delay	7.3	7.2	7.9
HCM LOS	A	A	A

Lane	NBLn1	EBLn1	WBLn1	SBLn1
Vol Left, %	50%	3%	3%	0%
Vol Thru, %	20%	87%	97%	0%
Vol Right, %	30%	10%	0%	100%
Sign Control	Stop	Stop	Stop	Stop
Traffic Vol by Lane	10	61	33	4
LT Vol	5	2	1	0
Through Vol	2	53	32	0
RT Vol	3	6	0	4
Lane Flow Rate	13	81	44	5
Geometry Grp	1	1	1	1
Degree of Util (X)	0.017	0.088	0.049	0.005
Departure Headway (Hd)	4.721	3.914	4	3.525
Convergence, Y/N	Yes	Yes	Yes	Yes
Cap	755	917	895	1006
Service Time	2.771	1.932	2.023	1.579
HCM Lane V/C Ratio	0.017	0.088	0.049	0.005
HCM Control Delay	7.9	7.3	7.2	6.6
HCM Lane LOS	A	A	A	A
HCM 95th-tile Q	0.1	0.3	0.2	0

Intersection

Intersection Delay, s/veh
 Intersection LOS

Movement	SBU	SBL	SBT	SBR
Lane Configurations			↕	
Traffic Vol, veh/h	0	0	0	4
Future Vol, veh/h	0	0	0	4
Peak Hour Factor	0.92	0.75	0.75	0.75
Heavy Vehicles, %	2	0	0	0
Mvmt Flow	0	0	0	5
Number of Lanes	0	0	1	0

Approach	SB
Opposing Approach	NB
Opposing Lanes	1
Conflicting Approach Left	WB
Conflicting Lanes Left	1
Conflicting Approach Right	EB
Conflicting Lanes Right	1
HCM Control Delay	6.6
HCM LOS	A

Intersection

Int Delay, s/veh 0.1

Movement	EBL	EBR	NBL	NBT	SBT	SBR
Lane Configurations	Y			Y	Y	
Traffic Vol, veh/h	1	2	8	752	896	1
Future Vol, veh/h	1	2	8	752	896	1
Conflicting Peds, #/hr	0	0	0	0	0	0
Sign Control	Stop	Stop	Free	Free	Free	Free
RT Channelized	-	None	-	None	-	None
Storage Length	0	-	-	-	-	-
Veh in Median Storage, #	0	-	-	0	0	-
Grade, %	0	-	-	0	0	-
Peak Hour Factor	91	91	91	91	91	92
Heavy Vehicles, %	2	2	2	2	2	2
Mvmt Flow	1	2	9	826	985	1

Major/Minor	Minor2	Major1		Major2	
Conflicting Flow All	1829	985	986	0	- 0
Stage 1	985	-	-	-	- -
Stage 2	844	-	-	-	- -
Critical Hdwy	6.42	6.22	4.12	-	- -
Critical Hdwy Stg 1	5.42	-	-	-	- -
Critical Hdwy Stg 2	5.42	-	-	-	- -
Follow-up Hdwy	3.518	3.318	2.218	-	- -
Pot Cap-1 Maneuver	84	301	701	-	- -
Stage 1	362	-	-	-	- -
Stage 2	422	-	-	-	- -
Platoon blocked, %				-	- -
Mov Cap-1 Maneuver	82	301	701	-	- -
Mov Cap-2 Maneuver	82	-	-	-	- -
Stage 1	362	-	-	-	- -
Stage 2	412	-	-	-	- -

Approach	EB	NB	SB
HCM Control Delay, s	28.1	0.1	0
HCM LOS	D		

Minor Lane/Major Mvmt	NBL	NBT	EBLn1	SBT	SBR
Capacity (veh/h)	701	-	159	-	-
HCM Lane V/C Ratio	0.013	-	0.021	-	-
HCM Control Delay (s)	10.2	0	28.1	-	-
HCM Lane LOS	B	A	D	-	-
HCM 95th %tile Q(veh)	0	-	0.1	-	-

Intersection

Int Delay, s/veh 0.2

Movement	WBL	WBR	NBT	NBR	SBL	SBT
Lane Configurations	↘		↑	↗		↖
Traffic Vol, veh/h	7	3	756	9	4	972
Future Vol, veh/h	7	3	756	9	4	972
Conflicting Peds, #/hr	0	0	0	1	1	0
Sign Control	Stop	Stop	Free	Free	Free	Free
RT Channelized	-	None	-	None	-	None
Storage Length	0	-	-	125	-	-
Veh in Median Storage, #	0	-	0	-	-	0
Grade, %	0	-	0	-	-	0
Peak Hour Factor	96	96	96	96	96	96
Heavy Vehicles, %	0	0	2	0	0	1
Mvmt Flow	7	3	788	9	4	1013

Major/Minor	Minor1		Major1		Major2	
Conflicting Flow All	1810	789	0	0	789	0
Stage 1	789	-	-	-	-	-
Stage 2	1021	-	-	-	-	-
Critical Hdwy	6.4	6.2	-	-	4.1	-
Critical Hdwy Stg 1	5.4	-	-	-	-	-
Critical Hdwy Stg 2	5.4	-	-	-	-	-
Follow-up Hdwy	3.5	3.3	-	-	2.2	-
Pot Cap-1 Maneuver	88	394	-	-	840	-
Stage 1	451	-	-	-	-	-
Stage 2	351	-	-	-	-	-
Platoon blocked, %			-	-		
Mov Cap-1 Maneuver	87	394	-	-	840	-
Mov Cap-2 Maneuver	87	-	-	-	-	-
Stage 1	451	-	-	-	-	-
Stage 2	347	-	-	-	-	-

Approach	WB		NB		SB
HCM Control Delay, s	39.7		0		0
HCM LOS	E				

Minor Lane/Major Mvmt	NBT	NBRWBLn1	SBL	SBT
Capacity (veh/h)	-	- 114	840	-
HCM Lane V/C Ratio	-	- 0.091	0.005	-
HCM Control Delay (s)	-	- 39.7	9.3	0
HCM Lane LOS	-	- E	A	A
HCM 95th %tile Q(veh)	-	- 0.3	0	-

Intersection

Int Delay, s/veh 0

Movement	EBL	EBT	EBR	WBL	WBT	WBR	NBL	NBT	NBR	SBL	SBT	SBR
Lane Configurations		↕			↕		↕	↕		↕	↕	
Traffic Vol, veh/h	0	0	0	1	0	1	2	755	0	1	981	4
Future Vol, veh/h	0	0	0	1	0	1	2	755	0	1	981	4
Conflicting Peds, #/hr	0	0	1	1	0	0	0	0	3	3	0	0
Sign Control	Stop	Stop	Stop	Stop	Stop	Stop	Free	Free	Free	Free	Free	Free
RT Channelized	-	-	None	-	-	None	-	-	None	-	-	None
Storage Length	-	-	-	-	-	-	65	-	-	50	-	-
Veh in Median Storage, #	-	0	-	-	0	-	-	0	-	-	0	-
Grade, %	-	0	-	-	0	-	-	0	-	-	0	-
Peak Hour Factor	96	96	96	96	96	96	96	96	96	96	96	96
Heavy Vehicles, %	0	0	0	0	0	0	0	3	0	0	2	0
Mvmt Flow	0	0	0	1	0	1	2	786	0	1	1022	4

Major/Minor	Minor2			Minor1			Major1			Major2		
Conflicting Flow All	1817	1820	1025	1821	1822	789	1026	0	0	789	0	0
Stage 1	1026	1026	-	794	794	-	-	-	-	-	-	-
Stage 2	791	794	-	1027	1028	-	-	-	-	-	-	-
Critical Hdwy	7.1	6.5	6.2	7.1	6.5	6.2	4.1	-	-	4.1	-	-
Critical Hdwy Stg 1	6.1	5.5	-	6.1	5.5	-	-	-	-	-	-	-
Critical Hdwy Stg 2	6.1	5.5	-	6.1	5.5	-	-	-	-	-	-	-
Follow-up Hdwy	3.5	4	3.3	3.5	4	3.3	2.2	-	-	2.2	-	-
Pot Cap-1 Maneuver	61	78	288	60	78	394	685	-	-	840	-	-
Stage 1	286	315	-	384	403	-	-	-	-	-	-	-
Stage 2	386	403	-	285	314	-	-	-	-	-	-	-
Platoon blocked, %												
Mov Cap-1 Maneuver	61	77	288	60	77	393	684	-	-	840	-	-
Mov Cap-2 Maneuver	61	77	-	60	77	-	-	-	-	-	-	-
Stage 1	285	315	-	382	401	-	-	-	-	-	-	-
Stage 2	384	401	-	284	314	-	-	-	-	-	-	-

Approach	EB	WB	NB	SB
HCM Control Delay, s	0	40.3	0	0
HCM LOS	A	E		

Minor Lane/Major Mvmt	NBL	NBT	NBR	EBLn1WBLn1	SBL	SBT	SBR
Capacity (veh/h)	684	-	-	-	104	840	-
HCM Lane V/C Ratio	0.003	-	-	-	0.02	0.001	-
HCM Control Delay (s)	10.3	-	-	0	40.3	9.3	-
HCM Lane LOS	B	-	-	A	E	A	-
HCM 95th %tile Q(veh)	0	-	-	-	0.1	0	-

Intersection

Int Delay, s/veh 0.2

Movement	WBL	WBR	NBT	NBR	SBL	SBT
Lane Configurations	Y		P		T	T
Traffic Vol, veh/h	0	11	749	0	8	973
Future Vol, veh/h	0	11	749	0	8	973
Conflicting Peds, #/hr	0	0	0	1	1	0
Sign Control	Stop	Stop	Free	Free	Free	Free
RT Channelized	-	None	-	None	-	None
Storage Length	0	-	-	-	65	-
Veh in Median Storage, #	0	-	0	-	-	0
Grade, %	0	-	0	-	-	0
Peak Hour Factor	93	93	93	93	93	93
Heavy Vehicles, %	0	9	2	0	0	1
Mvmt Flow	0	12	805	0	9	1046

Major/Minor	Minor1		Major1		Major2	
Conflicting Flow All	1869	806	0	0	806	0
Stage 1	806	-	-	-	-	-
Stage 2	1063	-	-	-	-	-
Critical Hdwy	6.4	6.29	-	-	4.1	-
Critical Hdwy Stg 1	5.4	-	-	-	-	-
Critical Hdwy Stg 2	5.4	-	-	-	-	-
Follow-up Hdwy	3.5	3.381	-	-	2.2	-
Pot Cap-1 Maneuver	80	371	-	-	828	-
Stage 1	443	-	-	-	-	-
Stage 2	335	-	-	-	-	-
Platoon blocked, %			-	-		-
Mov Cap-1 Maneuver	79	371	-	-	828	-
Mov Cap-2 Maneuver	79	-	-	-	-	-
Stage 1	443	-	-	-	-	-
Stage 2	331	-	-	-	-	-

Approach	WB		NB		SB
HCM Control Delay, s	15		0		0.1
HCM LOS	C				

Minor Lane/Major Mvmt	NBT	NBRWBLn1	SBL	SBT
Capacity (veh/h)	-	- 371	828	-
HCM Lane V/C Ratio	-	- 0.032	0.01	-
HCM Control Delay (s)	-	- 15	9.4	-
HCM Lane LOS	-	- C	A	-
HCM 95th %tile Q(veh)	-	- 0.1	0	-

Intersection

Int Delay, s/veh 6.7

Movement	WBL	WBR	NBT	NBR	SBL	SBT
Lane Configurations	Y		P			A
Traffic Vol, veh/h	3	13	1	2	6	2
Future Vol, veh/h	3	13	1	2	6	2
Conflicting Peds, #/hr	2	0	0	0	0	0
Sign Control	Stop	Stop	Free	Free	Free	Free
RT Channelized	-	None	-	None	-	None
Storage Length	0	-	-	-	-	-
Veh in Median Storage, #	0	-	0	-	-	0
Grade, %	0	-	0	-	-	0
Peak Hour Factor	75	75	75	75	75	75
Heavy Vehicles, %	33	8	0	0	0	0
Mvmt Flow	4	17	1	3	8	3

Major/Minor	Minor1		Major1		Major2	
Conflicting Flow All	24	3	0	0	4	0
Stage 1	3	-	-	-	-	-
Stage 2	21	-	-	-	-	-
Critical Hdwy	6.73	6.28	-	-	4.1	-
Critical Hdwy Stg 1	5.73	-	-	-	-	-
Critical Hdwy Stg 2	5.73	-	-	-	-	-
Follow-up Hdwy	3.797	3.372	-	-	2.2	-
Pot Cap-1 Maneuver	918	1064	-	-	1631	-
Stage 1	945	-	-	-	-	-
Stage 2	927	-	-	-	-	-
Platoon blocked, %			-	-		-
Mov Cap-1 Maneuver	912	1064	-	-	1631	-
Mov Cap-2 Maneuver	912	-	-	-	-	-
Stage 1	945	-	-	-	-	-
Stage 2	921	-	-	-	-	-

Approach	WB		NB		SB
HCM Control Delay, s	8.6		0		5.4
HCM LOS	A				

Minor Lane/Major Mvmt	NBT	NBRWBLn1	SBL	SBT
Capacity (veh/h)	-	- 1032	1631	-
HCM Lane V/C Ratio	-	- 0.021	0.005	-
HCM Control Delay (s)	-	- 8.6	7.2	0
HCM Lane LOS	-	- A	A	A
HCM 95th %tile Q(veh)	-	- 0.1	0	-

Intersection

Int Delay, s/veh 5.9

Movement	EBT	EBR	WBL	WBT	NBL	NBR
Lane Configurations	↔		↔		↔	
Traffic Vol, veh/h	2	5	1	0	13	1
Future Vol, veh/h	2	5	1	0	13	1
Conflicting Peds, #/hr	0	1	1	0	0	0
Sign Control	Free	Free	Free	Free	Stop	Stop
RT Channelized	-	None	-	None	-	None
Storage Length	-	-	-	-	0	-
Veh in Median Storage, #	0	-	-	0	0	-
Grade, %	0	-	-	0	0	-
Peak Hour Factor	79	79	79	79	79	79
Heavy Vehicles, %	0	0	100	0	15	0
Mvmt Flow	3	6	1	0	16	1

Major/Minor	Major1	Major2	Minor1
Conflicting Flow All	0	10	10
Stage 1	-	-	7
Stage 2	-	-	3
Critical Hdwy	-	5.1	6.55
Critical Hdwy Stg 1	-	-	5.55
Critical Hdwy Stg 2	-	-	5.55
Follow-up Hdwy	-	3.1	3.635
Pot Cap-1 Maneuver	-	1150	977
Stage 1	-	-	983
Stage 2	-	-	987
Platoon blocked, %	-	-	-
Mov Cap-1 Maneuver	-	1150	975
Mov Cap-2 Maneuver	-	-	975
Stage 1	-	-	982
Stage 2	-	-	986

Approach	EB	WB	NB
HCM Control Delay, s	0	8.1	8.7
HCM LOS			A

Minor Lane/Major Mvmt	NBLn1	EBT	EBR	WBL	WBT
Capacity (veh/h)	982	-	-	1150	-
HCM Lane V/C Ratio	0.018	-	-	0.001	-
HCM Control Delay (s)	8.7	-	-	8.1	0
HCM Lane LOS	A	-	-	A	A
HCM 95th %tile Q(veh)	0.1	-	-	0	-

Intersection

Int Delay, s/veh 0.8

Movement	EBL	EBT	EBR	WBL	WBT	WBR	NBL	NBT	NBR	SBL	SBT	SBR
Lane Configurations		↔			↔		↑	↑		↑	↑	
Traffic Vol, veh/h	0	0	6	6	1	25	9	728	2	22	943	5
Future Vol, veh/h	0	0	6	6	1	25	9	728	2	22	943	5
Conflicting Peds, #/hr	0	0	0	0	0	0	0	0	1	1	0	0
Sign Control	Stop	Stop	Stop	Stop	Stop	Stop	Free	Free	Free	Free	Free	Free
RT Channelized	-	-	None	-	-	None	-	-	None	-	-	None
Storage Length	-	-	-	-	-	-	125	-	-	125	-	-
Veh in Median Storage, #	-	0	-	-	0	-	-	0	-	-	0	-
Grade, %	-	0	-	-	0	-	-	0	-	-	0	-
Peak Hour Factor	95	95	95	95	95	95	95	95	95	95	95	95
Heavy Vehicles, %	0	0	0	17	0	4	0	3	0	5	1	0
Mvmt Flow	0	0	6	6	1	26	9	766	2	23	993	5

Major/Minor	Minor2			Minor1			Major1			Major2		
Conflicting Flow All	1842	1830	995	1832	1831	768	998	0	0	769	0	0
Stage 1	1042	1042	-	787	787	-	-	-	-	-	-	-
Stage 2	800	788	-	1045	1044	-	-	-	-	-	-	-
Critical Hdwy	7.1	6.5	6.2	7.27	6.5	6.24	4.1	-	-	4.15	-	-
Critical Hdwy Stg 1	6.1	5.5	-	6.27	5.5	-	-	-	-	-	-	-
Critical Hdwy Stg 2	6.1	5.5	-	6.27	5.5	-	-	-	-	-	-	-
Follow-up Hdwy	3.5	4	3.3	3.653	4	3.336	2.2	-	-	2.245	-	-
Pot Cap-1 Maneuver	58	77	300	54	77	398	701	-	-	832	-	-
Stage 1	280	309	-	363	406	-	-	-	-	-	-	-
Stage 2	382	405	-	259	309	-	-	-	-	-	-	-
Platoon blocked, %												
Mov Cap-1 Maneuver	52	74	300	51	74	398	701	-	-	832	-	-
Mov Cap-2 Maneuver	52	74	-	51	74	-	-	-	-	-	-	-
Stage 1	276	300	-	358	400	-	-	-	-	-	-	-
Stage 2	351	399	-	247	300	-	-	-	-	-	-	-

Approach	EB	WB	NB	SB
HCM Control Delay, s	17.3	32.3	0.1	0.2
HCM LOS	C	D		

Minor Lane/Major Mvmt	NBL	NBT	NBR	EBLn1WBLn1	SBL	SBT	SBR
Capacity (veh/h)	701	-	-	300	165	832	-
HCM Lane V/C Ratio	0.014	-	-	0.021	0.204	0.028	-
HCM Control Delay (s)	10.2	-	-	17.3	32.3	9.5	-
HCM Lane LOS	B	-	-	C	D	A	-
HCM 95th %tile Q(veh)	0	-	-	0.1	0.7	0.1	-

Intersection												
Int Delay, s/veh	3.5											
Movement	EBL	EBT	EBR	WBL	WBT	WBR	NBL	NBT	NBR	SBL	SBT	SBR
Lane Configurations		↔			↔		↔	↔		↔	↔	
Traffic Vol, veh/h	6	3	21	23	3	23	28	712	36	7	943	7
Future Vol, veh/h	6	3	21	23	3	23	28	712	36	7	943	7
Conflicting Peds, #/hr	1	0	0	0	0	1	0	0	0	0	0	0
Sign Control	Stop	Stop	Stop	Stop	Stop	Stop	Free	Free	Free	Free	Free	Free
RT Channelized	-	-	None	-	-	None	-	-	None	-	-	None
Storage Length	-	-	-	-	-	-	80	-	-	125	-	-
Veh in Median Storage, #	-	0	-	-	0	-	-	0	-	-	0	-
Grade, %	-	0	-	-	0	-	-	0	-	-	0	-
Peak Hour Factor	95	95	95	95	95	95	95	95	95	95	95	95
Heavy Vehicles, %	2	2	2	2	2	2	2	2	2	2	2	2
Mvmt Flow	6	3	22	24	3	24	29	749	38	7	993	7
Major/Minor	Minor2			Minor1			Major1			Major2		
Conflicting Flow All	1853	1857	996	1851	1842	769	1000	0	0	787	0	0
Stage 1	1011	1011	-	827	827	-	-	-	-	-	-	-
Stage 2	842	846	-	1024	1015	-	-	-	-	-	-	-
Critical Hdwy	7.12	6.52	6.22	7.12	6.52	6.22	4.12	-	-	4.12	-	-
Critical Hdwy Stg 1	6.12	5.52	-	6.12	5.52	-	-	-	-	-	-	-
Critical Hdwy Stg 2	6.12	5.52	-	6.12	5.52	-	-	-	-	-	-	-
Follow-up Hdwy	3.518	4.018	3.318	3.518	4.018	3.318	2.218	-	-	2.218	-	-
Pot Cap-1 Maneuver	57	74	297	57	75	401	692	-	-	832	-	-
Stage 1	289	317	-	366	386	-	-	-	-	-	-	-
Stage 2	359	378	-	284	316	-	-	-	-	-	-	-
Platoon blocked, %												
Mov Cap-1 Maneuver	50	70	297	49	71	401	692	-	-	831	-	-
Mov Cap-2 Maneuver	50	70	-	49	71	-	-	-	-	-	-	-
Stage 1	277	314	-	351	370	-	-	-	-	-	-	-
Stage 2	320	362	-	258	313	-	-	-	-	-	-	-
Approach	EB			WB			NB			SB		
HCM Control Delay, s	42.1			96.1			0.4			0.1		
HCM LOS	E			F								
Minor Lane/Major Mvmt	NBL	NBT	NBR	EBLn1	WBLn1	SBL	SBT	SBR				
Capacity (veh/h)	692	-	-	128	86	831	-	-				
HCM Lane V/C Ratio	0.043	-	-	0.247	0.6	0.009	-	-				
HCM Control Delay (s)	10.4	-	-	42.1	96.1	9.4	-	-				
HCM Lane LOS	B	-	-	E	F	A	-	-				
HCM 95th %tile Q(veh)	0.1	-	-	0.9	2.7	0	-	-				

Intersection

Int Delay, s/veh 4.5

Movement	EBL	EBT	EBR	WBL	WBT	WBR	NBL	NBT	NBR	SBL	SBT	SBR
Lane Configurations		↕			↕			↕			↕	
Traffic Vol, veh/h	25	33	2	5	31	17	10	9	3	6	17	8
Future Vol, veh/h	25	33	2	5	31	17	10	9	3	6	17	8
Conflicting Peds, #/hr	1	0	0	0	0	1	0	0	2	2	0	0
Sign Control	Free	Free	Free	Free	Free	Free	Stop	Stop	Stop	Stop	Stop	Stop
RT Channelized	-	-	None	-	-	None	-	-	None	-	-	None
Storage Length	-	-	-	-	-	-	-	-	-	-	-	-
Veh in Median Storage, #	-	0	-	-	0	-	-	0	-	-	0	-
Grade, %	-	0	-	-	0	-	-	0	-	-	0	-
Peak Hour Factor	83	83	83	83	83	83	83	83	83	83	83	83
Heavy Vehicles, %	0	0	0	0	0	0	0	0	0	0	0	0
Mvmt Flow	30	40	2	6	37	20	12	11	4	7	20	10

Major/Minor	Major1			Major2			Minor1			Minor2		
Conflicting Flow All	59	0	0	42	0	0	176	172	43	171	163	49
Stage 1	-	-	-	-	-	-	101	101	-	61	61	-
Stage 2	-	-	-	-	-	-	75	71	-	110	102	-
Critical Hdwy	4.1	-	-	4.1	-	-	7.1	6.5	6.2	7.1	6.5	6.2
Critical Hdwy Stg 1	-	-	-	-	-	-	6.1	5.5	-	6.1	5.5	-
Critical Hdwy Stg 2	-	-	-	-	-	-	6.1	5.5	-	6.1	5.5	-
Follow-up Hdwy	2.2	-	-	2.2	-	-	3.5	4	3.3	3.5	4	3.3
Pot Cap-1 Maneuver	1558	-	-	1580	-	-	791	725	1033	797	733	1025
Stage 1	-	-	-	-	-	-	910	815	-	955	848	-
Stage 2	-	-	-	-	-	-	939	840	-	900	815	-
Platoon blocked, %	-	-	-	-	-	-	-	-	-	-	-	-
Mov Cap-1 Maneuver	1558	-	-	1577	-	-	752	707	1031	768	715	1024
Mov Cap-2 Maneuver	-	-	-	-	-	-	752	707	-	768	715	-
Stage 1	-	-	-	-	-	-	892	799	-	935	844	-
Stage 2	-	-	-	-	-	-	904	836	-	865	799	-

Approach	EB	WB	NB	SB
HCM Control Delay, s	3.1	0.7	9.9	9.8
HCM LOS			A	A

Minor Lane/Major Mvmt	NBLn1	EBL	EBT	EBR	WBL	WBT	WBR	SBLn1
Capacity (veh/h)	760	1558	-	-	1577	-	-	787
HCM Lane V/C Ratio	0.035	0.019	-	-	0.004	-	-	0.047
HCM Control Delay (s)	9.9	7.4	0	-	7.3	0	-	9.8
HCM Lane LOS	A	A	A	-	A	A	-	A
HCM 95th %tile Q(veh)	0.1	0.1	-	-	0	-	-	0.1

Intersection

Int Delay, s/veh 6.9

Movement	EBL	EBT	EBR	WBL	WBT	WBR	NBL	NBT	NBR	SBL	SBT	SBR
Lane Configurations		↕			↕			↕			↕	
Traffic Vol, veh/h	2	37	3	10	37	2	7	13	7	8	16	3
Future Vol, veh/h	2	37	3	10	37	2	7	13	7	8	16	3
Conflicting Peds, #/hr	4	0	0	0	0	4	1	0	1	1	0	1
Sign Control	Stop	Stop	Stop	Stop	Stop	Stop	Free	Free	Free	Free	Free	Free
RT Channelized	-	-	None	-	-	None	-	-	None	-	-	None
Storage Length	-	-	-	-	-	-	-	-	-	-	-	-
Veh in Median Storage, #	-	0	-	-	0	-	-	0	-	-	0	-
Grade, %	-	0	-	-	0	-	-	0	-	-	0	-
Peak Hour Factor	84	84	84	84	84	84	84	84	84	84	84	84
Heavy Vehicles, %	0	0	0	0	0	0	0	8	14	0	6	0
Mvmt Flow	2	44	4	12	44	2	8	15	8	10	19	4

Major/Minor	Minor2			Minor1			Major1			Major2		
Conflicting Flow All	105	82	22	101	80	25	24	0	0	25	0	0
Stage 1	41	41	-	37	37	-	-	-	-	-	-	-
Stage 2	64	41	-	64	43	-	-	-	-	-	-	-
Critical Hdwy	7.1	6.5	6.2	7.1	6.5	6.2	4.1	-	-	4.1	-	-
Critical Hdwy Stg 1	6.1	5.5	-	6.1	5.5	-	-	-	-	-	-	-
Critical Hdwy Stg 2	6.1	5.5	-	6.1	5.5	-	-	-	-	-	-	-
Follow-up Hdwy	3.5	4	3.3	3.5	4	3.3	2.2	-	-	2.2	-	-
Pot Cap-1 Maneuver	880	812	1061	885	814	1057	1604	-	-	1603	-	-
Stage 1	979	865	-	984	868	-	-	-	-	-	-	-
Stage 2	952	865	-	952	863	-	-	-	-	-	-	-
Platoon blocked, %												
Mov Cap-1 Maneuver	830	802	1060	837	804	1052	1604	-	-	1597	-	-
Mov Cap-2 Maneuver	830	802	-	837	804	-	-	-	-	-	-	-
Stage 1	973	859	-	978	863	-	-	-	-	-	-	-
Stage 2	893	860	-	895	857	-	-	-	-	-	-	-

Approach	EB	WB	NB	SB
HCM Control Delay, s	9.7	9.7	1.9	2.2
HCM LOS	A	A		

Minor Lane/Major Mvmt	NBL	NBT	NBR	EBLn1	WBLn1	SBL	SBT	SBR
Capacity (veh/h)	1604	-	-	818	818	1597	-	-
HCM Lane V/C Ratio	0.005	-	-	0.061	0.071	0.006	-	-
HCM Control Delay (s)	7.3	0	-	9.7	9.7	7.3	0	-
HCM Lane LOS	A	A	-	A	A	A	A	-
HCM 95th %tile Q(veh)	0	-	-	0.2	0.2	0	-	-

Intersection	
Intersection Delay, s/veh	7.2
Intersection LOS	A

Movement	EBU	EBL	EBT	EBR	WBU	WBL	WBT	WBR	NBU	NBL	NBT	NBR
Lane Configurations			↕				↕				↕	
Traffic Vol, veh/h	0	4	45	3	0	2	40	0	0	4	1	4
Future Vol, veh/h	0	4	45	3	0	2	40	0	0	4	1	4
Peak Hour Factor	0.92	0.83	0.83	0.83	0.92	0.83	0.83	0.83	0.92	0.83	0.83	0.83
Heavy Vehicles, %	2	0	2	0	2	0	0	0	2	0	0	0
Mvmt Flow	0	5	54	4	0	2	48	0	0	5	1	5
Number of Lanes	0	0	1	0	0	0	1	0	0	0	1	0

Approach	EB	WB	NB
Opposing Approach	WB	EB	SB
Opposing Lanes	1	1	1
Conflicting Approach Left	SB	NB	EB
Conflicting Lanes Left	1	1	1
Conflicting Approach Right	NB	SB	WB
Conflicting Lanes Right	1	1	1
HCM Control Delay	7.3	7.2	7
HCM LOS	A	A	A

Lane	NBLn1	EBLn1	WBLn1	SBLn1
Vol Left, %	44%	8%	5%	0%
Vol Thru, %	11%	87%	95%	14%
Vol Right, %	44%	6%	0%	86%
Sign Control	Stop	Stop	Stop	Stop
Traffic Vol by Lane	9	52	42	7
LT Vol	4	4	2	0
Through Vol	1	45	40	1
RT Vol	4	3	0	6
Lane Flow Rate	11	63	51	8
Geometry Grp	1	1	1	1
Degree of Util (X)	0.012	0.069	0.056	0.008
Departure Headway (Hd)	3.924	3.952	3.99	3.59
Convergence, Y/N	Yes	Yes	Yes	Yes
Cap	907	908	899	990
Service Time	1.971	1.967	2.007	1.638
HCM Lane V/C Ratio	0.012	0.069	0.057	0.008
HCM Control Delay	7	7.3	7.2	6.7
HCM Lane LOS	A	A	A	A
HCM 95th-tile Q	0	0.2	0.2	0

Intersection

Intersection Delay, s/veh
 Intersection LOS

Movement	SBU	SBL	SBT	SBR
Lane Configurations			↕	
Traffic Vol, veh/h	0	0	1	6
Future Vol, veh/h	0	0	1	6
Peak Hour Factor	0.92	0.83	0.83	0.83
Heavy Vehicles, %	2	0	0	0
Mvmt Flow	0	0	1	7
Number of Lanes	0	0	1	0

Approach SB

Opposing Approach	NB
Opposing Lanes	1
Conflicting Approach Left	WB
Conflicting Lanes Left	1
Conflicting Approach Right	EB
Conflicting Lanes Right	1
HCM Control Delay	6.7
HCM LOS	A

Intersection

Int Delay, s/veh 0.2

Movement	EBL	EBR	NBL	NBT	SBT	SBR
Lane Configurations	Y			Y	Y	
Traffic Vol, veh/h	3	8	4	739	950	5
Future Vol, veh/h	3	8	4	739	950	5
Conflicting Peds, #/hr	0	0	1	0	0	1
Sign Control	Stop	Stop	Free	Free	Free	Free
RT Channelized	-	None	-	None	-	None
Storage Length	0	-	-	-	-	-
Veh in Median Storage, #	0	-	-	0	0	-
Grade, %	0	-	-	0	0	-
Peak Hour Factor	95	95	95	95	95	95
Heavy Vehicles, %	2	2	2	2	2	2
Mvmt Flow	3	8	4	778	1000	5

Major/Minor	Minor2	Major1		Major2	
Conflicting Flow All	1790	1004	1006	0	0
Stage 1	1004	-	-	-	-
Stage 2	786	-	-	-	-
Critical Hdwy	7.12	6.22	4.12	-	-
Critical Hdwy Stg 1	6.12	-	-	-	-
Critical Hdwy Stg 2	6.12	-	-	-	-
Follow-up Hdwy	3.518	3.318	2.218	-	-
Pot Cap-1 Maneuver	63	294	689	-	-
Stage 1	291	-	-	-	-
Stage 2	385	-	-	-	-
Platoon blocked, %				-	-
Mov Cap-1 Maneuver	62	294	689	-	-
Mov Cap-2 Maneuver	62	-	-	-	-
Stage 1	288	-	-	-	-
Stage 2	381	-	-	-	-

Approach	EB	NB	SB
HCM Control Delay, s	31.8	0.1	0
HCM LOS	D		

Minor Lane/Major Mvmt	NBL	NBT	EBLn1	SBT	SBR
Capacity (veh/h)	689	-	146	-	-
HCM Lane V/C Ratio	0.006	-	0.079	-	-
HCM Control Delay (s)	10.3	0	31.8	-	-
HCM Lane LOS	B	A	D	-	-
HCM 95th %tile Q(veh)	0	-	0.3	-	-

APPENDIX 6. FUTURE WITH PROJECT OPERATIONS RESULTS

Intersection

Int Delay, s/veh 0.4

Movement	WBL	WBR	NBT	NBR	SBL	SBT
Lane Configurations	↘		↑	↗		↖
Traffic Vol, veh/h	14	7	711	15	1	588
Future Vol, veh/h	14	7	711	15	1	588
Conflicting Peds, #/hr	0	0	0	0	0	0
Sign Control	Stop	Stop	Free	Free	Free	Free
RT Channelized	-	None	-	None	-	None
Storage Length	0	-	-	125	-	-
Veh in Median Storage, #	0	-	0	-	-	0
Grade, %	0	-	0	-	-	0
Peak Hour Factor	92	92	92	92	92	92
Heavy Vehicles, %	0	0	6	0	0	4
Mvmt Flow	15	8	773	16	1	639

Major/Minor	Minor1		Major1		Major2	
Conflicting Flow All	1414	773	0	0	773	0
Stage 1	773	-	-	-	-	-
Stage 2	641	-	-	-	-	-
Critical Hdwy	6.4	6.2	-	-	4.1	-
Critical Hdwy Stg 1	5.4	-	-	-	-	-
Critical Hdwy Stg 2	5.4	-	-	-	-	-
Follow-up Hdwy	3.5	3.3	-	-	2.2	-
Pot Cap-1 Maneuver	153	402	-	-	851	-
Stage 1	459	-	-	-	-	-
Stage 2	528	-	-	-	-	-
Platoon blocked, %			-	-		
Mov Cap-1 Maneuver	153	402	-	-	851	-
Mov Cap-2 Maneuver	153	-	-	-	-	-
Stage 1	459	-	-	-	-	-
Stage 2	527	-	-	-	-	-

Approach	WB		NB		SB
HCM Control Delay, s	26.1		0		0
HCM LOS	D				

Minor Lane/Major Mvmt	NBT	NBRWBLn1	SBL	SBT
Capacity (veh/h)	-	- 193	851	-
HCM Lane V/C Ratio	-	- 0.118	0.001	-
HCM Control Delay (s)	-	- 26.1	9.2	0
HCM Lane LOS	-	- D	A	A
HCM 95th %tile Q(veh)	-	- 0.4	0	-

Intersection

Int Delay, s/veh 0.1

Movement	EBL	EBT	EBR	WBL	WBT	WBR	NBL	NBT	NBR	SBL	SBT	SBR
Lane Configurations		↔			↔		↖	↗		↖	↗	
Traffic Vol, veh/h	4	0	1	0	0	0	0	716	0	0	614	4
Future Vol, veh/h	4	0	1	0	0	0	0	716	0	0	614	4
Conflicting Peds, #/hr	1	0	0	0	0	1	1	0	1	1	0	1
Sign Control	Stop	Stop	Stop	Stop	Stop	Stop	Free	Free	Free	Free	Free	Free
RT Channelized	-	-	None	-	-	None	-	-	None	-	-	None
Storage Length	-	-	-	-	-	-	65	-	-	50	-	-
Veh in Median Storage, #	-	0	-	-	0	-	-	0	-	-	0	-
Grade, %	-	0	-	-	0	-	-	0	-	-	0	-
Peak Hour Factor	93	93	93	93	93	93	93	93	93	93	93	93
Heavy Vehicles, %	0	0	0	0	0	0	0	6	0	0	4	0
Mvmt Flow	4	0	1	0	0	0	0	770	0	0	660	4

Major/Minor	Minor2			Minor1			Major1			Major2		
Conflicting Flow All	1434	1434	663	1434	1437	772	666	0	0	771	0	0
Stage 1	663	663	-	771	771	-	-	-	-	-	-	-
Stage 2	771	771	-	663	666	-	-	-	-	-	-	-
Critical Hdwy	7.1	6.5	6.2	7.1	6.5	6.2	4.1	-	-	4.1	-	-
Critical Hdwy Stg 1	6.1	5.5	-	6.1	5.5	-	-	-	-	-	-	-
Critical Hdwy Stg 2	6.1	5.5	-	6.1	5.5	-	-	-	-	-	-	-
Follow-up Hdwy	3.5	4	3.3	3.5	4	3.3	2.2	-	-	2.2	-	-
Pot Cap-1 Maneuver	113	135	465	113	135	403	933	-	-	853	-	-
Stage 1	454	462	-	396	413	-	-	-	-	-	-	-
Stage 2	396	413	-	454	460	-	-	-	-	-	-	-
Platoon blocked, %												
Mov Cap-1 Maneuver	113	135	465	113	135	402	933	-	-	852	-	-
Mov Cap-2 Maneuver	113	135	-	113	135	-	-	-	-	-	-	-
Stage 1	454	462	-	396	413	-	-	-	-	-	-	-
Stage 2	396	413	-	453	460	-	-	-	-	-	-	-

Approach	EB	WB	NB	SB
HCM Control Delay, s	33.2	0	0	0
HCM LOS	D	A		

Minor Lane/Major Mvmt	NBL	NBT	NBR	EBLn1WBLn1	SBL	SBT	SBR
Capacity (veh/h)	933	-	-	133	-	852	-
HCM Lane V/C Ratio	-	-	-	0.04	-	-	-
HCM Control Delay (s)	0	-	-	33.2	0	0	-
HCM Lane LOS	A	-	-	D	A	A	-
HCM 95th %tile Q(veh)	0	-	-	0.1	-	0	-

Intersection

Int Delay, s/veh 0.8

Movement	WBL	WBR	NBT	NBR	SBL	SBT
Lane Configurations	↘↙		↘		↘	↗
Traffic Vol, veh/h	14	38	675	4	9	599
Future Vol, veh/h	14	38	675	4	9	599
Conflicting Peds, #/hr	0	0	0	0	0	0
Sign Control	Stop	Stop	Free	Free	Free	Free
RT Channelized	-	None	-	None	-	None
Storage Length	0	-	-	-	65	-
Veh in Median Storage, #	0	-	0	-	-	0
Grade, %	0	-	0	-	-	0
Peak Hour Factor	92	92	92	92	92	92
Heavy Vehicles, %	0	0	6	0	0	4
Mvmt Flow	15	41	734	4	10	651

Major/Minor	Minor1		Major1		Major2	
Conflicting Flow All	1407	736	0	0	738	0
Stage 1	736	-	-	-	-	-
Stage 2	671	-	-	-	-	-
Critical Hdwy	6.4	6.2	-	-	4.1	-
Critical Hdwy Stg 1	5.4	-	-	-	-	-
Critical Hdwy Stg 2	5.4	-	-	-	-	-
Follow-up Hdwy	3.5	3.3	-	-	2.2	-
Pot Cap-1 Maneuver	155	422	-	-	877	-
Stage 1	477	-	-	-	-	-
Stage 2	512	-	-	-	-	-
Platoon blocked, %			-	-		-
Mov Cap-1 Maneuver	153	422	-	-	877	-
Mov Cap-2 Maneuver	153	-	-	-	-	-
Stage 1	477	-	-	-	-	-
Stage 2	506	-	-	-	-	-

Approach	WB		NB		SB
HCM Control Delay, s	20.7		0		0.1
HCM LOS	C				

Minor Lane/Major Mvmt	NBT	NBRWBLn1	SBL	SBT
Capacity (veh/h)	-	- 286	877	-
HCM Lane V/C Ratio	-	- 0.198	0.011	-
HCM Control Delay (s)	-	- 20.7	9.2	-
HCM Lane LOS	-	- C	A	-
HCM 95th %tile Q(veh)	-	- 0.7	0	-

Intersection

Int Delay, s/veh 7.6

Movement	WBL	WBR	NBT	NBR	SBL	SBT
Lane Configurations	Y		P			A
Traffic Vol, veh/h	1	22	1	0	5	1
Future Vol, veh/h	1	22	1	0	5	1
Conflicting Peds, #/hr	0	0	0	0	0	0
Sign Control	Stop	Stop	Free	Free	Free	Free
RT Channelized	-	None	-	None	-	None
Storage Length	0	-	-	-	-	-
Veh in Median Storage, #	0	-	0	-	-	0
Grade, %	0	-	0	-	-	0
Peak Hour Factor	75	75	75	75	75	75
Heavy Vehicles, %	0	0	0	0	0	0
Mvmt Flow	1	29	1	0	7	1

Major/Minor	Minor1		Major1		Major2	
Conflicting Flow All	16	1	0	0	1	0
Stage 1	1	-	-	-	-	-
Stage 2	15	-	-	-	-	-
Critical Hdwy	6.4	6.2	-	-	4.1	-
Critical Hdwy Stg 1	5.4	-	-	-	-	-
Critical Hdwy Stg 2	5.4	-	-	-	-	-
Follow-up Hdwy	3.5	3.3	-	-	2.2	-
Pot Cap-1 Maneuver	1008	1090	-	-	1635	-
Stage 1	1028	-	-	-	-	-
Stage 2	1013	-	-	-	-	-
Platoon blocked, %			-	-		-
Mov Cap-1 Maneuver	1004	1090	-	-	1635	-
Mov Cap-2 Maneuver	1004	-	-	-	-	-
Stage 1	1028	-	-	-	-	-
Stage 2	1009	-	-	-	-	-

Approach	WB		NB		SB
HCM Control Delay, s	8.4		0		6
HCM LOS	A				

Minor Lane/Major Mvmt	NBT	NBRWBLn1	SBL	SBT
Capacity (veh/h)	-	- 1086	1635	-
HCM Lane V/C Ratio	-	- 0.028	0.004	-
HCM Control Delay (s)	-	- 8.4	7.2	0
HCM Lane LOS	-	- A	A	A
HCM 95th %tile Q(veh)	-	- 0.1	0	-

Intersection

Int Delay, s/veh 5.7

Movement	EBT	EBR	WBL	WBT	NBL	NBR
Lane Configurations	↔		↔		↔	
Traffic Vol, veh/h	2	3	0	4	18	0
Future Vol, veh/h	2	3	0	4	18	0
Conflicting Peds, #/hr	0	0	0	0	0	1
Sign Control	Free	Free	Free	Free	Stop	Stop
RT Channelized	-	None	-	None	-	None
Storage Length	-	-	-	-	0	-
Veh in Median Storage, #	0	-	-	0	0	-
Grade, %	0	-	-	0	0	-
Peak Hour Factor	70	70	70	70	70	70
Heavy Vehicles, %	0	0	0	0	0	0
Mvmt Flow	3	4	0	6	26	0

Major/Minor	Major1		Major2		Minor1	
Conflicting Flow All	0	0	7	0	11	6
Stage 1	-	-	-	-	5	-
Stage 2	-	-	-	-	6	-
Critical Hdwy	-	-	4.1	-	6.4	6.2
Critical Hdwy Stg 1	-	-	-	-	5.4	-
Critical Hdwy Stg 2	-	-	-	-	5.4	-
Follow-up Hdwy	-	-	2.2	-	3.5	3.3
Pot Cap-1 Maneuver	-	-	1627	-	1014	1083
Stage 1	-	-	-	-	1023	-
Stage 2	-	-	-	-	1022	-
Platoon blocked, %	-	-	-	-	-	-
Mov Cap-1 Maneuver	-	-	1625	-	1014	1082
Mov Cap-2 Maneuver	-	-	-	-	1014	-
Stage 1	-	-	-	-	1023	-
Stage 2	-	-	-	-	1022	-

Approach	EB	WB	NB
HCM Control Delay, s	0	0	8.6
HCM LOS			A

Minor Lane/Major Mvmt	NBLn1	EBT	EBR	WBL	WBT
Capacity (veh/h)	1014	-	-	1625	-
HCM Lane V/C Ratio	0.025	-	-	-	-
HCM Control Delay (s)	8.6	-	-	0	-
HCM Lane LOS	A	-	-	A	-
HCM 95th %tile Q(veh)	0.1	-	-	0	-

Intersection

Int Delay, s/veh 0.6

Movement	EBL	EBT	EBR	WBL	WBT	WBR	NBL	NBT	NBR	SBL	SBT	SBR
Lane Configurations		↔			↔		↖	↗		↖	↗	
Traffic Vol, veh/h	3	0	5	2	0	26	4	652	4	10	596	0
Future Vol, veh/h	3	0	5	2	0	26	4	652	4	10	596	0
Conflicting Peds, #/hr	0	0	0	0	0	0	1	0	0	0	0	1
Sign Control	Stop	Stop	Stop	Stop	Stop	Stop	Free	Free	Free	Free	Free	Free
RT Channelized	-	-	None	-	-	None	-	-	None	-	-	None
Storage Length	-	-	-	-	-	-	125	-	-	125	-	-
Veh in Median Storage, #	-	0	-	-	0	-	-	0	-	-	0	-
Grade, %	-	0	-	-	0	-	-	0	-	-	0	-
Peak Hour Factor	90	90	90	90	90	90	90	90	90	90	90	90
Heavy Vehicles, %	0	0	0	0	0	4	0	6	0	0	4	0
Mvmt Flow	3	0	6	2	0	29	4	724	4	11	662	0

Major/Minor	Minor2			Minor1			Major1			Major2		
Conflicting Flow All	1435	1423	663	1423	1421	727	663	0	0	729	0	0
Stage 1	685	685	-	736	736	-	-	-	-	-	-	-
Stage 2	750	738	-	687	685	-	-	-	-	-	-	-
Critical Hdwy	7.1	6.5	6.2	7.1	6.5	6.24	4.1	-	-	4.1	-	-
Critical Hdwy Stg 1	6.1	5.5	-	6.1	5.5	-	-	-	-	-	-	-
Critical Hdwy Stg 2	6.1	5.5	-	6.1	5.5	-	-	-	-	-	-	-
Follow-up Hdwy	3.5	4	3.3	3.5	4	3.336	2.2	-	-	2.2	-	-
Pot Cap-1 Maneuver	113	137	465	115	138	421	935	-	-	884	-	-
Stage 1	441	451	-	414	428	-	-	-	-	-	-	-
Stage 2	407	427	-	440	451	-	-	-	-	-	-	-
Platoon blocked, %												
Mov Cap-1 Maneuver	104	135	465	112	136	421	935	-	-	884	-	-
Mov Cap-2 Maneuver	104	135	-	112	136	-	-	-	-	-	-	-
Stage 1	439	445	-	412	426	-	-	-	-	-	-	-
Stage 2	377	425	-	429	445	-	-	-	-	-	-	-

Approach	EB	WB	NB	SB
HCM Control Delay, s	23.6	16.2	0.1	0.2
HCM LOS	C	C		

Minor Lane/Major Mvmt	NBL	NBT	NBR	EBLn1WBLn1	SBL	SBT	SBR
Capacity (veh/h)	935	-	-	202	352	884	-
HCM Lane V/C Ratio	0.005	-	-	0.044	0.088	0.013	-
HCM Control Delay (s)	8.9	-	-	23.6	16.2	9.1	-
HCM Lane LOS	A	-	-	C	C	A	-
HCM 95th %tile Q(veh)	0	-	-	0.1	0.3	0	-

Intersection

Int Delay, s/veh 2.8

Movement	EBL	EBT	EBR	WBL	WBT	WBR	NBL	NBT	NBR	SBL	SBT	SBR
Lane Configurations		↔			↔		↔	↔		↔	↔	
Traffic Vol, veh/h	10	0	11	48	0	15	4	640	21	6	592	6
Future Vol, veh/h	10	0	11	48	0	15	4	640	21	6	592	6
Conflicting Peds, #/hr	0	0	0	0	0	0	1	0	0	0	0	1
Sign Control	Stop	Stop	Stop	Stop	Stop	Stop	Free	Free	Free	Free	Free	Free
RT Channelized	-	-	None	-	-	None	-	-	None	-	-	None
Storage Length	-	-	-	-	-	-	80	-	-	125	-	-
Veh in Median Storage, #	-	0	-	-	0	-	-	0	-	-	0	-
Grade, %	-	0	-	-	0	-	-	0	-	-	0	-
Peak Hour Factor	93	93	93	93	93	93	93	93	93	93	93	93
Heavy Vehicles, %	2	2	2	2	2	2	2	2	2	2	2	2
Mvmt Flow	11	0	12	52	0	16	4	688	23	6	637	6

Major/Minor	Minor2			Minor1			Major1			Major2		
Conflicting Flow All	1370	1373	641	1367	1365	699	644	0	0	711	0	0
Stage 1	654	654	-	708	708	-	-	-	-	-	-	-
Stage 2	716	719	-	659	657	-	-	-	-	-	-	-
Critical Hdwy	7.12	6.52	6.22	7.12	6.52	6.22	4.12	-	-	4.12	-	-
Critical Hdwy Stg 1	6.12	5.52	-	6.12	5.52	-	-	-	-	-	-	-
Critical Hdwy Stg 2	6.12	5.52	-	6.12	5.52	-	-	-	-	-	-	-
Follow-up Hdwy	3.518	4.018	3.318	3.518	4.018	3.318	2.218	-	-	2.218	-	-
Pot Cap-1 Maneuver	124	146	475	124	147	440	941	-	-	888	-	-
Stage 1	456	463	-	426	438	-	-	-	-	-	-	-
Stage 2	421	433	-	453	462	-	-	-	-	-	-	-
Platoon blocked, %												
Mov Cap-1 Maneuver	118	144	475	120	145	440	941	-	-	888	-	-
Mov Cap-2 Maneuver	118	144	-	120	145	-	-	-	-	-	-	-
Stage 1	454	459	-	424	436	-	-	-	-	-	-	-
Stage 2	404	431	-	439	458	-	-	-	-	-	-	-

Approach	EB	WB	NB	SB
HCM Control Delay, s	25.9	49.9	0.1	0.1
HCM LOS	D	E		

Minor Lane/Major Mvmt	NBL	NBT	NBR	EBLn1WBLn1	SBL	SBT	SBR
Capacity (veh/h)	941	-	-	195	145	888	-
HCM Lane V/C Ratio	0.005	-	-	0.116	0.467	0.007	-
HCM Control Delay (s)	8.8	-	-	25.9	49.9	9.1	-
HCM Lane LOS	A	-	-	D	E	A	-
HCM 95th %tile Q(veh)	0	-	-	0.4	2.2	0	-

Intersection

Int Delay, s/veh 1.6

Movement	EBL	EBT	EBR	WBL	WBT	WBR	NBL	NBT	NBR	SBL	SBT	SBR
Lane Configurations		↕			↕			↕			↕	
Traffic Vol, veh/h	6	16	0	1	65	0	3	2	0	2	2	3
Future Vol, veh/h	6	16	0	1	65	0	3	2	0	2	2	3
Conflicting Peds, #/hr	1	0	0	0	0	1	0	0	1	1	0	0
Sign Control	Free	Free	Free	Free	Free	Free	Stop	Stop	Stop	Stop	Stop	Stop
RT Channelized	-	-	None	-	-	None	-	-	None	-	-	None
Storage Length	-	-	-	-	-	-	-	-	-	-	-	-
Veh in Median Storage, #	-	0	-	-	0	-	-	0	-	-	0	-
Grade, %	-	0	-	-	0	-	-	0	-	-	0	-
Peak Hour Factor	74	74	74	74	74	74	74	74	74	74	74	74
Heavy Vehicles, %	0	0	0	0	0	0	33	0	0	0	0	0
Mvmt Flow	8	22	0	1	88	0	4	3	0	3	3	4

Major/Minor	Major1			Major2			Minor1			Minor2		
Conflicting Flow All	89	0	0	22	0	0	132	130	23	132	130	89
Stage 1	-	-	-	-	-	-	38	38	-	92	92	-
Stage 2	-	-	-	-	-	-	94	92	-	40	38	-
Critical Hdwy	4.1	-	-	4.1	-	-	7.43	6.5	6.2	7.1	6.5	6.2
Critical Hdwy Stg 1	-	-	-	-	-	-	6.43	5.5	-	6.1	5.5	-
Critical Hdwy Stg 2	-	-	-	-	-	-	6.43	5.5	-	6.1	5.5	-
Follow-up Hdwy	2.2	-	-	2.2	-	-	3.797	4	3.3	3.5	4	3.3
Pot Cap-1 Maneuver	1519	-	-	1607	-	-	773	764	1060	845	764	975
Stage 1	-	-	-	-	-	-	904	867	-	920	823	-
Stage 2	-	-	-	-	-	-	842	823	-	980	867	-
Platoon blocked, %		-	-		-	-						
Mov Cap-1 Maneuver	1519	-	-	1605	-	-	764	759	1059	837	759	974
Mov Cap-2 Maneuver	-	-	-	-	-	-	764	759	-	837	759	-
Stage 1	-	-	-	-	-	-	899	863	-	915	821	-
Stage 2	-	-	-	-	-	-	835	821	-	971	863	-

Approach	EB	WB	NB	SB
HCM Control Delay, s	2	0.1	9.8	9.2
HCM LOS			A	A

Minor Lane/Major Mvmt	NBLn1	EBL	EBT	EBR	WBL	WBT	WBR	SBLn1
Capacity (veh/h)	762	1519	-	-	1605	-	-	864
HCM Lane V/C Ratio	0.009	0.005	-	-	0.001	-	-	0.011
HCM Control Delay (s)	9.8	7.4	0	-	7.2	0	-	9.2
HCM Lane LOS	A	A	A	-	A	A	-	A
HCM 95th %tile Q(veh)	0	0	-	-	0	-	-	0

Intersection

Int Delay, s/veh 7.7

Movement	EBL	EBT	EBR	WBL	WBT	WBR	NBL	NBT	NBR	SBL	SBT	SBR
Lane Configurations		↕			↕			↕			↕	
Traffic Vol, veh/h	0	14	0	1	65	9	2	17	0	1	4	0
Future Vol, veh/h	0	14	0	1	65	9	2	17	0	1	4	0
Conflicting Peds, #/hr	1	0	0	0	0	1	0	0	0	0	0	0
Sign Control	Stop	Stop	Stop	Stop	Stop	Stop	Free	Free	Free	Free	Free	Free
RT Channelized	-	-	None	-	-	None	-	-	None	-	-	None
Storage Length	-	-	-	-	-	-	-	-	-	-	-	-
Veh in Median Storage, #	-	0	-	-	0	-	-	0	-	-	0	-
Grade, %	-	0	-	-	0	-	-	0	-	-	0	-
Peak Hour Factor	83	83	83	83	83	83	83	83	83	83	83	83
Heavy Vehicles, %	0	0	0	0	0	0	0	6	0	0	0	0
Mvmt Flow	0	17	0	1	78	11	2	20	0	1	5	0

Major/Minor	Minor2			Minor1			Major1			Major2		
Conflicting Flow All	78	32	5	41	32	21	5	0	0	20	0	0
Stage 1	7	7	-	25	25	-	-	-	-	-	-	-
Stage 2	71	25	-	16	7	-	-	-	-	-	-	-
Critical Hdwy	7.1	6.5	6.2	7.1	6.5	6.2	4.1	-	-	4.1	-	-
Critical Hdwy Stg 1	6.1	5.5	-	6.1	5.5	-	-	-	-	-	-	-
Critical Hdwy Stg 2	6.1	5.5	-	6.1	5.5	-	-	-	-	-	-	-
Follow-up Hdwy	3.5	4	3.3	3.5	4	3.3	2.2	-	-	2.2	-	-
Pot Cap-1 Maneuver	916	865	1084	968	865	1062	1630	-	-	1609	-	-
Stage 1	1020	894	-	998	878	-	-	-	-	-	-	-
Stage 2	944	878	-	1009	894	-	-	-	-	-	-	-
Platoon blocked, %												
Mov Cap-1 Maneuver	842	863	1084	952	863	1061	1630	-	-	1607	-	-
Mov Cap-2 Maneuver	842	863	-	952	863	-	-	-	-	-	-	-
Stage 1	1019	893	-	997	877	-	-	-	-	-	-	-
Stage 2	849	877	-	989	893	-	-	-	-	-	-	-

Approach	EB	WB	NB	SB
HCM Control Delay, s	9.3	9.5	0.8	1.4
HCM LOS	A	A		

Minor Lane/Major Mvmt	NBL	NBT	NBR	EBLn1WBLn1	SBL	SBT	SBR
Capacity (veh/h)	1630	-	-	863 884	1607	-	-
HCM Lane V/C Ratio	0.001	-	-	0.02 0.102	0.001	-	-
HCM Control Delay (s)	7.2	0	-	9.3 9.5	7.2	0	-
HCM Lane LOS	A	A	-	A A	A	A	-
HCM 95th %tile Q(veh)	0	-	-	0.1 0.3	0	-	-

Intersection	
Intersection Delay, s/veh	7.2
Intersection LOS	A

Movement	EBU	EBL	EBT	EBR	WBU	WBL	WBT	WBR	NBU	NBL	NBT	NBR
Lane Configurations			↕				↕				↕	
Traffic Vol, veh/h	0	0	17	1	0	5	63	1	0	1	1	2
Future Vol, veh/h	0	0	17	1	0	5	63	1	0	1	1	2
Peak Hour Factor	0.92	0.90	0.90	0.90	0.92	0.90	0.90	0.90	0.92	0.90	0.90	0.90
Heavy Vehicles, %	2	0	6	0	2	0	0	0	2	0	0	0
Mvmt Flow	0	0	19	1	0	6	70	1	0	1	1	2
Number of Lanes	0	0	1	0	0	0	1	0	0	0	1	0

Approach	EB	WB	NB
Opposing Approach	WB	EB	SB
Opposing Lanes	1	1	1
Conflicting Approach Left	SB	NB	EB
Conflicting Lanes Left	1	1	1
Conflicting Approach Right	NB	SB	WB
Conflicting Lanes Right	1	1	1
HCM Control Delay	7.2	7.3	6.9
HCM LOS	A	A	A

Lane	NBLn1	EBLn1	WBLn1	SBLn1
Vol Left, %	25%	0%	7%	0%
Vol Thru, %	25%	94%	91%	0%
Vol Right, %	50%	6%	1%	100%
Sign Control	Stop	Stop	Stop	Stop
Traffic Vol by Lane	4	18	69	6
LT Vol	1	0	5	0
Through Vol	1	17	63	0
RT Vol	2	1	1	6
Lane Flow Rate	4	20	77	7
Geometry Grp	1	1	1	1
Degree of Util (X)	0.005	0.022	0.084	0.006
Departure Headway (Hd)	3.823	4.045	3.94	3.47
Convergence, Y/N	Yes	Yes	Yes	Yes
Cap	932	887	913	1026
Service Time	1.861	2.061	1.946	1.51
HCM Lane V/C Ratio	0.004	0.023	0.084	0.007
HCM Control Delay	6.9	7.2	7.3	6.5
HCM Lane LOS	A	A	A	A
HCM 95th-tile Q	0	0.1	0.3	0

Intersection

Intersection Delay, s/veh

Intersection LOS

Movement	SBU	SBL	SBT	SBR
Lane Configurations			↔	
Traffic Vol, veh/h	0	0	0	6
Future Vol, veh/h	0	0	0	6
Peak Hour Factor	0.92	0.90	0.90	0.90
Heavy Vehicles, %	2	0	0	0
Mvmt Flow	0	0	0	7
Number of Lanes	0	0	1	0

Approach SB

Opposing Approach	NB
Opposing Lanes	1
Conflicting Approach Left	WB
Conflicting Lanes Left	1
Conflicting Approach Right	EB
Conflicting Lanes Right	1
HCM Control Delay	6.5
HCM LOS	A

Intersection

Int Delay, s/veh 0.2

Movement	EBL	EBR	NBL	NBT	SBT	SBR
Lane Configurations	Y			Y	Y	
Traffic Vol, veh/h	3	6	7	659	598	0
Future Vol, veh/h	3	6	7	659	598	0
Conflicting Peds, #/hr	0	0	1	0	0	1
Sign Control	Stop	Stop	Free	Free	Free	Free
RT Channelized	-	None	-	None	-	None
Storage Length	0	-	-	-	-	-
Veh in Median Storage, #	0	-	-	0	0	-
Grade, %	0	-	-	0	0	-
Peak Hour Factor	93	93	93	93	93	93
Heavy Vehicles, %	2	2	2	2	2	2
Mvmt Flow	3	6	8	709	643	0

Major/Minor	Minor2	Major1	Major2
Conflicting Flow All	1368	644	0
Stage 1	644	-	-
Stage 2	724	-	-
Critical Hdwy	6.42	6.22	4.12
Critical Hdwy Stg 1	5.42	-	-
Critical Hdwy Stg 2	5.42	-	-
Follow-up Hdwy	3.518	3.318	2.218
Pot Cap-1 Maneuver	162	473	941
Stage 1	523	-	-
Stage 2	480	-	-
Platoon blocked, %			-
Mov Cap-1 Maneuver	159	473	941
Mov Cap-2 Maneuver	159	-	-
Stage 1	523	-	-
Stage 2	473	-	-

Approach	EB	NB	SB
HCM Control Delay, s	18.1	0.1	0
HCM LOS	C		

Minor Lane/Major Mvmt	NBL	NBT	EBLn1	SBT	SBR
Capacity (veh/h)	941	-	285	-	-
HCM Lane V/C Ratio	0.008	-	0.034	-	-
HCM Control Delay (s)	8.9	0	18.1	-	-
HCM Lane LOS	A	A	C	-	-
HCM 95th %tile Q(veh)	0	-	0.1	-	-

Intersection

Int Delay, s/veh 0.4

Movement	WBL	WBR	NBT	NBR	SBL	SBT
Lane Configurations	↘↗		↑	↗		↖
Traffic Vol, veh/h	11	5	739	18	5	939
Future Vol, veh/h	11	5	739	18	5	939
Conflicting Peds, #/hr	0	0	0	1	1	0
Sign Control	Stop	Stop	Free	Free	Free	Free
RT Channelized	-	None	-	None	-	None
Storage Length	0	-	-	125	-	-
Veh in Median Storage, #	0	-	0	-	-	0
Grade, %	0	-	0	-	-	0
Peak Hour Factor	95	95	95	95	95	95
Heavy Vehicles, %	0	0	2	0	0	2
Mvmt Flow	12	5	778	19	5	988

Major/Minor	Minor1		Major1		Major2	
Conflicting Flow All	1778	779	0	0	779	0
Stage 1	779	-	-	-	-	-
Stage 2	999	-	-	-	-	-
Critical Hdwy	6.4	6.2	-	-	4.1	-
Critical Hdwy Stg 1	5.4	-	-	-	-	-
Critical Hdwy Stg 2	5.4	-	-	-	-	-
Follow-up Hdwy	3.5	3.3	-	-	2.2	-
Pot Cap-1 Maneuver	92	399	-	-	847	-
Stage 1	456	-	-	-	-	-
Stage 2	359	-	-	-	-	-
Platoon blocked, %			-	-		
Mov Cap-1 Maneuver	91	399	-	-	847	-
Mov Cap-2 Maneuver	91	-	-	-	-	-
Stage 1	456	-	-	-	-	-
Stage 2	354	-	-	-	-	-

Approach	WB		NB		SB
HCM Control Delay, s	39.8		0		0
HCM LOS	E				

Minor Lane/Major Mvmt	NBT	NBRWBLn1	SBL	SBT
Capacity (veh/h)	-	-	120	847
HCM Lane V/C Ratio	-	-	0.14	0.006
HCM Control Delay (s)	-	-	39.8	9.3
HCM Lane LOS	-	-	E	A
HCM 95th %tile Q(veh)	-	-	0.5	0

Intersection

Int Delay, s/veh 0.3

Movement	EBL	EBT	EBR	WBL	WBT	WBR	NBL	NBT	NBR	SBL	SBT	SBR
Lane Configurations		↔			↔		↑	↑		↑	↑	
Traffic Vol, veh/h	5	0	4	1	0	2	0	751	0	1	935	4
Future Vol, veh/h	5	0	4	1	0	2	0	751	0	1	935	4
Conflicting Peds, #/hr	5	0	0	0	0	5	0	0	4	4	0	0
Sign Control	Stop	Stop	Stop	Stop	Stop	Stop	Free	Free	Free	Free	Free	Free
RT Channelized	-	-	None	-	-	None	-	-	None	-	-	None
Storage Length	-	-	-	-	-	-	65	-	-	50	-	-
Veh in Median Storage, #	-	0	-	-	0	-	-	0	-	-	0	-
Grade, %	-	0	-	-	0	-	-	0	-	-	0	-
Peak Hour Factor	94	94	94	94	94	94	94	94	94	94	94	94
Heavy Vehicles, %	0	0	0	0	0	0	0	2	0	0	1	0
Mvmt Flow	5	0	4	1	0	2	0	799	0	1	995	4

Major/Minor	Minor2			Minor1			Major1			Major2		
Conflicting Flow All	1804	1802	997	1804	1804	808	999	0	0	803	0	0
Stage 1	999	999	-	803	803	-	-	-	-	-	-	-
Stage 2	805	803	-	1001	1001	-	-	-	-	-	-	-
Critical Hdwy	7.1	6.5	6.2	7.1	6.5	6.2	4.1	-	-	4.1	-	-
Critical Hdwy Stg 1	6.1	5.5	-	6.1	5.5	-	-	-	-	-	-	-
Critical Hdwy Stg 2	6.1	5.5	-	6.1	5.5	-	-	-	-	-	-	-
Follow-up Hdwy	3.5	4	3.3	3.5	4	3.3	2.2	-	-	2.2	-	-
Pot Cap-1 Maneuver	62	80	299	62	80	384	701	-	-	830	-	-
Stage 1	296	324	-	380	399	-	-	-	-	-	-	-
Stage 2	379	399	-	295	323	-	-	-	-	-	-	-
Platoon blocked, %												
Mov Cap-1 Maneuver	61	80	299	61	80	381	701	-	-	826	-	-
Mov Cap-2 Maneuver	61	80	-	61	80	-	-	-	-	-	-	-
Stage 1	296	324	-	379	397	-	-	-	-	-	-	-
Stage 2	375	397	-	290	323	-	-	-	-	-	-	-

Approach	EB	WB	NB	SB
HCM Control Delay, s	47.6	31.5	0	0
HCM LOS	E	D		

Minor Lane/Major Mvmt	NBL	NBT	NBR	EBLn1WBLn1	SBL	SBT	SBR
Capacity (veh/h)	701	-	-	94	139	826	-
HCM Lane V/C Ratio	-	-	-	0.102	0.023	0.001	-
HCM Control Delay (s)	0	-	-	47.6	31.5	9.4	-
HCM Lane LOS	A	-	-	E	D	A	-
HCM 95th %tile Q(veh)	0	-	-	0.3	0.1	0	-

Intersection

Int Delay, s/veh 0.6

Movement	WBL	WBR	NBT	NBR	SBL	SBT
Lane Configurations	↘		↗		↘	↗
Traffic Vol, veh/h	9	12	739	13	34	912
Future Vol, veh/h	9	12	739	13	34	912
Conflicting Peds, #/hr	0	0	0	2	2	0
Sign Control	Stop	Stop	Free	Free	Free	Free
RT Channelized	-	None	-	None	-	None
Storage Length	0	-	-	-	65	-
Veh in Median Storage, #	0	-	0	-	-	0
Grade, %	0	-	0	-	-	0
Peak Hour Factor	96	96	96	96	96	96
Heavy Vehicles, %	0	0	2	0	0	2
Mvmt Flow	9	13	770	14	35	950

Major/Minor	Minor1		Major1		Major2	
Conflicting Flow All	1800	779	0	0	785	0
Stage 1	779	-	-	-	-	-
Stage 2	1021	-	-	-	-	-
Critical Hdwy	6.4	6.2	-	-	4.1	-
Critical Hdwy Stg 1	5.4	-	-	-	-	-
Critical Hdwy Stg 2	5.4	-	-	-	-	-
Follow-up Hdwy	3.5	3.3	-	-	2.2	-
Pot Cap-1 Maneuver	89	399	-	-	843	-
Stage 1	456	-	-	-	-	-
Stage 2	351	-	-	-	-	-
Platoon blocked, %			-	-		
Mov Cap-1 Maneuver	85	398	-	-	843	-
Mov Cap-2 Maneuver	85	-	-	-	-	-
Stage 1	455	-	-	-	-	-
Stage 2	336	-	-	-	-	-

Approach	WB		NB		SB
HCM Control Delay, s	32.2		0		0.3
HCM LOS	D				

Minor Lane/Major Mvmt	NBT	NBRWBLn1	SBL	SBT
Capacity (veh/h)	-	- 154	843	-
HCM Lane V/C Ratio	-	- 0.142	0.042	-
HCM Control Delay (s)	-	- 32.2	9.5	-
HCM Lane LOS	-	- D	A	-
HCM 95th %tile Q(veh)	-	- 0.5	0.1	-

Intersection

Int Delay, s/veh 6.3

Movement	WBL	WBR	NBT	NBR	SBL	SBT
Lane Configurations	Y		P			A
Traffic Vol, veh/h	4	6	1	6	19	0
Future Vol, veh/h	4	6	1	6	19	0
Conflicting Peds, #/hr	1	0	0	5	5	0
Sign Control	Stop	Stop	Free	Free	Free	Free
RT Channelized	-	None	-	None	-	None
Storage Length	0	-	-	-	-	-
Veh in Median Storage, #	0	-	0	-	-	0
Grade, %	0	-	0	-	-	0
Peak Hour Factor	75	75	75	75	75	75
Heavy Vehicles, %	0	17	0	0	0	0
Mvmt Flow	5	8	1	8	25	0

Major/Minor	Minor1		Major1		Major2	
Conflicting Flow All	62	10	0	0	14	0
Stage 1	10	-	-	-	-	-
Stage 2	52	-	-	-	-	-
Critical Hdwy	6.4	6.37	-	-	4.1	-
Critical Hdwy Stg 1	5.4	-	-	-	-	-
Critical Hdwy Stg 2	5.4	-	-	-	-	-
Follow-up Hdwy	3.5	3.453	-	-	2.2	-
Pot Cap-1 Maneuver	949	1029	-	-	1617	-
Stage 1	1018	-	-	-	-	-
Stage 2	976	-	-	-	-	-
Platoon blocked, %			-	-		-
Mov Cap-1 Maneuver	929	1024	-	-	1617	-
Mov Cap-2 Maneuver	929	-	-	-	-	-
Stage 1	1013	-	-	-	-	-
Stage 2	960	-	-	-	-	-

Approach	WB		NB		SB
HCM Control Delay, s	8.7		0		7.3
HCM LOS	A				

Minor Lane/Major Mvmt	NBT	NBRWBLn1	SBL	SBT
Capacity (veh/h)	-	- 984	1617	-
HCM Lane V/C Ratio	-	- 0.014	0.016	-
HCM Control Delay (s)	-	- 8.7	7.3	0
HCM Lane LOS	-	- A	A	A
HCM 95th %tile Q(veh)	-	- 0	0	-

Intersection

Int Delay, s/veh 2

Movement	EBT	EBR	WBL	WBT	NBL	NBR
Lane Configurations	↔			↔	↔	
Traffic Vol, veh/h	8	16	1	4	7	0
Future Vol, veh/h	8	16	1	4	7	0
Conflicting Peds, #/hr	0	3	3	0	1	0
Sign Control	Free	Free	Free	Free	Stop	Stop
RT Channelized	-	None	-	None	-	None
Storage Length	-	-	-	-	0	-
Veh in Median Storage, #	0	-	-	0	0	-
Grade, %	0	-	-	0	0	-
Peak Hour Factor	69	69	69	69	69	69
Heavy Vehicles, %	0	0	0	0	29	0
Mvmt Flow	12	23	1	6	10	0

Major/Minor	Major1	Major2	Minor1
Conflicting Flow All	0	38	36
Stage 1	-	-	26
Stage 2	-	-	10
Critical Hdwy	-	4.1	7.39
Critical Hdwy Stg 1	-	-	6.39
Critical Hdwy Stg 2	-	-	6.39
Follow-up Hdwy	-	2.2	3.761
Pot Cap-1 Maneuver	-	1585	906
Stage 1	-	-	926
Stage 2	-	-	945
Platoon blocked, %	-	-	-
Mov Cap-1 Maneuver	-	1585	902
Mov Cap-2 Maneuver	-	-	902
Stage 1	-	-	926
Stage 2	-	-	943

Approach	EB	WB	NB
HCM Control Delay, s	0	1.5	9
HCM LOS			A

Minor Lane/Major Mvmt	NBLn1	EBT	EBR	WBL	WBT
Capacity (veh/h)	902	-	-	1585	-
HCM Lane V/C Ratio	0.011	-	-	0.001	-
HCM Control Delay (s)	9	-	-	7.3	0
HCM Lane LOS	A	-	-	A	A
HCM 95th %tile Q(veh)	0	-	-	0	-

Intersection

Int Delay, s/veh 1

Movement	EBL	EBT	EBR	WBL	WBT	WBR	NBL	NBT	NBR	SBL	SBT	SBR
Lane Configurations		↕			↕		↕	↕		↕	↕	
Traffic Vol, veh/h	7	0	7	7	0	17	10	729	7	28	882	5
Future Vol, veh/h	7	0	7	7	0	17	10	729	7	28	882	5
Conflicting Peds, #/hr	0	0	0	0	0	0	0	0	2	2	0	0
Sign Control	Stop	Stop	Stop	Stop	Stop	Stop	Free	Free	Free	Free	Free	Free
RT Channelized	-	-	None	-	-	None	-	-	None	-	-	None
Storage Length	-	-	-	-	-	-	125	-	-	125	-	-
Veh in Median Storage, #	-	0	-	-	0	-	-	0	-	-	0	-
Grade, %	-	0	-	-	0	-	-	0	-	-	0	-
Peak Hour Factor	96	96	96	96	96	96	96	96	96	96	96	96
Heavy Vehicles, %	0	0	0	0	0	0	0	2	14	7	2	0
Mvmt Flow	7	0	7	7	0	18	10	759	7	29	919	5

Major/Minor	Minor2			Minor1			Major1			Major2		
Conflicting Flow All	1773	1770	921	1769	1768	765	924	0	0	769	0	0
Stage 1	980	980	-	786	786	-	-	-	-	-	-	-
Stage 2	793	790	-	983	982	-	-	-	-	-	-	-
Critical Hdwy	7.1	6.5	6.2	7.1	6.5	6.2	4.1	-	-	4.17	-	-
Critical Hdwy Stg 1	6.1	5.5	-	6.1	5.5	-	-	-	-	-	-	-
Critical Hdwy Stg 2	6.1	5.5	-	6.1	5.5	-	-	-	-	-	-	-
Follow-up Hdwy	3.5	4	3.3	3.5	4	3.3	2.2	-	-	2.263	-	-
Pot Cap-1 Maneuver	65	84	331	66	84	406	748	-	-	823	-	-
Stage 1	303	331	-	388	406	-	-	-	-	-	-	-
Stage 2	385	404	-	302	330	-	-	-	-	-	-	-
Platoon blocked, %												
Mov Cap-1 Maneuver	60	80	331	62	80	405	748	-	-	823	-	-
Mov Cap-2 Maneuver	60	80	-	62	80	-	-	-	-	-	-	-
Stage 1	299	319	-	382	400	-	-	-	-	-	-	-
Stage 2	363	398	-	285	318	-	-	-	-	-	-	-

Approach	EB	WB	NB	SB
HCM Control Delay, s	46.1	32.6	0.1	0.3
HCM LOS	E	D		

Minor Lane/Major Mvmt	NBL	NBT	NBR	EBLn1WBLn1	SBL	SBT	SBR
Capacity (veh/h)	748	-	-	102	155	823	-
HCM Lane V/C Ratio	0.014	-	-	0.143	0.161	0.035	-
HCM Control Delay (s)	9.9	-	-	46.1	32.6	9.5	-
HCM Lane LOS	A	-	-	E	D	A	-
HCM 95th %tile Q(veh)	0	-	-	0.5	0.6	0.1	-

Intersection

Int Delay, s/veh 3.5

Movement	EBL	EBT	EBR	WBL	WBT	WBR	NBL	NBT	NBR	SBL	SBT	SBR
Lane Configurations		↔			↔		↔	↔		↔	↔	
Traffic Vol, veh/h	3	0	3	32	0	13	5	734	42	17	876	10
Future Vol, veh/h	3	0	3	32	0	13	5	734	42	17	876	10
Conflicting Peds, #/hr	1	0	0	0	0	1	1	0	0	0	0	1
Sign Control	Stop	Stop	Stop	Stop	Stop	Stop	Free	Free	Free	Free	Free	Free
RT Channelized	-	-	None	-	-	None	-	-	None	-	-	None
Storage Length	-	-	-	-	-	-	80	-	-	125	-	-
Veh in Median Storage, #	-	0	-	-	0	-	-	0	-	-	0	-
Grade, %	-	0	-	-	0	-	-	0	-	-	0	-
Peak Hour Factor	91	91	91	91	91	91	91	91	91	91	91	91
Heavy Vehicles, %	2	2	2	2	2	2	2	2	2	2	2	2
Mvmt Flow	3	0	3	35	0	14	5	807	46	19	963	11

Major/Minor	Minor2			Minor1			Major1			Major2		
Conflicting Flow All	1855	1870	969	1848	1853	831	975	0	0	853	0	0
Stage 1	1006	1006	-	841	841	-	-	-	-	-	-	-
Stage 2	849	864	-	1007	1012	-	-	-	-	-	-	-
Critical Hdwy	7.12	6.52	6.22	7.12	6.52	6.22	4.12	-	-	4.12	-	-
Critical Hdwy Stg 1	6.12	5.52	-	6.12	5.52	-	-	-	-	-	-	-
Critical Hdwy Stg 2	6.12	5.52	-	6.12	5.52	-	-	-	-	-	-	-
Follow-up Hdwy	3.518	4.018	3.318	3.518	4.018	3.318	2.218	-	-	2.218	-	-
Pot Cap-1 Maneuver	57	72	308	57	74	370	707	-	-	786	-	-
Stage 1	291	319	-	359	380	-	-	-	-	-	-	-
Stage 2	356	371	-	290	317	-	-	-	-	-	-	-
Platoon blocked, %												
Mov Cap-1 Maneuver	53	70	308	55	72	370	707	-	-	785	-	-
Mov Cap-2 Maneuver	53	70	-	55	72	-	-	-	-	-	-	-
Stage 1	289	311	-	356	377	-	-	-	-	-	-	-
Stage 2	340	368	-	280	309	-	-	-	-	-	-	-

Approach	EB	WB	NB	SB
HCM Control Delay, s	48.1	124.2	0.1	0.2
HCM LOS	E	F		

Minor Lane/Major Mvmt	NBL	NBT	NBR	EBLn1	WBLn1	SBL	SBT	SBR
Capacity (veh/h)	707	-	-	90	73	785	-	-
HCM Lane V/C Ratio	0.008	-	-	0.073	0.677	0.024	-	-
HCM Control Delay (s)	10.1	-	-	48.1	124.2	9.7	-	-
HCM Lane LOS	B	-	-	E	F	A	-	-
HCM 95th %tile Q(veh)	0	-	-	0.2	3.1	0.1	-	-

Intersection

Int Delay, s/veh 3.9

Movement	EBL	EBT	EBR	WBL	WBT	WBR	NBL	NBT	NBR	SBL	SBT	SBR
Lane Configurations		↕			↕			↕			↕	
Traffic Vol, veh/h	13	35	2	0	34	4	9	7	6	3	8	12
Future Vol, veh/h	13	35	2	0	34	4	9	7	6	3	8	12
Conflicting Peds, #/hr	2	0	1	1	0	2	0	0	0	0	0	0
Sign Control	Free	Free	Free	Free	Free	Free	Stop	Stop	Stop	Stop	Stop	Stop
RT Channelized	-	-	None	-	-	None	-	-	None	-	-	None
Storage Length	-	-	-	-	-	-	-	-	-	-	-	-
Veh in Median Storage, #	-	0	-	-	0	-	-	0	-	-	0	-
Grade, %	-	0	-	-	0	-	-	0	-	-	0	-
Peak Hour Factor	79	79	79	79	79	79	79	79	79	79	79	79
Heavy Vehicles, %	0	3	0	0	0	0	0	0	0	33	0	0
Mvmt Flow	16	44	3	0	43	5	11	9	8	4	10	15

Major/Minor	Major1			Major2			Minor1			Minor2		
Conflicting Flow All	50	0	0	48	0	0	137	129	47	135	129	48
Stage 1	-	-	-	-	-	-	79	79	-	48	48	-
Stage 2	-	-	-	-	-	-	58	50	-	87	81	-
Critical Hdwy	4.1	-	-	4.1	-	-	7.1	6.5	6.2	7.43	6.5	6.2
Critical Hdwy Stg 1	-	-	-	-	-	-	6.1	5.5	-	6.43	5.5	-
Critical Hdwy Stg 2	-	-	-	-	-	-	6.1	5.5	-	6.43	5.5	-
Follow-up Hdwy	2.2	-	-	2.2	-	-	3.5	4	3.3	3.797	4	3.3
Pot Cap-1 Maneuver	1570	-	-	1572	-	-	838	765	1028	770	765	1027
Stage 1	-	-	-	-	-	-	935	833	-	892	859	-
Stage 2	-	-	-	-	-	-	959	857	-	849	832	-
Platoon blocked, %	-	-	-	-	-	-	-	-	-	-	-	-
Mov Cap-1 Maneuver	1570	-	-	1572	-	-	810	755	1027	750	755	1025
Mov Cap-2 Maneuver	-	-	-	-	-	-	810	755	-	750	755	-
Stage 1	-	-	-	-	-	-	925	824	-	881	857	-
Stage 2	-	-	-	-	-	-	934	855	-	825	823	-

Approach	EB	WB	NB	SB
HCM Control Delay, s	1.9	0	9.4	9.3
HCM LOS			A	A

Minor Lane/Major Mvmt	NBLn1	EBL	EBT	EBR	WBL	WBT	WBR	SBLn1
Capacity (veh/h)	839	1570	-	-	1572	-	-	874
HCM Lane V/C Ratio	0.033	0.01	-	-	-	-	-	0.033
HCM Control Delay (s)	9.4	7.3	0	-	0	-	-	9.3
HCM Lane LOS	A	A	A	-	A	-	-	A
HCM 95th %tile Q(veh)	0.1	0	-	-	0	-	-	0.1

Intersection

Int Delay, s/veh 7.5

Movement	EBL	EBT	EBR	WBL	WBT	WBR	NBL	NBT	NBR	SBL	SBT	SBR
Lane Configurations		↕			↕			↕			↕	
Traffic Vol, veh/h	0	39	3	9	33	2	4	6	5	15	12	2
Future Vol, veh/h	0	39	3	9	33	2	4	6	5	15	12	2
Conflicting Peds, #/hr	3	0	0	0	0	3	3	0	2	2	0	3
Sign Control	Stop	Stop	Stop	Stop	Stop	Stop	Free	Free	Free	Free	Free	Free
RT Channelized	-	-	None	-	-	None	-	-	None	-	-	None
Storage Length	-	-	-	-	-	-	-	-	-	-	-	-
Veh in Median Storage, #	-	0	-	-	0	-	-	0	-	-	0	-
Grade, %	-	0	-	-	0	-	-	0	-	-	0	-
Peak Hour Factor	86	86	86	86	86	86	86	86	86	86	86	86
Heavy Vehicles, %	0	5	0	22	0	0	0	0	0	0	8	0
Mvmt Flow	0	45	3	10	38	2	5	7	6	17	14	2

Major/Minor	Minor2			Minor1			Major1			Major2		
Conflicting Flow All	96	77	18	95	75	15	19	0	0	15	0	0
Stage 1	53	53	-	21	21	-	-	-	-	-	-	-
Stage 2	43	24	-	74	54	-	-	-	-	-	-	-
Critical Hdwy	7.1	6.55	6.2	7.32	6.5	6.2	4.1	-	-	4.1	-	-
Critical Hdwy Stg 1	6.1	5.55	-	6.32	5.5	-	-	-	-	-	-	-
Critical Hdwy Stg 2	6.1	5.55	-	6.32	5.5	-	-	-	-	-	-	-
Follow-up Hdwy	3.5	4.045	3.3	3.698	4	3.3	2.2	-	-	2.2	-	-
Pot Cap-1 Maneuver	891	808	1066	842	819	1070	1611	-	-	1616	-	-
Stage 1	965	845	-	948	882	-	-	-	-	-	-	-
Stage 2	976	869	-	888	854	-	-	-	-	-	-	-
Platoon blocked, %												
Mov Cap-1 Maneuver	843	793	1063	793	804	1065	1611	-	-	1611	-	-
Mov Cap-2 Maneuver	843	793	-	793	804	-	-	-	-	-	-	-
Stage 1	959	833	-	943	878	-	-	-	-	-	-	-
Stage 2	926	865	-	828	842	-	-	-	-	-	-	-

Approach	EB	WB	NB	SB
HCM Control Delay, s	9.7	9.7	1.9	3.8
HCM LOS	A	A		

Minor Lane/Major Mvmt	NBL	NBT	NBR	EBLn1WBLn1	SBL	SBT	SBR
Capacity (veh/h)	1611	-	-	808	811	1611	-
HCM Lane V/C Ratio	0.003	-	-	0.06	0.063	0.011	-
HCM Control Delay (s)	7.2	0	-	9.7	9.7	7.3	0
HCM Lane LOS	A	A	-	A	A	A	A
HCM 95th %tile Q(veh)	0	-	-	0.2	0.2	0	-

Intersection	
Intersection Delay, s/veh	7.3
Intersection LOS	A

Movement	EBU	EBL	EBT	EBR	WBU	WBL	WBT	WBR	NBU	NBL	NBT	NBR
Lane Configurations			↕				↕				↕	
Traffic Vol, veh/h	0	2	53	6	0	1	32	0	0	5	2	3
Future Vol, veh/h	0	2	53	6	0	1	32	0	0	5	2	3
Peak Hour Factor	0.92	0.75	0.75	0.75	0.92	0.75	0.75	0.75	0.92	0.75	0.75	0.75
Heavy Vehicles, %	2	0	4	0	2	0	0	0	2	40	0	0
Mvmt Flow	0	3	71	8	0	1	43	0	0	7	3	4
Number of Lanes	0	0	1	0	0	0	1	0	0	0	1	0

Approach	EB	WB	NB
Opposing Approach	WB	EB	SB
Opposing Lanes	1	1	1
Conflicting Approach Left	SB	NB	EB
Conflicting Lanes Left	1	1	1
Conflicting Approach Right	NB	SB	WB
Conflicting Lanes Right	1	1	1
HCM Control Delay	7.3	7.2	7.9
HCM LOS	A	A	A

Lane	NBLn1	EBLn1	WBLn1	SBLn1
Vol Left, %	50%	3%	3%	0%
Vol Thru, %	20%	87%	97%	0%
Vol Right, %	30%	10%	0%	100%
Sign Control	Stop	Stop	Stop	Stop
Traffic Vol by Lane	10	61	33	4
LT Vol	5	2	1	0
Through Vol	2	53	32	0
RT Vol	3	6	0	4
Lane Flow Rate	13	81	44	5
Geometry Grp	1	1	1	1
Degree of Util (X)	0.017	0.088	0.049	0.005
Departure Headway (Hd)	4.721	3.914	4	3.525
Convergence, Y/N	Yes	Yes	Yes	Yes
Cap	755	917	895	1006
Service Time	2.771	1.932	2.023	1.579
HCM Lane V/C Ratio	0.017	0.088	0.049	0.005
HCM Control Delay	7.9	7.3	7.2	6.6
HCM Lane LOS	A	A	A	A
HCM 95th-tile Q	0.1	0.3	0.2	0

Intersection

Intersection Delay, s/veh
 Intersection LOS

Movement	SBU	SBL	SBT	SBR
Lane Configurations			↕	
Traffic Vol, veh/h	0	0	0	4
Future Vol, veh/h	0	0	0	4
Peak Hour Factor	0.92	0.75	0.75	0.75
Heavy Vehicles, %	2	0	0	0
Mvmt Flow	0	0	0	5
Number of Lanes	0	0	1	0

Approach	SB
Opposing Approach	NB
Opposing Lanes	1
Conflicting Approach Left	WB
Conflicting Lanes Left	1
Conflicting Approach Right	EB
Conflicting Lanes Right	1
HCM Control Delay	6.6
HCM LOS	A

Intersection

Int Delay, s/veh 0.1

Movement	EBL	EBR	NBL	NBT	SBT	SBR
Lane Configurations	Y			Y	Y	
Traffic Vol, veh/h	1	2	8	765	905	1
Future Vol, veh/h	1	2	8	765	905	1
Conflicting Peds, #/hr	0	0	0	0	0	0
Sign Control	Stop	Stop	Free	Free	Free	Free
RT Channelized	-	None	-	None	-	None
Storage Length	0	-	-	-	-	-
Veh in Median Storage, #	0	-	-	0	0	-
Grade, %	0	-	-	0	0	-
Peak Hour Factor	91	91	91	91	91	92
Heavy Vehicles, %	2	2	2	2	2	2
Mvmt Flow	1	2	9	841	995	1

Major/Minor	Minor2		Major1		Major2	
Conflicting Flow All	1853	995	996	0	-	0
Stage 1	995	-	-	-	-	-
Stage 2	858	-	-	-	-	-
Critical Hdwy	6.42	6.22	4.12	-	-	-
Critical Hdwy Stg 1	5.42	-	-	-	-	-
Critical Hdwy Stg 2	5.42	-	-	-	-	-
Follow-up Hdwy	3.518	3.318	2.218	-	-	-
Pot Cap-1 Maneuver	81	297	695	-	-	-
Stage 1	358	-	-	-	-	-
Stage 2	415	-	-	-	-	-
Platoon blocked, %				-	-	-
Mov Cap-1 Maneuver	79	297	695	-	-	-
Mov Cap-2 Maneuver	79	-	-	-	-	-
Stage 1	358	-	-	-	-	-
Stage 2	405	-	-	-	-	-

Approach	EB	NB	SB
HCM Control Delay, s	28.7	0.1	0
HCM LOS	D		

Minor Lane/Major Mvmt	NBL	NBT	EBLn1	SBT	SBR
Capacity (veh/h)	695	-	155	-	-
HCM Lane V/C Ratio	0.013	-	0.021	-	-
HCM Control Delay (s)	10.2	0	28.7	-	-
HCM Lane LOS	B	A	D	-	-
HCM 95th %tile Q(veh)	0	-	0.1	-	-

Intersection

Int Delay, s/veh 0.3

Movement	WBL	WBR	NBT	NBR	SBL	SBT
Lane Configurations	↘↗		↑	↗		↖
Traffic Vol, veh/h	7	3	764	9	4	983
Future Vol, veh/h	7	3	764	9	4	983
Conflicting Peds, #/hr	0	0	0	1	1	0
Sign Control	Stop	Stop	Free	Free	Free	Free
RT Channelized	-	None	-	None	-	None
Storage Length	0	-	-	125	-	-
Veh in Median Storage, #	0	-	0	-	-	0
Grade, %	0	-	0	-	-	0
Peak Hour Factor	96	96	96	96	96	96
Heavy Vehicles, %	0	0	2	0	0	1
Mvmt Flow	7	3	796	9	4	1024

Major/Minor	Minor1		Major1		Major2	
Conflicting Flow All	1829	797	0	0	797	0
Stage 1	797	-	-	-	-	-
Stage 2	1032	-	-	-	-	-
Critical Hdwy	7.1	6.2	-	-	4.1	-
Critical Hdwy Stg 1	6.1	-	-	-	-	-
Critical Hdwy Stg 2	6.1	-	-	-	-	-
Follow-up Hdwy	3.5	3.3	-	-	2.2	-
Pot Cap-1 Maneuver	60	390	-	-	834	-
Stage 1	383	-	-	-	-	-
Stage 2	284	-	-	-	-	-
Platoon blocked, %			-	-		
Mov Cap-1 Maneuver	59	390	-	-	834	-
Mov Cap-2 Maneuver	59	-	-	-	-	-
Stage 1	383	-	-	-	-	-
Stage 2	281	-	-	-	-	-

Approach	WB		NB		SB
HCM Control Delay, s	57.4		0		0
HCM LOS	F				

Minor Lane/Major Mvmt	NBT	NBRWBLn1	SBL	SBT
Capacity (veh/h)	-	-	79	834
HCM Lane V/C Ratio	-	-	0.132	0.005
HCM Control Delay (s)	-	-	57.4	9.3
HCM Lane LOS	-	-	F	A
HCM 95th %tile Q(veh)	-	-	0.4	0

Intersection

Int Delay, s/veh 0

Movement	EBL	EBT	EBR	WBL	WBT	WBR	NBL	NBT	NBR	SBL	SBT	SBR
Lane Configurations		↔			↔		↑	↑		↑	↑	
Traffic Vol, veh/h	0	0	0	1	0	1	2	763	0	1	992	4
Future Vol, veh/h	0	0	0	1	0	1	2	763	0	1	992	4
Conflicting Peds, #/hr	0	0	1	1	0	0	0	0	3	3	0	0
Sign Control	Stop	Stop	Stop	Stop	Stop	Stop	Free	Free	Free	Free	Free	Free
RT Channelized	-	-	None	-	-	None	-	-	None	-	-	None
Storage Length	-	-	-	-	-	-	65	-	-	50	-	-
Veh in Median Storage, #	-	0	-	-	0	-	-	0	-	-	0	-
Grade, %	-	0	-	-	0	-	-	0	-	-	0	-
Peak Hour Factor	96	96	96	96	96	96	96	96	96	96	96	96
Heavy Vehicles, %	0	0	0	0	0	0	0	3	0	0	2	0
Mvmt Flow	0	0	0	1	0	1	2	795	0	1	1033	4

Major/Minor	Minor2			Minor1			Major1			Major2		
Conflicting Flow All	1837	1840	1036	1841	1842	798	1038	0	0	798	0	0
Stage 1	1038	1038	-	802	802	-	-	-	-	-	-	-
Stage 2	799	802	-	1039	1040	-	-	-	-	-	-	-
Critical Hdwy	7.1	6.5	6.2	7.1	6.5	6.2	4.1	-	-	4.1	-	-
Critical Hdwy Stg 1	6.1	5.5	-	6.1	5.5	-	-	-	-	-	-	-
Critical Hdwy Stg 2	6.1	5.5	-	6.1	5.5	-	-	-	-	-	-	-
Follow-up Hdwy	3.5	4	3.3	3.5	4	3.3	2.2	-	-	2.2	-	-
Pot Cap-1 Maneuver	59	76	284	59	76	389	678	-	-	833	-	-
Stage 1	281	311	-	381	399	-	-	-	-	-	-	-
Stage 2	382	399	-	281	310	-	-	-	-	-	-	-
Platoon blocked, %												
Mov Cap-1 Maneuver	59	75	284	59	75	388	677	-	-	833	-	-
Mov Cap-2 Maneuver	59	75	-	59	75	-	-	-	-	-	-	-
Stage 1	280	311	-	379	397	-	-	-	-	-	-	-
Stage 2	380	397	-	280	310	-	-	-	-	-	-	-

Approach	EB	WB	NB	SB
HCM Control Delay, s	0	41	0	0
HCM LOS	A	E		

Minor Lane/Major Mvmt	NBL	NBT	NBR	EBLn1	WBLn1	SBL	SBT	SBR
Capacity (veh/h)	677	-	-	-	102	833	-	-
HCM Lane V/C Ratio	0.003	-	-	-	0.02	0.001	-	-
HCM Control Delay (s)	10.3	-	-	0	41	9.3	-	-
HCM Lane LOS	B	-	-	A	E	A	-	-
HCM 95th %tile Q(veh)	0	-	-	-	0.1	0	-	-

Intersection

Int Delay, s/veh 0.7

Movement	WBL	WBR	NBT	NBR	SBL	SBT
Lane Configurations	Y		P		T	T
Traffic Vol, veh/h	10	19	749	8	19	973
Future Vol, veh/h	10	19	749	8	19	973
Conflicting Peds, #/hr	0	0	0	1	1	0
Sign Control	Stop	Stop	Free	Free	Free	Free
RT Channelized	-	None	-	None	-	None
Storage Length	0	-	-	-	65	-
Veh in Median Storage, #	0	-	0	-	-	0
Grade, %	0	-	0	-	-	0
Peak Hour Factor	93	93	93	93	93	93
Heavy Vehicles, %	0	9	2	0	0	1
Mvmt Flow	11	20	805	9	20	1046

Major/Minor	Minor1		Major1		Major2	
Conflicting Flow All	1898	811	0	0	815	0
Stage 1	811	-	-	-	-	-
Stage 2	1087	-	-	-	-	-
Critical Hdwy	6.4	6.29	-	-	4.1	-
Critical Hdwy Stg 1	5.4	-	-	-	-	-
Critical Hdwy Stg 2	5.4	-	-	-	-	-
Follow-up Hdwy	3.5	3.381	-	-	2.2	-
Pot Cap-1 Maneuver	77	369	-	-	821	-
Stage 1	440	-	-	-	-	-
Stage 2	326	-	-	-	-	-
Platoon blocked, %			-	-		
Mov Cap-1 Maneuver	75	369	-	-	821	-
Mov Cap-2 Maneuver	75	-	-	-	-	-
Stage 1	440	-	-	-	-	-
Stage 2	318	-	-	-	-	-

Approach	WB		NB		SB
HCM Control Delay, s	33.5		0		0.2
HCM LOS	D				

Minor Lane/Major Mvmt	NBT	NBRWBLn1	SBL	SBT
Capacity (veh/h)	-	- 157	821	-
HCM Lane V/C Ratio	-	- 0.199	0.025	-
HCM Control Delay (s)	-	- 33.5	9.5	-
HCM Lane LOS	-	- D	A	-
HCM 95th %tile Q(veh)	-	- 0.7	0.1	-

Intersection

Int Delay, s/veh 6.7

Movement	WBL	WBR	NBT	NBR	SBL	SBT
Lane Configurations	Y		P			A
Traffic Vol, veh/h	3	13	1	2	6	2
Future Vol, veh/h	3	13	1	2	6	2
Conflicting Peds, #/hr	2	0	0	0	0	0
Sign Control	Stop	Stop	Free	Free	Free	Free
RT Channelized	-	None	-	None	-	None
Storage Length	0	-	-	-	-	-
Veh in Median Storage, #	0	-	0	-	-	0
Grade, %	0	-	0	-	-	0
Peak Hour Factor	75	75	75	75	75	75
Heavy Vehicles, %	33	8	0	0	0	0
Mvmt Flow	4	17	1	3	8	3

Major/Minor	Minor1		Major1		Major2	
Conflicting Flow All	24	3	0	0	4	0
Stage 1	3	-	-	-	-	-
Stage 2	21	-	-	-	-	-
Critical Hdwy	6.73	6.28	-	-	4.1	-
Critical Hdwy Stg 1	5.73	-	-	-	-	-
Critical Hdwy Stg 2	5.73	-	-	-	-	-
Follow-up Hdwy	3.797	3.372	-	-	2.2	-
Pot Cap-1 Maneuver	918	1064	-	-	1631	-
Stage 1	945	-	-	-	-	-
Stage 2	927	-	-	-	-	-
Platoon blocked, %			-	-		-
Mov Cap-1 Maneuver	912	1064	-	-	1631	-
Mov Cap-2 Maneuver	912	-	-	-	-	-
Stage 1	945	-	-	-	-	-
Stage 2	921	-	-	-	-	-

Approach	WB		NB		SB
HCM Control Delay, s	8.6		0		5.4
HCM LOS	A				

Minor Lane/Major Mvmt	NBT	NBRWBLn1	SBL	SBT
Capacity (veh/h)	-	- 1032	1631	-
HCM Lane V/C Ratio	-	- 0.021	0.005	-
HCM Control Delay (s)	-	- 8.6	7.2	0
HCM Lane LOS	-	- A	A	A
HCM 95th %tile Q(veh)	-	- 0.1	0	-

Intersection

Int Delay, s/veh 5.9

Movement	EBT	EBR	WBL	WBT	NBL	NBR
Lane Configurations	↔			↔	↔	
Traffic Vol, veh/h	2	5	1	0	13	1
Future Vol, veh/h	2	5	1	0	13	1
Conflicting Peds, #/hr	0	1	1	0	0	0
Sign Control	Free	Free	Free	Free	Stop	Stop
RT Channelized	-	None	-	None	-	None
Storage Length	-	-	-	-	0	-
Veh in Median Storage, #	0	-	-	0	0	-
Grade, %	0	-	-	0	0	-
Peak Hour Factor	79	79	79	79	79	79
Heavy Vehicles, %	0	0	100	0	15	0
Mvmt Flow	3	6	1	0	16	1

Major/Minor	Major1	Major2	Minor1	Minor2
Conflicting Flow All	0	0	10	0
Stage 1	-	-	-	-
Stage 2	-	-	-	-
Critical Hdwy	-	-	5.1	-
Critical Hdwy Stg 1	-	-	-	-
Critical Hdwy Stg 2	-	-	-	-
Follow-up Hdwy	-	-	3.1	-
Pot Cap-1 Maneuver	-	-	1150	-
Stage 1	-	-	-	-
Stage 2	-	-	-	-
Platoon blocked, %	-	-	-	-
Mov Cap-1 Maneuver	-	-	1150	-
Mov Cap-2 Maneuver	-	-	-	-
Stage 1	-	-	-	-
Stage 2	-	-	-	-

Approach	EB	WB	NB
HCM Control Delay, s	0	8.1	8.7
HCM LOS			A

Minor Lane/Major Mvmt	NBLn1	EBT	EBR	WBL	WBT
Capacity (veh/h)	982	-	-	1150	-
HCM Lane V/C Ratio	0.018	-	-	0.001	-
HCM Control Delay (s)	8.7	-	-	8.1	0
HCM Lane LOS	A	-	-	A	A
HCM 95th %tile Q(veh)	0.1	-	-	0	-

Intersection

Int Delay, s/veh 0.8

Movement	EBL	EBT	EBR	WBL	WBT	WBR	NBL	NBT	NBR	SBL	SBT	SBR
Lane Configurations		↕			↕		↕	↕		↕	↕	
Traffic Vol, veh/h	0	0	6	6	1	25	9	736	2	22	953	5
Future Vol, veh/h	0	0	6	6	1	25	9	736	2	22	953	5
Conflicting Peds, #/hr	0	0	0	0	0	0	0	0	1	1	0	0
Sign Control	Stop	Stop	Stop	Stop	Stop	Stop	Free	Free	Free	Free	Free	Free
RT Channelized	-	-	None	-	-	None	-	-	None	-	-	None
Storage Length	-	-	-	-	-	-	125	-	-	125	-	-
Veh in Median Storage, #	-	0	-	-	0	-	-	0	-	-	0	-
Grade, %	-	0	-	-	0	-	-	0	-	-	0	-
Peak Hour Factor	95	95	95	95	95	95	95	95	95	95	95	95
Heavy Vehicles, %	0	0	0	17	0	4	0	3	0	5	1	0
Mvmt Flow	0	0	6	6	1	26	9	775	2	23	1003	5

Major/Minor	Minor2			Minor1			Major1			Major2		
Conflicting Flow All	1860	1849	1006	1851	1851	777	1008	0	0	778	0	0
Stage 1	1052	1052	-	796	796	-	-	-	-	-	-	-
Stage 2	808	797	-	1055	1055	-	-	-	-	-	-	-
Critical Hdwy	7.1	6.5	6.2	7.27	6.5	6.24	4.1	-	-	4.15	-	-
Critical Hdwy Stg 1	6.1	5.5	-	6.27	5.5	-	-	-	-	-	-	-
Critical Hdwy Stg 2	6.1	5.5	-	6.27	5.5	-	-	-	-	-	-	-
Follow-up Hdwy	3.5	4	3.3	3.653	4	3.336	2.2	-	-	2.245	-	-
Pot Cap-1 Maneuver	57	75	295	52	75	394	695	-	-	825	-	-
Stage 1	276	306	-	359	402	-	-	-	-	-	-	-
Stage 2	378	401	-	256	305	-	-	-	-	-	-	-
Platoon blocked, %												
Mov Cap-1 Maneuver	51	72	295	49	72	394	695	-	-	825	-	-
Mov Cap-2 Maneuver	51	72	-	49	72	-	-	-	-	-	-	-
Stage 1	272	297	-	354	396	-	-	-	-	-	-	-
Stage 2	347	395	-	244	296	-	-	-	-	-	-	-

Approach	EB	WB	NB	SB
HCM Control Delay, s	17.5	33.4	0.1	0.2
HCM LOS	C	D		

Minor Lane/Major Mvmt	NBL	NBT	NBR	EBLn1	WBLn1	SBL	SBT	SBR
Capacity (veh/h)	695	-	-	295	160	825	-	-
HCM Lane V/C Ratio	0.014	-	-	0.021	0.211	0.028	-	-
HCM Control Delay (s)	10.3	-	-	17.5	33.4	9.5	-	-
HCM Lane LOS	B	-	-	C	D	A	-	-
HCM 95th %tile Q(veh)	0	-	-	0.1	0.8	0.1	-	-

Intersection

Int Delay, s/veh 3.7

Movement	EBL	EBT	EBR	WBL	WBT	WBR	NBL	NBT	NBR	SBL	SBT	SBR
Lane Configurations		↔			↔		↔	↔		↔	↔	
Traffic Vol, veh/h	6	3	21	23	3	23	28	720	36	7	953	7
Future Vol, veh/h	6	3	21	23	3	23	28	720	36	7	953	7
Conflicting Peds, #/hr	1	0	0	0	0	1	0	0	0	0	0	0
Sign Control	Stop	Stop	Stop	Stop	Stop	Stop	Free	Free	Free	Free	Free	Free
RT Channelized	-	-	None	-	-	None	-	-	None	-	-	None
Storage Length	-	-	-	-	-	-	80	-	-	125	-	-
Veh in Median Storage, #	-	0	-	-	0	-	-	0	-	-	0	-
Grade, %	-	0	-	-	0	-	-	0	-	-	0	-
Peak Hour Factor	95	95	95	95	95	95	95	95	95	95	95	95
Heavy Vehicles, %	2	2	2	2	2	2	2	2	2	2	2	2
Mvmt Flow	6	3	22	24	3	24	29	758	38	7	1003	7

Major/Minor	Minor2			Minor1			Major1			Major2		
Conflicting Flow All	1872	1877	1007	1870	1861	778	1011	0	0	796	0	0
Stage 1	1022	1022	-	836	836	-	-	-	-	-	-	-
Stage 2	850	855	-	1034	1025	-	-	-	-	-	-	-
Critical Hdwy	7.12	6.52	6.22	7.12	6.52	6.22	4.12	-	-	4.12	-	-
Critical Hdwy Stg 1	6.12	5.52	-	6.12	5.52	-	-	-	-	-	-	-
Critical Hdwy Stg 2	6.12	5.52	-	6.12	5.52	-	-	-	-	-	-	-
Follow-up Hdwy	3.518	4.018	3.318	3.518	4.018	3.318	2.218	-	-	2.218	-	-
Pot Cap-1 Maneuver	55	71	292	55	73	396	686	-	-	826	-	-
Stage 1	285	313	-	362	382	-	-	-	-	-	-	-
Stage 2	355	375	-	280	312	-	-	-	-	-	-	-
Platoon blocked, %												
Mov Cap-1 Maneuver	48	67	292	47	69	396	686	-	-	825	-	-
Mov Cap-2 Maneuver	48	67	-	47	69	-	-	-	-	-	-	-
Stage 1	273	310	-	347	366	-	-	-	-	-	-	-
Stage 2	316	359	-	254	309	-	-	-	-	-	-	-

Approach	EB	WB	NB	SB
HCM Control Delay, s	43.7	102.4	0.4	0.1
HCM LOS	E	F		

Minor Lane/Major Mvmt	NBL	NBT	NBR	EBLn1	WBLn1	SBL	SBT	SBR
Capacity (veh/h)	686	-	-	124	83	825	-	-
HCM Lane V/C Ratio	0.043	-	-	0.255	0.621	0.009	-	-
HCM Control Delay (s)	10.5	-	-	43.7	102.4	9.4	-	-
HCM Lane LOS	B	-	-	E	F	A	-	-
HCM 95th %tile Q(veh)	0.1	-	-	0.9	2.9	0	-	-

Intersection

Int Delay, s/veh 4.5

Movement	EBL	EBT	EBR	WBL	WBT	WBR	NBL	NBT	NBR	SBL	SBT	SBR
Lane Configurations		↕			↕			↕			↕	
Traffic Vol, veh/h	25	33	2	5	31	17	10	9	3	6	17	8
Future Vol, veh/h	25	33	2	5	31	17	10	9	3	6	17	8
Conflicting Peds, #/hr	1	0	0	0	0	1	0	0	2	2	0	0
Sign Control	Free	Free	Free	Free	Free	Free	Stop	Stop	Stop	Stop	Stop	Stop
RT Channelized	-	-	None	-	-	None	-	-	None	-	-	None
Storage Length	-	-	-	-	-	-	-	-	-	-	-	-
Veh in Median Storage, #	-	0	-	-	0	-	-	0	-	-	0	-
Grade, %	-	0	-	-	0	-	-	0	-	-	0	-
Peak Hour Factor	83	83	83	83	83	83	83	83	83	83	83	83
Heavy Vehicles, %	0	0	0	0	0	0	0	0	0	0	0	0
Mvmt Flow	30	40	2	6	37	20	12	11	4	7	20	10

Major/Minor	Major1			Major2			Minor1			Minor2		
Conflicting Flow All	59	0	0	42	0	0	176	172	43	171	163	49
Stage 1	-	-	-	-	-	-	101	101	-	61	61	-
Stage 2	-	-	-	-	-	-	75	71	-	110	102	-
Critical Hdwy	4.1	-	-	4.1	-	-	7.1	6.5	6.2	7.1	6.5	6.2
Critical Hdwy Stg 1	-	-	-	-	-	-	6.1	5.5	-	6.1	5.5	-
Critical Hdwy Stg 2	-	-	-	-	-	-	6.1	5.5	-	6.1	5.5	-
Follow-up Hdwy	2.2	-	-	2.2	-	-	3.5	4	3.3	3.5	4	3.3
Pot Cap-1 Maneuver	1558	-	-	1580	-	-	791	725	1033	797	733	1025
Stage 1	-	-	-	-	-	-	910	815	-	955	848	-
Stage 2	-	-	-	-	-	-	939	840	-	900	815	-
Platoon blocked, %	-	-	-	-	-	-	-	-	-	-	-	-
Mov Cap-1 Maneuver	1558	-	-	1577	-	-	752	707	1031	768	715	1024
Mov Cap-2 Maneuver	-	-	-	-	-	-	752	707	-	768	715	-
Stage 1	-	-	-	-	-	-	892	799	-	935	844	-
Stage 2	-	-	-	-	-	-	904	836	-	865	799	-

Approach	EB	WB	NB	SB
HCM Control Delay, s	3.1	0.7	9.9	9.8
HCM LOS			A	A

Minor Lane/Major Mvmt	NBLn1	EBL	EBT	EBR	WBL	WBT	WBR	SBLn1
Capacity (veh/h)	760	1558	-	-	1577	-	-	787
HCM Lane V/C Ratio	0.035	0.019	-	-	0.004	-	-	0.047
HCM Control Delay (s)	9.9	7.4	0	-	7.3	0	-	9.8
HCM Lane LOS	A	A	A	-	A	A	-	A
HCM 95th %tile Q(veh)	0.1	0.1	-	-	0	-	-	0.1

Intersection

Int Delay, s/veh 6.9

Movement	EBL	EBT	EBR	WBL	WBT	WBR	NBL	NBT	NBR	SBL	SBT	SBR
Lane Configurations		↕			↕			↕			↕	
Traffic Vol, veh/h	2	37	3	10	37	2	7	13	7	8	16	3
Future Vol, veh/h	2	37	3	10	37	2	7	13	7	8	16	3
Conflicting Peds, #/hr	4	0	0	0	0	4	1	0	1	1	0	1
Sign Control	Stop	Stop	Stop	Stop	Stop	Stop	Free	Free	Free	Free	Free	Free
RT Channelized	-	-	None	-	-	None	-	-	None	-	-	None
Storage Length	-	-	-	-	-	-	-	-	-	-	-	-
Veh in Median Storage, #	-	0	-	-	0	-	-	0	-	-	0	-
Grade, %	-	0	-	-	0	-	-	0	-	-	0	-
Peak Hour Factor	84	84	84	84	84	84	84	84	84	84	84	84
Heavy Vehicles, %	0	0	0	0	0	0	0	8	14	0	6	0
Mvmt Flow	2	44	4	12	44	2	8	15	8	10	19	4

Major/Minor	Minor2			Minor1			Major1			Major2		
Conflicting Flow All	105	82	22	101	80	25	24	0	0	25	0	0
Stage 1	41	41	-	37	37	-	-	-	-	-	-	-
Stage 2	64	41	-	64	43	-	-	-	-	-	-	-
Critical Hdwy	7.1	6.5	6.2	7.1	6.5	6.2	4.1	-	-	4.1	-	-
Critical Hdwy Stg 1	6.1	5.5	-	6.1	5.5	-	-	-	-	-	-	-
Critical Hdwy Stg 2	6.1	5.5	-	6.1	5.5	-	-	-	-	-	-	-
Follow-up Hdwy	3.5	4	3.3	3.5	4	3.3	2.2	-	-	2.2	-	-
Pot Cap-1 Maneuver	880	812	1061	885	814	1057	1604	-	-	1603	-	-
Stage 1	979	865	-	984	868	-	-	-	-	-	-	-
Stage 2	952	865	-	952	863	-	-	-	-	-	-	-
Platoon blocked, %												
Mov Cap-1 Maneuver	830	802	1060	837	804	1052	1604	-	-	1597	-	-
Mov Cap-2 Maneuver	830	802	-	837	804	-	-	-	-	-	-	-
Stage 1	973	859	-	978	863	-	-	-	-	-	-	-
Stage 2	893	860	-	895	857	-	-	-	-	-	-	-

Approach	EB	WB	NB	SB
HCM Control Delay, s	9.7	9.7	1.9	2.2
HCM LOS	A	A		

Minor Lane/Major Mvmt	NBL	NBT	NBR	EBLn1	WBLn1	SBL	SBT	SBR
Capacity (veh/h)	1604	-	-	818	818	1597	-	-
HCM Lane V/C Ratio	0.005	-	-	0.061	0.071	0.006	-	-
HCM Control Delay (s)	7.3	0	-	9.7	9.7	7.3	0	-
HCM Lane LOS	A	A	-	A	A	A	A	-
HCM 95th %tile Q(veh)	0	-	-	0.2	0.2	0	-	-

Intersection	
Intersection Delay, s/veh	7.2
Intersection LOS	A

Movement	EBU	EBL	EBT	EBR	WBU	WBL	WBT	WBR	NBU	NBL	NBT	NBR
Lane Configurations			↕				↕				↕	
Traffic Vol, veh/h	0	4	45	3	0	2	40	0	0	4	1	4
Future Vol, veh/h	0	4	45	3	0	2	40	0	0	4	1	4
Peak Hour Factor	0.92	0.83	0.83	0.83	0.92	0.83	0.83	0.83	0.92	0.83	0.83	0.83
Heavy Vehicles, %	2	0	2	0	2	0	0	0	2	0	0	0
Mvmt Flow	0	5	54	4	0	2	48	0	0	5	1	5
Number of Lanes	0	0	1	0	0	0	1	0	0	0	1	0

Approach	EB	WB	NB
Opposing Approach	WB	EB	SB
Opposing Lanes	1	1	1
Conflicting Approach Left	SB	NB	EB
Conflicting Lanes Left	1	1	1
Conflicting Approach Right	NB	SB	WB
Conflicting Lanes Right	1	1	1
HCM Control Delay	7.3	7.2	7
HCM LOS	A	A	A

Lane	NBLn1	EBLn1	WBLn1	SBLn1
Vol Left, %	44%	8%	5%	0%
Vol Thru, %	11%	87%	95%	14%
Vol Right, %	44%	6%	0%	86%
Sign Control	Stop	Stop	Stop	Stop
Traffic Vol by Lane	9	52	42	7
LT Vol	4	4	2	0
Through Vol	1	45	40	1
RT Vol	4	3	0	6
Lane Flow Rate	11	63	51	8
Geometry Grp	1	1	1	1
Degree of Util (X)	0.012	0.069	0.056	0.008
Departure Headway (Hd)	3.924	3.952	3.99	3.59
Convergence, Y/N	Yes	Yes	Yes	Yes
Cap	907	908	899	990
Service Time	1.971	1.967	2.007	1.638
HCM Lane V/C Ratio	0.012	0.069	0.057	0.008
HCM Control Delay	7	7.3	7.2	6.7
HCM Lane LOS	A	A	A	A
HCM 95th-tile Q	0	0.2	0.2	0

Intersection				
Intersection Delay, s/veh				
Intersection LOS				
Movement	SBU	SBL	SBT	SBR
Lane Configurations			↔	
Traffic Vol, veh/h	0	0	1	6
Future Vol, veh/h	0	0	1	6
Peak Hour Factor	0.92	0.83	0.83	0.83
Heavy Vehicles, %	2	0	0	0
Mvmt Flow	0	0	1	7
Number of Lanes	0	0	1	0
Approach			SB	
Opposing Approach			NB	
Opposing Lanes			1	
Conflicting Approach Left			WB	
Conflicting Lanes Left			1	
Conflicting Approach Right			EB	
Conflicting Lanes Right			1	
HCM Control Delay			6.7	
HCM LOS			A	

Intersection

Int Delay, s/veh 0.2

Movement	EBL	EBR	NBL	NBT	SBT	SBR
Lane Configurations	Y			Y	Y	
Traffic Vol, veh/h	3	8	4	747	960	5
Future Vol, veh/h	3	8	4	747	960	5
Conflicting Peds, #/hr	0	0	1	0	0	1
Sign Control	Stop	Stop	Free	Free	Free	Free
RT Channelized	-	None	-	None	-	None
Storage Length	0	-	-	-	-	-
Veh in Median Storage, #	0	-	-	0	0	-
Grade, %	0	-	-	0	0	-
Peak Hour Factor	95	95	95	95	95	95
Heavy Vehicles, %	2	2	2	2	2	2
Mvmt Flow	3	8	4	786	1011	5

Major/Minor	Minor2	Major1		Major2	
Conflicting Flow All	1809	1014	1017	0	0
Stage 1	1014	-	-	-	-
Stage 2	795	-	-	-	-
Critical Hdwy	6.42	6.22	4.12	-	-
Critical Hdwy Stg 1	5.42	-	-	-	-
Critical Hdwy Stg 2	5.42	-	-	-	-
Follow-up Hdwy	3.518	3.318	2.218	-	-
Pot Cap-1 Maneuver	87	290	682	-	-
Stage 1	350	-	-	-	-
Stage 2	445	-	-	-	-
Platoon blocked, %				-	-
Mov Cap-1 Maneuver	86	290	682	-	-
Mov Cap-2 Maneuver	86	-	-	-	-
Stage 1	350	-	-	-	-
Stage 2	440	-	-	-	-

Approach	EB	NB	SB
HCM Control Delay, s	26.9	0.1	0
HCM LOS	D		

Minor Lane/Major Mvmt	NBL	NBT	EBLn1	SBT	SBR
Capacity (veh/h)	682	-	176	-	-
HCM Lane V/C Ratio	0.006	-	0.066	-	-
HCM Control Delay (s)	10.3	0	26.9	-	-
HCM Lane LOS	B	A	D	-	-
HCM 95th %tile Q(veh)	0	-	0.2	-	-

APPENDIX 7. CUMULATIVE OPERATIONS RESULTS

Intersection

Int Delay, s/veh 0.8

Movement	WBL	WBR	NBT	NBR	SBL	SBT
Lane Configurations	↘↙		↑	↗		↖
Traffic Vol, veh/h	17	9	857	18	2	954
Future Vol, veh/h	17	9	857	18	2	954
Conflicting Peds, #/hr	0	0	0	0	0	0
Sign Control	Stop	Stop	Free	Free	Free	Free
RT Channelized	-	None	-	None	-	None
Storage Length	0	-	-	125	-	-
Veh in Median Storage, #	0	-	0	-	-	0
Grade, %	0	-	0	-	-	0
Peak Hour Factor	92	92	92	92	92	92
Heavy Vehicles, %	0	0	6	0	0	4
Mvmt Flow	18	10	932	20	2	1037

Major/Minor	Minor1		Major1		Major2	
Conflicting Flow All	1973	932	0	0	932	0
Stage 1	932	-	-	-	-	-
Stage 2	1041	-	-	-	-	-
Critical Hdwy	6.4	6.2	-	-	4.1	-
Critical Hdwy Stg 1	5.4	-	-	-	-	-
Critical Hdwy Stg 2	5.4	-	-	-	-	-
Follow-up Hdwy	3.5	3.3	-	-	2.2	-
Pot Cap-1 Maneuver	69	326	-	-	743	-
Stage 1	386	-	-	-	-	-
Stage 2	343	-	-	-	-	-
Platoon blocked, %			-	-		
Mov Cap-1 Maneuver	69	326	-	-	743	-
Mov Cap-2 Maneuver	69	-	-	-	-	-
Stage 1	386	-	-	-	-	-
Stage 2	341	-	-	-	-	-

Approach	WB		NB		SB
HCM Control Delay, s	58.2		0		0
HCM LOS	F				

Minor Lane/Major Mvmt	NBT	NBRWBLn1	SBL	SBT
Capacity (veh/h)	-	-	95	743
HCM Lane V/C Ratio	-	-	0.297	0.003
HCM Control Delay (s)	-	-	58.2	9.9
HCM Lane LOS	-	-	F	A
HCM 95th %tile Q(veh)	-	-	1.1	0

Intersection

Int Delay, s/veh 0.3

Movement	EBL	EBT	EBR	WBL	WBT	WBR	NBL	NBT	NBR	SBL	SBT	SBR
Lane Configurations		↔			↔		↑	↑		↑	↑	
Traffic Vol, veh/h	5	0	2	0	0	0	0	863	0	0	997	5
Future Vol, veh/h	5	0	2	0	0	0	0	863	0	0	997	5
Conflicting Peds, #/hr	1	0	0	0	0	1	1	0	1	1	0	1
Sign Control	Stop	Stop	Stop	Stop	Stop	Stop	Free	Free	Free	Free	Free	Free
RT Channelized	-	-	None	-	-	None	-	-	None	-	-	None
Storage Length	-	-	-	-	-	-	65	-	-	50	-	-
Veh in Median Storage, #	-	0	-	-	0	-	-	0	-	-	0	-
Grade, %	-	0	-	-	0	-	-	0	-	-	0	-
Peak Hour Factor	93	93	93	93	93	93	93	93	93	93	93	93
Heavy Vehicles, %	0	0	0	0	0	0	0	6	0	0	4	0
Mvmt Flow	5	0	2	0	0	0	0	928	0	0	1072	5

Major/Minor	Minor2			Minor1			Major1			Major2		
Conflicting Flow All	2005	2005	1076	2005	2007	930	1078	0	0	929	0	0
Stage 1	1076	1076	-	929	929	-	-	-	-	-	-	-
Stage 2	929	929	-	1076	1078	-	-	-	-	-	-	-
Critical Hdwy	7.1	6.5	6.2	7.1	6.5	6.2	4.1	-	-	4.1	-	-
Critical Hdwy Stg 1	6.1	5.5	-	6.1	5.5	-	-	-	-	-	-	-
Critical Hdwy Stg 2	6.1	5.5	-	6.1	5.5	-	-	-	-	-	-	-
Follow-up Hdwy	3.5	4	3.3	3.5	4	3.3	2.2	-	-	2.2	-	-
Pot Cap-1 Maneuver	45	60	269	45	60	327	655	-	-	744	-	-
Stage 1	268	298	-	324	349	-	-	-	-	-	-	-
Stage 2	324	349	-	268	297	-	-	-	-	-	-	-
Platoon blocked, %												
Mov Cap-1 Maneuver	45	60	269	45	60	326	655	-	-	743	-	-
Mov Cap-2 Maneuver	45	60	-	45	60	-	-	-	-	-	-	-
Stage 1	268	298	-	324	349	-	-	-	-	-	-	-
Stage 2	324	349	-	266	297	-	-	-	-	-	-	-

Approach	EB	WB	NB	SB
HCM Control Delay, s	74.7	0	0	0
HCM LOS	F	A		

Minor Lane/Major Mvmt	NBL	NBT	NBR	EBLn1WBLn1	SBL	SBT	SBR
Capacity (veh/h)	655	-	-	59	-	743	-
HCM Lane V/C Ratio	-	-	-	0.128	-	-	-
HCM Control Delay (s)	0	-	-	74.7	0	0	-
HCM Lane LOS	A	-	-	F	A	A	-
HCM 95th %tile Q(veh)	0	-	-	0.4	-	0	-

Intersection

Int Delay, s/veh 0.3

Movement	WBL	WBR	NBT	NBR	SBL	SBT
Lane Configurations	↘		↗		↘	↗
Traffic Vol, veh/h	0	27	809	0	6	980
Future Vol, veh/h	0	27	809	0	6	980
Conflicting Peds, #/hr	0	0	0	0	0	0
Sign Control	Stop	Stop	Free	Free	Free	Free
RT Channelized	-	None	-	None	-	None
Storage Length	0	-	-	-	65	-
Veh in Median Storage, #	0	-	0	-	-	0
Grade, %	0	-	0	-	-	0
Peak Hour Factor	92	92	92	92	92	92
Heavy Vehicles, %	0	0	6	0	0	4
Mvmt Flow	0	29	879	0	7	1065

Major/Minor	Minor1		Major1		Major2	
Conflicting Flow All	1957	879	0	0	879	0
Stage 1	879	-	-	-	-	-
Stage 2	1078	-	-	-	-	-
Critical Hdwy	6.4	6.2	-	-	4.1	-
Critical Hdwy Stg 1	5.4	-	-	-	-	-
Critical Hdwy Stg 2	5.4	-	-	-	-	-
Follow-up Hdwy	3.5	3.3	-	-	2.2	-
Pot Cap-1 Maneuver	71	350	-	-	777	-
Stage 1	409	-	-	-	-	-
Stage 2	330	-	-	-	-	-
Platoon blocked, %			-	-		
Mov Cap-1 Maneuver	70	350	-	-	777	-
Mov Cap-2 Maneuver	70	-	-	-	-	-
Stage 1	409	-	-	-	-	-
Stage 2	327	-	-	-	-	-

Approach	WB		NB		SB
HCM Control Delay, s	16.2		0		0.1
HCM LOS	C				

Minor Lane/Major Mvmt	NBT	NBRWBLn1	SBL	SBT
Capacity (veh/h)	-	- 350	777	-
HCM Lane V/C Ratio	-	- 0.084	0.008	-
HCM Control Delay (s)	-	- 16.2	9.7	-
HCM Lane LOS	-	- C	A	-
HCM 95th %tile Q(veh)	-	- 0.3	0	-

Intersection

Int Delay, s/veh 7.4

Movement	WBL	WBR	NBT	NBR	SBL	SBT
Lane Configurations	Y		P			A
Traffic Vol, veh/h	2	26	2	0	6	2
Future Vol, veh/h	2	26	2	0	6	2
Conflicting Peds, #/hr	0	0	0	0	0	0
Sign Control	Stop	Stop	Free	Free	Free	Free
RT Channelized	-	None	-	None	-	None
Storage Length	0	-	-	-	-	-
Veh in Median Storage, #	0	-	0	-	-	0
Grade, %	0	-	0	-	-	0
Peak Hour Factor	75	75	75	75	75	75
Heavy Vehicles, %	0	0	0	0	0	0
Mvmt Flow	3	35	3	0	8	3

Major/Minor	Minor1	Major1	Major2
Conflicting Flow All	22	3	0
Stage 1	3	-	-
Stage 2	19	-	-
Critical Hdwy	6.4	6.2	4.1
Critical Hdwy Stg 1	5.4	-	-
Critical Hdwy Stg 2	5.4	-	-
Follow-up Hdwy	3.5	3.3	2.2
Pot Cap-1 Maneuver	1000	1087	1632
Stage 1	1025	-	-
Stage 2	1009	-	-
Platoon blocked, %			
Mov Cap-1 Maneuver	995	1087	1632
Mov Cap-2 Maneuver	995	-	-
Stage 1	1025	-	-
Stage 2	1004	-	-

Approach	WB	NB	SB
HCM Control Delay, s	8.5	0	5.4
HCM LOS	A		

Minor Lane/Major Mvmt	NBT	NBRWBLn1	SBL	SBT
Capacity (veh/h)	-	- 1080	1632	-
HCM Lane V/C Ratio	-	- 0.035	0.005	-
HCM Control Delay (s)	-	- 8.5	7.2	0
HCM Lane LOS	-	- A	A	A
HCM 95th %tile Q(veh)	-	- 0.1	0	-

Intersection

Int Delay, s/veh 5.5

Movement	EBT	EBR	WBL	WBT	NBL	NBR
Lane Configurations	↔			↔	↔	
Traffic Vol, veh/h	3	4	0	5	21	0
Future Vol, veh/h	3	4	0	5	21	0
Conflicting Peds, #/hr	0	0	0	0	0	1
Sign Control	Free	Free	Free	Free	Stop	Stop
RT Channelized	-	None	-	None	-	None
Storage Length	-	-	-	-	0	-
Veh in Median Storage, #	0	-	-	0	0	-
Grade, %	0	-	-	0	0	-
Peak Hour Factor	70	70	70	70	70	70
Heavy Vehicles, %	0	0	0	0	0	0
Mvmt Flow	4	6	0	7	30	0

Major/Minor	Major1	Major2	Minor1
Conflicting Flow All	0	10	14
Stage 1	-	-	7
Stage 2	-	-	7
Critical Hdwy	-	4.1	6.4
Critical Hdwy Stg 1	-	-	5.4
Critical Hdwy Stg 2	-	-	5.4
Follow-up Hdwy	-	2.2	3.5
Pot Cap-1 Maneuver	-	1623	1010
Stage 1	-	-	1021
Stage 2	-	-	1021
Platoon blocked, %	-	-	-
Mov Cap-1 Maneuver	-	1621	1010
Mov Cap-2 Maneuver	-	-	1010
Stage 1	-	-	1021
Stage 2	-	-	1021

Approach	EB	WB	NB
HCM Control Delay, s	0	0	8.7
HCM LOS			A

Minor Lane/Major Mvmt	NBLn1	EBT	EBR	WBL	WBT
Capacity (veh/h)	1010	-	-	1621	-
HCM Lane V/C Ratio	0.03	-	-	-	-
HCM Control Delay (s)	8.7	-	-	0	-
HCM Lane LOS	A	-	-	A	-
HCM 95th %tile Q(veh)	0.1	-	-	0	-

Intersection

Int Delay, s/veh 0.8

Movement	EBL	EBT	EBR	WBL	WBT	WBR	NBL	NBT	NBR	SBL	SBT	SBR
Lane Configurations		↕			↕		↕	↕		↕	↕	
Traffic Vol, veh/h	4	0	6	3	0	31	5	756	5	12	951	0
Future Vol, veh/h	4	0	6	3	0	31	5	756	5	12	951	0
Conflicting Peds, #/hr	0	0	0	0	0	0	1	0	0	0	0	1
Sign Control	Stop	Stop	Stop	Stop	Stop	Stop	Free	Free	Free	Free	Free	Free
RT Channelized	-	-	None	-	-	None	-	-	None	-	-	None
Storage Length	-	-	-	-	-	-	125	-	-	125	-	-
Veh in Median Storage, #	-	0	-	-	0	-	-	0	-	-	0	-
Grade, %	-	0	-	-	0	-	-	0	-	-	0	-
Peak Hour Factor	90	90	90	90	90	90	90	90	90	90	90	90
Heavy Vehicles, %	0	0	0	0	0	4	0	6	0	0	4	0
Mvmt Flow	4	0	7	3	0	34	6	840	6	13	1057	0

Major/Minor	Minor2			Minor1			Major1			Major2		
Conflicting Flow All	1955	1941	1058	1941	1938	843	1058	0	0	846	0	0
Stage 1	1084	1084	-	854	854	-	-	-	-	-	-	-
Stage 2	871	857	-	1087	1084	-	-	-	-	-	-	-
Critical Hdwy	7.1	6.5	6.2	7.1	6.5	6.24	4.1	-	-	4.1	-	-
Critical Hdwy Stg 1	6.1	5.5	-	6.1	5.5	-	-	-	-	-	-	-
Critical Hdwy Stg 2	6.1	5.5	-	6.1	5.5	-	-	-	-	-	-	-
Follow-up Hdwy	3.5	4	3.3	3.5	4	3.336	2.2	-	-	2.2	-	-
Pot Cap-1 Maneuver	49	66	276	50	66	361	666	-	-	800	-	-
Stage 1	265	296	-	356	378	-	-	-	-	-	-	-
Stage 2	349	377	-	264	296	-	-	-	-	-	-	-
Platoon blocked, %												
Mov Cap-1 Maneuver	43	64	276	48	64	361	666	-	-	800	-	-
Mov Cap-2 Maneuver	43	64	-	48	64	-	-	-	-	-	-	-
Stage 1	262	291	-	353	375	-	-	-	-	-	-	-
Stage 2	313	374	-	253	291	-	-	-	-	-	-	-

Approach	EB	WB	NB	SB
HCM Control Delay, s	52.3	23.8	0.1	0.1
HCM LOS	F	C		

Minor Lane/Major Mvmt	NBL	NBT	NBR	EBLn1WBLn1	SBL	SBT	SBR
Capacity (veh/h)	666	-	-	87	229	800	-
HCM Lane V/C Ratio	0.008	-	-	0.128	0.165	0.017	-
HCM Control Delay (s)	10.5	-	-	52.3	23.8	9.6	-
HCM Lane LOS	B	-	-	F	C	A	-
HCM 95th %tile Q(veh)	0	-	-	0.4	0.6	0.1	-

Intersection												
Int Delay, s/veh	12.4											
Movement	EBL	EBT	EBR	WBL	WBT	WBR	NBL	NBT	NBR	SBL	SBT	SBR
Lane Configurations		↕			↕		↕	↕		↕	↕	
Traffic Vol, veh/h	12	0	13	56	0	18	5	752	25	7	943	7
Future Vol, veh/h	12	0	13	56	0	18	5	752	25	7	943	7
Conflicting Peds, #/hr	0	0	0	0	0	0	1	0	0	0	0	1
Sign Control	Stop	Stop	Stop	Stop	Stop	Stop	Free	Free	Free	Free	Free	Free
RT Channelized	-	-	None	-	-	None	-	-	None	-	-	None
Storage Length	-	-	-	-	-	-	80	-	-	125	-	-
Veh in Median Storage, #	-	0	-	-	0	-	-	0	-	-	0	-
Grade, %	-	0	-	-	0	-	-	0	-	-	0	-
Peak Hour Factor	93	93	93	93	93	93	93	93	93	93	93	93
Heavy Vehicles, %	2	2	2	2	2	2	2	2	2	2	2	2
Mvmt Flow	13	0	14	60	0	19	5	809	27	8	1014	8

Major/Minor	Minor2		Minor1		Major1			Major2				
Conflicting Flow All	1877	1881	1019	1874	1872	823	1023	0	0	836	0	0
Stage 1	1035	1035	-	833	833	-	-	-	-	-	-	-
Stage 2	842	846	-	1041	1039	-	-	-	-	-	-	-
Critical Hdwy	7.12	6.52	6.22	7.12	6.52	6.22	4.12	-	-	4.12	-	-
Critical Hdwy Stg 1	6.12	5.52	-	6.12	5.52	-	-	-	-	-	-	-
Critical Hdwy Stg 2	6.12	5.52	-	6.12	5.52	-	-	-	-	-	-	-
Follow-up Hdwy	3.518	4.018	3.318	3.518	4.018	3.318	2.218	-	-	2.218	-	-
Pot Cap-1 Maneuver	55	71	288	~ 55	72	373	679	-	-	798	-	-
Stage 1	280	309	-	363	384	-	-	-	-	-	-	-
Stage 2	359	378	-	278	308	-	-	-	-	-	-	-
Platoon blocked, %								-	-	-	-	-
Mov Cap-1 Maneuver	51	70	288	~ 52	71	373	678	-	-	798	-	-
Mov Cap-2 Maneuver	51	70	-	~ 52	71	-	-	-	-	-	-	-
Stage 1	278	306	-	360	381	-	-	-	-	-	-	-
Stage 2	338	375	-	262	305	-	-	-	-	-	-	-

Approach	EB		WB		NB		SB	
HCM Control Delay, s	62.1		283.9		0.1		0.1	
HCM LOS	F		F					

Minor Lane/Major Mvmt	NBL	NBT	NBR	EBLn1	WBLn1	SBL	SBT	SBR
Capacity (veh/h)	678	-	-	89	66	798	-	-
HCM Lane V/C Ratio	0.008	-	-	0.302	1.206	0.009	-	-
HCM Control Delay (s)	10.4	-	-	62.1	283.9	9.6	-	-
HCM Lane LOS	B	-	-	F	F	A	-	-
HCM 95th %tile Q(veh)	0	-	-	1.1	6.4	0	-	-

Notes
 ~: Volume exceeds capacity \$: Delay exceeds 300s +: Computation Not Defined *: All major volume in platoon

Intersection

Int Delay, s/veh 1.9

Movement	EBL	EBT	EBR	WBL	WBT	WBR	NBL	NBT	NBR	SBL	SBT	SBR
Lane Configurations		↕			↕			↕			↕	
Traffic Vol, veh/h	7	19	0	2	76	0	4	3	0	3	3	4
Future Vol, veh/h	7	19	0	2	76	0	4	3	0	3	3	4
Conflicting Peds, #/hr	1	0	0	0	0	1	0	0	1	1	0	0
Sign Control	Free	Free	Free	Free	Free	Free	Stop	Stop	Stop	Stop	Stop	Stop
RT Channelized	-	-	None	-	-	None	-	-	None	-	-	None
Storage Length	-	-	-	-	-	-	-	-	-	-	-	-
Veh in Median Storage, #	-	0	-	-	0	-	-	0	-	-	0	-
Grade, %	-	0	-	-	0	-	-	0	-	-	0	-
Peak Hour Factor	74	74	74	74	74	74	74	74	74	74	74	74
Heavy Vehicles, %	0	0	0	0	0	0	33	0	0	0	0	0
Mvmt Flow	9	26	0	3	103	0	5	4	0	4	4	5

Major/Minor	Major1			Major2			Minor1			Minor2		
Conflicting Flow All	104	0	0	26	0	0	158	154	27	157	154	104
Stage 1	-	-	-	-	-	-	45	45	-	109	109	-
Stage 2	-	-	-	-	-	-	113	109	-	48	45	-
Critical Hdwy	4.1	-	-	4.1	-	-	7.43	6.5	6.2	7.1	6.5	6.2
Critical Hdwy Stg 1	-	-	-	-	-	-	6.43	5.5	-	6.1	5.5	-
Critical Hdwy Stg 2	-	-	-	-	-	-	6.43	5.5	-	6.1	5.5	-
Follow-up Hdwy	2.2	-	-	2.2	-	-	3.797	4	3.3	3.5	4	3.3
Pot Cap-1 Maneuver	1500	-	-	1601	-	-	743	741	1054	814	741	956
Stage 1	-	-	-	-	-	-	896	861	-	901	809	-
Stage 2	-	-	-	-	-	-	822	809	-	971	861	-
Platoon blocked, %		-	-		-	-						
Mov Cap-1 Maneuver	1500	-	-	1599	-	-	731	734	1053	804	734	955
Mov Cap-2 Maneuver	-	-	-	-	-	-	731	734	-	804	734	-
Stage 1	-	-	-	-	-	-	891	856	-	895	807	-
Stage 2	-	-	-	-	-	-	812	807	-	960	856	-

Approach	EB		WB		NB		SB
HCM Control Delay, s	2		0.2		10		9.4
HCM LOS					B		A

Minor Lane/Major Mvmt	NBLn1	EBL	EBT	EBR	WBL	WBT	WBR	SBLn1
Capacity (veh/h)	732	1500	-	-	1599	-	-	833
HCM Lane V/C Ratio	0.013	0.006	-	-	0.002	-	-	0.016
HCM Control Delay (s)	10	7.4	0	-	7.3	0	-	9.4
HCM Lane LOS	B	A	A	-	A	A	-	A
HCM 95th %tile Q(veh)	0	0	-	-	0	-	-	0

Intersection

Int Delay, s/veh 7.8

Movement	EBL	EBT	EBR	WBL	WBT	WBR	NBL	NBT	NBR	SBL	SBT	SBR
Lane Configurations		↕			↕			↕			↕	
Traffic Vol, veh/h	0	17	0	2	76	11	3	20	0	2	5	0
Future Vol, veh/h	0	17	0	2	76	11	3	20	0	2	5	0
Conflicting Peds, #/hr	1	0	0	0	0	1	0	0	0	0	0	0
Sign Control	Stop	Stop	Stop	Stop	Stop	Stop	Free	Free	Free	Free	Free	Free
RT Channelized	-	-	None	-	-	None	-	-	None	-	-	None
Storage Length	-	-	-	-	-	-	-	-	-	-	-	-
Veh in Median Storage, #	-	0	-	-	0	-	-	0	-	-	0	-
Grade, %	-	0	-	-	0	-	-	0	-	-	0	-
Peak Hour Factor	83	83	83	83	83	83	83	83	83	83	83	83
Heavy Vehicles, %	0	0	0	0	0	0	0	6	0	0	0	0
Mvmt Flow	0	20	0	2	92	13	4	24	0	2	6	0

Major/Minor	Minor2			Minor1			Major1			Major2		
Conflicting Flow All	96	42	6	52	42	25	6	0	0	24	0	0
Stage 1	11	11	-	31	31	-	-	-	-	-	-	-
Stage 2	85	31	-	21	11	-	-	-	-	-	-	-
Critical Hdwy	7.1	6.5	6.2	7.1	6.5	6.2	4.1	-	-	4.1	-	-
Critical Hdwy Stg 1	6.1	5.5	-	6.1	5.5	-	-	-	-	-	-	-
Critical Hdwy Stg 2	6.1	5.5	-	6.1	5.5	-	-	-	-	-	-	-
Follow-up Hdwy	3.5	4	3.3	3.5	4	3.3	2.2	-	-	2.2	-	-
Pot Cap-1 Maneuver	891	854	1083	952	854	1057	1628	-	-	1604	-	-
Stage 1	1015	890	-	991	873	-	-	-	-	-	-	-
Stage 2	928	873	-	1003	890	-	-	-	-	-	-	-
Platoon blocked, %												
Mov Cap-1 Maneuver	805	851	1083	932	851	1056	1628	-	-	1602	-	-
Mov Cap-2 Maneuver	805	851	-	932	851	-	-	-	-	-	-	-
Stage 1	1013	889	-	989	871	-	-	-	-	-	-	-
Stage 2	818	871	-	979	889	-	-	-	-	-	-	-

Approach	EB	WB	NB	SB
HCM Control Delay, s	9.3	9.7	0.9	2.1
HCM LOS	A	A		

Minor Lane/Major Mvmt	NBL	NBT	NBR	EBLn1WBLn1	SBL	SBT	SBR
Capacity (veh/h)	1628	-	-	851	874	1602	-
HCM Lane V/C Ratio	0.002	-	-	0.024	0.123	0.002	-
HCM Control Delay (s)	7.2	0	-	9.3	9.7	7.3	0
HCM Lane LOS	A	A	-	A	A	A	A
HCM 95th %tile Q(veh)	0	-	-	0.1	0.4	0	-

Intersection	
Intersection Delay, s/veh	7.3
Intersection LOS	A

Movement	EBU	EBL	EBT	EBR	WBU	WBL	WBT	WBR	NBU	NBL	NBT	NBR
Lane Configurations			↕				↕				↕	
Traffic Vol, veh/h	0	0	20	2	0	6	73	2	0	2	2	3
Future Vol, veh/h	0	0	20	2	0	6	73	2	0	2	2	3
Peak Hour Factor	0.92	0.90	0.90	0.90	0.92	0.90	0.90	0.90	0.92	0.90	0.90	0.90
Heavy Vehicles, %	2	0	6	0	2	0	0	0	2	0	0	0
Mvmt Flow	0	0	22	2	0	7	81	2	0	2	2	3
Number of Lanes	0	0	1	0	0	0	1	0	0	0	1	0

Approach	EB	WB	NB
Opposing Approach	WB	EB	SB
Opposing Lanes	1	1	1
Conflicting Approach Left	SB	NB	EB
Conflicting Lanes Left	1	1	1
Conflicting Approach Right	NB	SB	WB
Conflicting Lanes Right	1	1	1
HCM Control Delay	7.2	7.4	7
HCM LOS	A	A	A

Lane	NBLn1	EBLn1	WBLn1	SBLn1
Vol Left, %	29%	0%	7%	0%
Vol Thru, %	29%	91%	90%	0%
Vol Right, %	43%	9%	2%	100%
Sign Control	Stop	Stop	Stop	Stop
Traffic Vol by Lane	7	22	81	7
LT Vol	2	0	6	0
Through Vol	2	20	73	0
RT Vol	3	2	2	7
Lane Flow Rate	8	24	90	8
Geometry Grp	1	1	1	1
Degree of Util (X)	0.008	0.027	0.099	0.008
Departure Headway (Hd)	3.904	4.042	3.946	3.504
Convergence, Y/N	Yes	Yes	Yes	Yes
Cap	911	887	912	1014
Service Time	1.952	2.062	1.954	1.551
HCM Lane V/C Ratio	0.009	0.027	0.099	0.008
HCM Control Delay	7	7.2	7.4	6.6
HCM Lane LOS	A	A	A	A
HCM 95th-tile Q	0	0.1	0.3	0

Intersection

Intersection Delay, s/veh

Intersection LOS

Movement	SBU	SBL	SBT	SBR
Lane Configurations			↕	
Traffic Vol, veh/h	0	0	0	7
Future Vol, veh/h	0	0	0	7
Peak Hour Factor	0.92	0.90	0.90	0.90
Heavy Vehicles, %	2	0	0	0
Mvmt Flow	0	0	0	8
Number of Lanes	0	0	1	0

Approach SB

Opposing Approach	NB
Opposing Lanes	1
Conflicting Approach Left	WB
Conflicting Lanes Left	1
Conflicting Approach Right	EB
Conflicting Lanes Right	1
HCM Control Delay	6.6
HCM LOS	A

Intersection

Int Delay, s/veh 0.8

Movement	WBL	WBR	NBT	NBR	SBL	SBT
Lane Configurations	↘↙		↑	↗		↖
Traffic Vol, veh/h	13	6	1037	21	6	1078
Future Vol, veh/h	13	6	1037	21	6	1078
Conflicting Peds, #/hr	0	0	0	1	1	0
Sign Control	Stop	Stop	Free	Free	Free	Free
RT Channelized	-	None	-	None	-	None
Storage Length	0	-	-	125	-	-
Veh in Median Storage, #	0	-	0	-	-	0
Grade, %	0	-	0	-	-	0
Peak Hour Factor	95	95	95	95	95	95
Heavy Vehicles, %	0	0	2	0	0	2
Mvmt Flow	14	6	1092	22	6	1135

Major/Minor	Minor1		Major1		Major2	
Conflicting Flow All	2240	1093	0	0	1093	0
Stage 1	1093	-	-	-	-	-
Stage 2	1147	-	-	-	-	-
Critical Hdwy	6.4	6.2	-	-	4.1	-
Critical Hdwy Stg 1	5.4	-	-	-	-	-
Critical Hdwy Stg 2	5.4	-	-	-	-	-
Follow-up Hdwy	3.5	3.3	-	-	2.2	-
Pot Cap-1 Maneuver	47	263	-	-	646	-
Stage 1	324	-	-	-	-	-
Stage 2	305	-	-	-	-	-
Platoon blocked, %			-	-		
Mov Cap-1 Maneuver	46	263	-	-	646	-
Mov Cap-2 Maneuver	46	-	-	-	-	-
Stage 1	324	-	-	-	-	-
Stage 2	297	-	-	-	-	-

Approach	WB		NB		SB
HCM Control Delay, s	88.6		0		0.1
HCM LOS	F				

Minor Lane/Major Mvmt	NBT	NBRWBLn1	SBL	SBT
Capacity (veh/h)	-	- 62	646	-
HCM Lane V/C Ratio	-	- 0.323	0.01	-
HCM Control Delay (s)	-	- 88.6	10.6	0
HCM Lane LOS	-	- F	B	A
HCM 95th %tile Q(veh)	-	- 1.2	0	-

Intersection

Int Delay, s/veh 0.7

Movement	EBL	EBT	EBR	WBL	WBT	WBR	NBL	NBT	NBR	SBL	SBT	SBR
Lane Configurations		↔			↔		↑	↑		↑	↑	
Traffic Vol, veh/h	6	0	5	2	0	3	0	1046	0	2	1084	5
Future Vol, veh/h	6	0	5	2	0	3	0	1046	0	2	1084	5
Conflicting Peds, #/hr	5	0	0	0	0	5	0	0	4	4	0	0
Sign Control	Stop	Stop	Stop	Stop	Stop	Stop	Free	Free	Free	Free	Free	Free
RT Channelized	-	-	None	-	-	None	-	-	None	-	-	None
Storage Length	-	-	-	-	-	-	65	-	-	50	-	-
Veh in Median Storage, #	-	0	-	-	0	-	-	0	-	-	0	-
Grade, %	-	0	-	-	0	-	-	0	-	-	0	-
Peak Hour Factor	94	94	94	94	94	94	94	94	94	94	94	94
Heavy Vehicles, %	0	0	0	0	0	0	0	2	0	0	1	0
Mvmt Flow	6	0	5	2	0	3	0	1113	0	2	1153	5

Major/Minor	Minor2			Minor1			Major1			Major2		
Conflicting Flow All	2279	2277	1156	2280	2280	1122	1159	0	0	1117	0	0
Stage 1	1160	1160	-	1117	1117	-	-	-	-	-	-	-
Stage 2	1119	1117	-	1163	1163	-	-	-	-	-	-	-
Critical Hdwy	7.1	6.5	6.2	7.1	6.5	6.2	4.1	-	-	4.1	-	-
Critical Hdwy Stg 1	6.1	5.5	-	6.1	5.5	-	-	-	-	-	-	-
Critical Hdwy Stg 2	6.1	5.5	-	6.1	5.5	-	-	-	-	-	-	-
Follow-up Hdwy	3.5	4	3.3	3.5	4	3.3	2.2	-	-	2.2	-	-
Pot Cap-1 Maneuver	29	41	242	29	40	253	610	-	-	633	-	-
Stage 1	240	272	-	254	285	-	-	-	-	-	-	-
Stage 2	253	285	-	239	271	-	-	-	-	-	-	-
Platoon blocked, %												
Mov Cap-1 Maneuver	28	41	242	28	40	251	610	-	-	630	-	-
Mov Cap-2 Maneuver	28	41	-	28	40	-	-	-	-	-	-	-
Stage 1	240	271	-	253	284	-	-	-	-	-	-	-
Stage 2	249	284	-	233	270	-	-	-	-	-	-	-

Approach	EB	WB	NB	SB
HCM Control Delay, s	105.3	70.8	0	0
HCM LOS	F	F		

Minor Lane/Major Mvmt	NBL	NBT	NBR	EBLn1	WBLn1	SBL	SBT	SBR
Capacity (veh/h)	610	-	-	47	60	630	-	-
HCM Lane V/C Ratio	-	-	-	0.249	0.089	0.003	-	-
HCM Control Delay (s)	0	-	-	105.3	70.8	10.7	-	-
HCM Lane LOS	A	-	-	F	F	B	-	-
HCM 95th %tile Q(veh)	0	-	-	0.8	0.3	0	-	-

Intersection

Int Delay, s/veh 0.2

Movement	WBL	WBR	NBT	NBR	SBL	SBT
Lane Configurations	Y		P		T	T
Traffic Vol, veh/h	0	6	1035	0	21	1059
Future Vol, veh/h	0	6	1035	0	21	1059
Conflicting Peds, #/hr	0	0	0	2	2	0
Sign Control	Stop	Stop	Free	Free	Free	Free
RT Channelized	-	None	-	None	-	None
Storage Length	0	-	-	-	65	-
Veh in Median Storage, #	0	-	0	-	-	0
Grade, %	0	-	0	-	-	0
Peak Hour Factor	96	96	96	96	96	96
Heavy Vehicles, %	0	0	2	0	0	2
Mvmt Flow	0	6	1078	0	22	1103

Major/Minor	Minor1		Major1		Major2	
Conflicting Flow All	2227	1080	0	0	1080	0
Stage 1	1080	-	-	-	-	-
Stage 2	1147	-	-	-	-	-
Critical Hdwy	6.4	6.2	-	-	4.1	-
Critical Hdwy Stg 1	5.4	-	-	-	-	-
Critical Hdwy Stg 2	5.4	-	-	-	-	-
Follow-up Hdwy	3.5	3.3	-	-	2.2	-
Pot Cap-1 Maneuver	48	268	-	-	653	-
Stage 1	329	-	-	-	-	-
Stage 2	305	-	-	-	-	-
Platoon blocked, %			-	-		
Mov Cap-1 Maneuver	46	267	-	-	653	-
Mov Cap-2 Maneuver	46	-	-	-	-	-
Stage 1	328	-	-	-	-	-
Stage 2	295	-	-	-	-	-

Approach	WB		NB		SB
HCM Control Delay, s	18.8		0		0.2
HCM LOS	C				

Minor Lane/Major Mvmt	NBT	NBRWBLn1	SBL	SBT
Capacity (veh/h)	-	- 267	653	-
HCM Lane V/C Ratio	-	- 0.023	0.033	-
HCM Control Delay (s)	-	- 18.8	10.7	-
HCM Lane LOS	-	- C	B	-
HCM 95th %tile Q(veh)	-	- 0.1	0.1	-

Intersection

Int Delay, s/veh 6.2

Movement	WBL	WBR	NBT	NBR	SBL	SBT
Lane Configurations	Y		P			A
Traffic Vol, veh/h	5	7	2	7	22	0
Future Vol, veh/h	5	7	2	7	22	0
Conflicting Peds, #/hr	1	0	0	5	5	0
Sign Control	Stop	Stop	Free	Free	Free	Free
RT Channelized	-	None	-	None	-	None
Storage Length	0	-	-	-	-	-
Veh in Median Storage, #	0	-	0	-	-	0
Grade, %	0	-	0	-	-	0
Peak Hour Factor	75	75	75	75	75	75
Heavy Vehicles, %	0	17	0	0	0	0
Mvmt Flow	7	9	3	9	29	0

Major/Minor	Minor1		Major1		Major2	
Conflicting Flow All	72	12	0	0	17	0
Stage 1	12	-	-	-	-	-
Stage 2	60	-	-	-	-	-
Critical Hdwy	6.4	6.37	-	-	4.1	-
Critical Hdwy Stg 1	5.4	-	-	-	-	-
Critical Hdwy Stg 2	5.4	-	-	-	-	-
Follow-up Hdwy	3.5	3.453	-	-	2.2	-
Pot Cap-1 Maneuver	937	1027	-	-	1613	-
Stage 1	1016	-	-	-	-	-
Stage 2	968	-	-	-	-	-
Platoon blocked, %			-	-		
Mov Cap-1 Maneuver	915	1022	-	-	1613	-
Mov Cap-2 Maneuver	915	-	-	-	-	-
Stage 1	1011	-	-	-	-	-
Stage 2	950	-	-	-	-	-

Approach	WB		NB		SB
HCM Control Delay, s	8.8		0		7.3
HCM LOS	A				

Minor Lane/Major Mvmt	NBT	NBRWBLn1	SBL	SBT
Capacity (veh/h)	-	- 975	1613	-
HCM Lane V/C Ratio	-	- 0.016	0.018	-
HCM Control Delay (s)	-	- 8.8	7.3	0
HCM Lane LOS	-	- A	A	A
HCM 95th %tile Q(veh)	-	- 0.1	0.1	-

Intersection

Int Delay, s/veh 2.1

Movement	EBT	EBR	WBL	WBT	NBL	NBR
Lane Configurations	↔		↔		↔	
Traffic Vol, veh/h	10	19	2	5	9	0
Future Vol, veh/h	10	19	2	5	9	0
Conflicting Peds, #/hr	0	3	3	0	1	0
Sign Control	Free	Free	Free	Free	Stop	Stop
RT Channelized	-	None	-	None	-	None
Storage Length	-	-	-	-	0	-
Veh in Median Storage, #	0	-	-	0	0	-
Grade, %	0	-	-	0	0	-
Peak Hour Factor	69	69	69	69	69	69
Heavy Vehicles, %	0	0	0	0	29	0
Mvmt Flow	14	28	3	7	13	0

Major/Minor	Major1	Major2	Minor1
Conflicting Flow All	0	45	45
Stage 1	-	-	31
Stage 2	-	-	14
Critical Hdwy	-	4.1	6.69
Critical Hdwy Stg 1	-	-	5.69
Critical Hdwy Stg 2	-	-	5.69
Follow-up Hdwy	-	2.2	3.761
Pot Cap-1 Maneuver	-	1576	901
Stage 1	-	-	926
Stage 2	-	-	943
Platoon blocked, %	-	-	-
Mov Cap-1 Maneuver	-	1576	896
Mov Cap-2 Maneuver	-	-	896
Stage 1	-	-	923
Stage 2	-	-	940

Approach	EB	WB	NB
HCM Control Delay, s	0	2.1	9.1
HCM LOS			A

Minor Lane/Major Mvmt	NBLn1	EBT	EBR	WBL	WBT
Capacity (veh/h)	896	-	-	1576	-
HCM Lane V/C Ratio	0.015	-	-	0.002	-
HCM Control Delay (s)	9.1	-	-	7.3	0
HCM Lane LOS	A	-	-	A	A
HCM 95th %tile Q(veh)	0	-	-	0	-

Intersection

Int Delay, s/veh 2.2

Movement	EBL	EBT	EBR	WBL	WBT	WBR	NBL	NBT	NBR	SBL	SBT	SBR
Lane Configurations		↔			↔		↑	↑		↑	↑	
Traffic Vol, veh/h	9	0	9	9	0	20	12	1001	9	33	990	6
Future Vol, veh/h	9	0	9	9	0	20	12	1001	9	33	990	6
Conflicting Peds, #/hr	0	0	0	0	0	0	0	0	2	2	0	0
Sign Control	Stop	Stop	Stop	Stop	Stop	Stop	Free	Free	Free	Free	Free	Free
RT Channelized	-	-	None	-	-	None	-	-	None	-	-	None
Storage Length	-	-	-	-	-	-	125	-	-	125	-	-
Veh in Median Storage, #	-	0	-	-	0	-	-	0	-	-	0	-
Grade, %	-	0	-	-	0	-	-	0	-	-	0	-
Peak Hour Factor	96	96	96	96	96	96	96	96	96	96	96	96
Heavy Vehicles, %	0	0	0	0	0	0	0	2	14	7	2	0
Mvmt Flow	9	0	9	9	0	21	13	1043	9	34	1031	6

Major/Minor	Minor2			Minor1			Major1			Major2		
Conflicting Flow All	2186	2182	1034	2182	2180	1049	1038	0	0	1054	0	0
Stage 1	1103	1103	-	1074	1074	-	-	-	-	-	-	-
Stage 2	1083	1079	-	1108	1106	-	-	-	-	-	-	-
Critical Hdwy	7.1	6.5	6.2	7.1	6.5	6.2	4.1	-	-	4.17	-	-
Critical Hdwy Stg 1	6.1	5.5	-	6.1	5.5	-	-	-	-	-	-	-
Critical Hdwy Stg 2	6.1	5.5	-	6.1	5.5	-	-	-	-	-	-	-
Follow-up Hdwy	3.5	4	3.3	3.5	4	3.3	2.2	-	-	2.263	-	-
Pot Cap-1 Maneuver	33	47	285	34	47	279	678	-	-	642	-	-
Stage 1	259	290	-	269	299	-	-	-	-	-	-	-
Stage 2	265	297	-	257	289	-	-	-	-	-	-	-
Platoon blocked, %												
Mov Cap-1 Maneuver	29	44	285	31	44	278	678	-	-	642	-	-
Mov Cap-2 Maneuver	29	44	-	31	44	-	-	-	-	-	-	-
Stage 1	254	275	-	263	293	-	-	-	-	-	-	-
Stage 2	240	291	-	235	274	-	-	-	-	-	-	-

Approach	EB	WB	NB	SB
HCM Control Delay, s	106.3	75.1	0.1	0.4
HCM LOS	F	F		

Minor Lane/Major Mvmt	NBL	NBT	NBR	EBLn1	WBLn1	SBL	SBT	SBR
Capacity (veh/h)	678	-	-	53	80	642	-	-
HCM Lane V/C Ratio	0.018	-	-	0.354	0.378	0.054	-	-
HCM Control Delay (s)	10.4	-	-	106.3	75.1	10.9	-	-
HCM Lane LOS	B	-	-	F	F	B	-	-
HCM 95th %tile Q(veh)	0.1	-	-	1.3	1.5	0.2	-	-

Intersection												
Int Delay, s/veh	13											
Movement	EBL	EBT	EBR	WBL	WBT	WBR	NBL	NBT	NBR	SBL	SBT	SBR
Lane Configurations		↕			↕		↕	↕		↕	↕	
Traffic Vol, veh/h	4	0	4	37	0	16	10	1039	49	20	972	12
Future Vol, veh/h	4	0	4	37	0	16	10	1039	49	20	972	12
Conflicting Peds, #/hr	0	0	0	0	0	0	1	0	0	0	0	1
Sign Control	Stop	Stop	Stop	Stop	Stop	Stop	Free	Free	Free	Free	Free	Free
RT Channelized	-	-	None	-	-	None	-	-	None	-	-	None
Storage Length	-	-	-	-	-	-	80	-	-	125	-	-
Veh in Median Storage, #	-	0	-	-	0	-	-	0	-	-	0	-
Grade, %	-	0	-	-	0	-	-	0	-	-	0	-
Peak Hour Factor	93	93	93	93	93	93	93	93	93	93	93	93
Heavy Vehicles, %	2	2	2	2	2	2	2	2	2	2	2	2
Mvmt Flow	4	0	4	40	0	17	11	1117	53	22	1045	13

Major/Minor	Minor2		Minor1		Major1		Major2					
Conflicting Flow All	2271	2289	1053	2264	2269	1144	1059	0	0	1170	0	0
Stage 1	1097	1097	-	1166	1166	-	-	-	-	-	-	-
Stage 2	1174	1192	-	1098	1103	-	-	-	-	-	-	-
Critical Hdwy	7.12	6.52	6.22	7.12	6.52	6.22	4.12	-	-	4.12	-	-
Critical Hdwy Stg 1	6.12	5.52	-	6.12	5.52	-	-	-	-	-	-	-
Critical Hdwy Stg 2	6.12	5.52	-	6.12	5.52	-	-	-	-	-	-	-
Follow-up Hdwy	3.518	4.018	3.318	3.518	4.018	3.318	2.218	-	-	2.218	-	-
Pot Cap-1 Maneuver	29	39	275	~29	40	243	658	-	-	597	-	-
Stage 1	258	289	-	236	268	-	-	-	-	-	-	-
Stage 2	234	261	-	258	287	-	-	-	-	-	-	-
Platoon blocked, %								-	-	-	-	-
Mov Cap-1 Maneuver	26	37	275	~27	38	243	657	-	-	597	-	-
Mov Cap-2 Maneuver	26	37	-	~27	38	-	-	-	-	-	-	-
Stage 1	253	278	-	232	263	-	-	-	-	-	-	-
Stage 2	214	257	-	245	276	-	-	-	-	-	-	-

Approach	EB	WB	NB	SB
HCM Control Delay, s	95.7	\$ 510.6	0.1	0.2
HCM LOS	F	F		

Minor Lane/Major Mvmt	NBL	NBT	NBR	EBLn1	WBLn1	SBL	SBT	SBR
Capacity (veh/h)	657	-	-	48	37	597	-	-
HCM Lane V/C Ratio	0.016	-	-	0.179	1.54	0.036	-	-
HCM Control Delay (s)	10.6	-	-	95.7	\$ 510.6	11.3	-	-
HCM Lane LOS	B	-	-	F	F	B	-	-
HCM 95th %tile Q(veh)	0.1	-	-	0.6	6	0.1	-	-

Notes
 ~: Volume exceeds capacity \$: Delay exceeds 300s +: Computation Not Defined *: All major volume in platoon

Intersection

Int Delay, s/veh 4

Movement	EBL	EBT	EBR	WBL	WBT	WBR	NBL	NBT	NBR	SBL	SBT	SBR
Lane Configurations		↕			↕			↕			↕	
Traffic Vol, veh/h	16	41	3	0	40	5	11	9	7	4	10	14
Future Vol, veh/h	16	41	3	0	40	5	11	9	7	4	10	14
Conflicting Peds, #/hr	2	0	1	1	0	2	0	0	0	0	0	0
Sign Control	Free	Free	Free	Free	Free	Free	Stop	Stop	Stop	Stop	Stop	Stop
RT Channelized	-	-	None	-	-	None	-	-	None	-	-	None
Storage Length	-	-	-	-	-	-	-	-	-	-	-	-
Veh in Median Storage, #	-	0	-	-	0	-	-	0	-	-	0	-
Grade, %	-	0	-	-	0	-	-	0	-	-	0	-
Peak Hour Factor	79	79	79	79	79	79	79	79	79	79	79	79
Heavy Vehicles, %	0	3	0	0	0	0	0	0	0	33	0	0
Mvmt Flow	20	52	4	0	51	6	14	11	9	5	13	18

Major/Minor	Major1			Major2			Minor1			Minor2		
Conflicting Flow All	59	0	0	57	0	0	164	154	55	160	153	56
Stage 1	-	-	-	-	-	-	95	95	-	56	56	-
Stage 2	-	-	-	-	-	-	69	59	-	104	97	-
Critical Hdwy	4.1	-	-	4.1	-	-	7.1	6.5	6.2	7.43	6.5	6.2
Critical Hdwy Stg 1	-	-	-	-	-	-	6.1	5.5	-	6.43	5.5	-
Critical Hdwy Stg 2	-	-	-	-	-	-	6.1	5.5	-	6.43	5.5	-
Follow-up Hdwy	2.2	-	-	2.2	-	-	3.5	4	3.3	3.797	4	3.3
Pot Cap-1 Maneuver	1558	-	-	1560	-	-	805	741	1018	741	742	1016
Stage 1	-	-	-	-	-	-	917	820	-	883	852	-
Stage 2	-	-	-	-	-	-	946	850	-	831	819	-
Platoon blocked, %	-	-	-	-	-	-	-	-	-	-	-	-
Mov Cap-1 Maneuver	1558	-	-	1560	-	-	772	729	1017	717	730	1014
Mov Cap-2 Maneuver	-	-	-	-	-	-	772	729	-	717	730	-
Stage 1	-	-	-	-	-	-	904	809	-	870	850	-
Stage 2	-	-	-	-	-	-	916	848	-	802	808	-

Approach	EB	WB	NB	SB
HCM Control Delay, s	2	0	9.7	9.4
HCM LOS			A	A

Minor Lane/Major Mvmt	NBLn1	EBL	EBT	EBR	WBL	WBT	WBR	SBLn1
Capacity (veh/h)	807	1558	-	-	1560	-	-	846
HCM Lane V/C Ratio	0.042	0.013	-	-	-	-	-	0.042
HCM Control Delay (s)	9.7	7.3	0	-	0	-	-	9.4
HCM Lane LOS	A	A	A	-	A	-	-	A
HCM 95th %tile Q(veh)	0.1	0	-	-	0	-	-	0.1

Intersection												
Int Delay, s/veh	7.6											
Movement	EBL	EBT	EBR	WBL	WBT	WBR	NBL	NBT	NBR	SBL	SBT	SBR
Lane Configurations		↕			↕			↕			↕	
Traffic Vol, veh/h	0	46	4	11	39	3	5	7	6	18	14	3
Future Vol, veh/h	0	46	4	11	39	3	5	7	6	18	14	3
Conflicting Peds, #/hr	3	0	0	0	0	3	3	0	2	2	0	3
Sign Control	Stop	Stop	Stop	Stop	Stop	Stop	Free	Free	Free	Free	Free	Free
RT Channelized	-	-	None	-	-	None	-	-	None	-	-	None
Storage Length	-	-	-	-	-	-	-	-	-	-	-	-
Veh in Median Storage, #	-	0	-	-	0	-	-	0	-	-	0	-
Grade, %	-	0	-	-	0	-	-	0	-	-	0	-
Peak Hour Factor	86	86	86	86	86	86	86	86	86	86	86	86
Heavy Vehicles, %	0	5	0	22	0	0	0	0	0	0	8	0
Mvmt Flow	0	53	5	13	45	3	6	8	7	21	16	3
Major/Minor	Minor2			Minor1			Major1			Major2		
Conflicting Flow All	114	92	21	114	90	17	23	0	0	17	0	0
Stage 1	63	63	-	25	25	-	-	-	-	-	-	-
Stage 2	51	29	-	89	65	-	-	-	-	-	-	-
Critical Hdwy	7.1	6.55	6.2	7.32	6.5	6.2	4.1	-	-	4.1	-	-
Critical Hdwy Stg 1	6.1	5.55	-	6.32	5.5	-	-	-	-	-	-	-
Critical Hdwy Stg 2	6.1	5.55	-	6.32	5.5	-	-	-	-	-	-	-
Follow-up Hdwy	3.5	4.045	3.3	3.698	4	3.3	2.2	-	-	2.2	-	-
Pot Cap-1 Maneuver	868	792	1062	818	804	1068	1605	-	-	1613	-	-
Stage 1	953	837	-	944	878	-	-	-	-	-	-	-
Stage 2	967	865	-	871	845	-	-	-	-	-	-	-
Platoon blocked, %												
Mov Cap-1 Maneuver	812	775	1059	760	787	1063	1605	-	-	1608	-	-
Mov Cap-2 Maneuver	812	775	-	760	787	-	-	-	-	-	-	-
Stage 1	946	824	-	938	873	-	-	-	-	-	-	-
Stage 2	908	860	-	800	832	-	-	-	-	-	-	-
Approach	EB			WB			NB			SB		
HCM Control Delay, s	9.9			9.9			2			3.7		
HCM LOS	A			A								
Minor Lane/Major Mvmt	NBL	NBT	NBR	EBLn1	WBLn1	SBL	SBT	SBR				
Capacity (veh/h)	1605	-	-	792	793	1608	-	-				
HCM Lane V/C Ratio	0.004	-	-	0.073	0.078	0.013	-	-				
HCM Control Delay (s)	7.3	0	-	9.9	9.9	7.3	0	-				
HCM Lane LOS	A	A	-	A	A	A	A	-				
HCM 95th %tile Q(veh)	0	-	-	0.2	0.3	0	-	-				

Intersection	
Intersection Delay, s/veh	7.4
Intersection LOS	A

Movement	EBU	EBL	EBT	EBR	WBU	WBL	WBT	WBR	NBU	NBL	NBT	NBR
Lane Configurations			↕				↕				↕	
Traffic Vol, veh/h	0	3	62	7	0	2	37	0	0	6	3	4
Future Vol, veh/h	0	3	62	7	0	2	37	0	0	6	3	4
Peak Hour Factor	0.92	0.75	0.75	0.75	0.92	0.75	0.75	0.75	0.92	0.75	0.75	0.75
Heavy Vehicles, %	2	0	4	0	2	0	0	0	2	40	0	0
Mvmt Flow	0	4	83	9	0	3	49	0	0	8	4	5
Number of Lanes	0	0	1	0	0	0	1	0	0	0	1	0

Approach	EB	WB	NB
Opposing Approach	WB	EB	SB
Opposing Lanes	1	1	1
Conflicting Approach Left	SB	NB	EB
Conflicting Lanes Left	1	1	1
Conflicting Approach Right	NB	SB	WB
Conflicting Lanes Right	1	1	1
HCM Control Delay	7.4	7.3	7.9
HCM LOS	A	A	A

Lane	NBLn1	EBLn1	WBLn1	SBLn1
Vol Left, %	46%	4%	5%	0%
Vol Thru, %	23%	86%	95%	0%
Vol Right, %	31%	10%	0%	100%
Sign Control	Stop	Stop	Stop	Stop
Traffic Vol by Lane	13	72	39	5
LT Vol	6	3	2	0
Through Vol	3	62	37	0
RT Vol	4	7	0	5
Lane Flow Rate	17	96	52	7
Geometry Grp	1	1	1	1
Degree of Util (X)	0.023	0.105	0.058	0.007
Departure Headway (Hd)	4.748	3.93	4.023	3.566
Convergence, Y/N	Yes	Yes	Yes	Yes
Cap	749	911	888	991
Service Time	2.811	1.958	2.058	1.634
HCM Lane V/C Ratio	0.023	0.105	0.059	0.007
HCM Control Delay	7.9	7.4	7.3	6.7
HCM Lane LOS	A	A	A	A
HCM 95th-tile Q	0.1	0.4	0.2	0

Intersection

Intersection Delay, s/veh

Intersection LOS

Movement	SBU	SBL	SBT	SBR
Lane Configurations			↕	
Traffic Vol, veh/h	0	0	0	5
Future Vol, veh/h	0	0	0	5
Peak Hour Factor	0.92	0.75	0.75	0.75
Heavy Vehicles, %	2	0	0	0
Mvmt Flow	0	0	0	7
Number of Lanes	0	0	1	0

Approach SB

Opposing Approach	NB
Opposing Lanes	1
Conflicting Approach Left	WB
Conflicting Lanes Left	1
Conflicting Approach Right	EB
Conflicting Lanes Right	1
HCM Control Delay	6.7
HCM LOS	A

Intersection

Int Delay, s/veh 0.4

Movement	WBL	WBR	NBT	NBR	SBL	SBT
Lane Configurations	↘↙		↑	↗		↖
Traffic Vol, veh/h	9	4	1008	11	5	957
Future Vol, veh/h	9	4	1008	11	5	957
Conflicting Peds, #/hr	0	0	0	1	1	0
Sign Control	Stop	Stop	Free	Free	Free	Free
RT Channelized	-	None	-	None	-	None
Storage Length	0	-	-	125	-	-
Veh in Median Storage, #	0	-	0	-	-	0
Grade, %	0	-	0	-	-	0
Peak Hour Factor	96	96	96	96	96	96
Heavy Vehicles, %	0	0	2	0	0	1
Mvmt Flow	9	4	1050	11	5	997

Major/Minor	Minor1		Major1		Major2	
Conflicting Flow All	2058	1051	0	0	1051	0
Stage 1	1051	-	-	-	-	-
Stage 2	1007	-	-	-	-	-
Critical Hdwy	6.4	6.2	-	-	4.1	-
Critical Hdwy Stg 1	5.4	-	-	-	-	-
Critical Hdwy Stg 2	5.4	-	-	-	-	-
Follow-up Hdwy	3.5	3.3	-	-	2.2	-
Pot Cap-1 Maneuver	61	278	-	-	670	-
Stage 1	339	-	-	-	-	-
Stage 2	356	-	-	-	-	-
Platoon blocked, %			-	-		
Mov Cap-1 Maneuver	60	278	-	-	670	-
Mov Cap-2 Maneuver	60	-	-	-	-	-
Stage 1	339	-	-	-	-	-
Stage 2	350	-	-	-	-	-

Approach	WB		NB		SB
HCM Control Delay, s	59.8		0		0.1
HCM LOS	F				

Minor Lane/Major Mvmt	NBT	NBRWBLn1	SBL	SBT
Capacity (veh/h)	-	-	79	670
HCM Lane V/C Ratio	-	-	0.171	0.008
HCM Control Delay (s)	-	-	59.8	10.4
HCM Lane LOS	-	-	F	B
HCM 95th %tile Q(veh)	-	-	0.6	0

Intersection

Int Delay, s/veh 0.1

Movement	EBL	EBT	EBR	WBL	WBT	WBR	NBL	NBT	NBR	SBL	SBT	SBR
Lane Configurations		↔			↔		↑	↑		↑	↑	
Traffic Vol, veh/h	0	0	0	2	0	2	3	1005	0	2	966	5
Future Vol, veh/h	0	0	0	2	0	2	3	1005	0	2	966	5
Conflicting Peds, #/hr	0	0	1	1	0	0	0	0	3	3	0	0
Sign Control	Stop	Stop	Stop	Stop	Stop	Stop	Free	Free	Free	Free	Free	Free
RT Channelized	-	-	None	-	-	None	-	-	None	-	-	None
Storage Length	-	-	-	-	-	-	65	-	-	50	-	-
Veh in Median Storage, #	-	0	-	-	0	-	-	0	-	-	0	-
Grade, %	-	0	-	-	0	-	-	0	-	-	0	-
Peak Hour Factor	96	96	96	96	96	96	96	96	96	96	96	96
Heavy Vehicles, %	0	0	0	0	0	0	0	3	0	0	2	0
Mvmt Flow	0	0	0	2	0	2	3	1047	0	2	1006	5

Major/Minor	Minor2			Minor1			Major1			Major2		
Conflicting Flow All	2067	2069	1010	2070	2072	1050	1011	0	0	1050	0	0
Stage 1	1013	1013	-	1056	1056	-	-	-	-	-	-	-
Stage 2	1054	1056	-	1014	1016	-	-	-	-	-	-	-
Critical Hdwy	7.1	6.5	6.2	7.1	6.5	6.2	4.1	-	-	4.1	-	-
Critical Hdwy Stg 1	6.1	5.5	-	6.1	5.5	-	-	-	-	-	-	-
Critical Hdwy Stg 2	6.1	5.5	-	6.1	5.5	-	-	-	-	-	-	-
Follow-up Hdwy	3.5	4	3.3	3.5	4	3.3	2.2	-	-	2.2	-	-
Pot Cap-1 Maneuver	40	55	294	40	55	278	694	-	-	671	-	-
Stage 1	291	319	-	275	305	-	-	-	-	-	-	-
Stage 2	276	305	-	290	318	-	-	-	-	-	-	-
Platoon blocked, %												
Mov Cap-1 Maneuver	39	54	294	40	54	277	693	-	-	671	-	-
Mov Cap-2 Maneuver	39	54	-	40	54	-	-	-	-	-	-	-
Stage 1	290	318	-	273	303	-	-	-	-	-	-	-
Stage 2	273	303	-	289	317	-	-	-	-	-	-	-

Approach	EB	WB	NB	SB
HCM Control Delay, s	0	59.7	0	0
HCM LOS	A	F		

Minor Lane/Major Mvmt	NBL	NBT	NBR	EBLn1	WBLn1	SBL	SBT	SBR
Capacity (veh/h)	693	-	-	-	70	671	-	-
HCM Lane V/C Ratio	0.005	-	-	-	0.06	0.003	-	-
HCM Control Delay (s)	10.2	-	-	0	59.7	10.4	-	-
HCM Lane LOS	B	-	-	A	F	B	-	-
HCM 95th %tile Q(veh)	0	-	-	-	0.2	0	-	-

Intersection

Int Delay, s/veh 0.2

Movement	WBL	WBR	NBT	NBR	SBL	SBT
Lane Configurations	Y		P		T	T
Traffic Vol, veh/h	0	13	987	0	10	958
Future Vol, veh/h	0	13	987	0	10	958
Conflicting Peds, #/hr	0	0	0	1	1	0
Sign Control	Stop	Stop	Free	Free	Free	Free
RT Channelized	-	None	-	None	-	None
Storage Length	0	-	-	-	65	-
Veh in Median Storage, #	0	-	0	-	-	0
Grade, %	0	-	0	-	-	0
Peak Hour Factor	93	93	93	93	93	93
Heavy Vehicles, %	0	9	2	0	0	1
Mvmt Flow	0	14	1061	0	11	1030

Major/Minor	Minor1		Major1		Major2	
Conflicting Flow All	2114	1062	0	0	1062	0
Stage 1	1062	-	-	-	-	-
Stage 2	1052	-	-	-	-	-
Critical Hdwy	6.4	6.29	-	-	4.1	-
Critical Hdwy Stg 1	5.4	-	-	-	-	-
Critical Hdwy Stg 2	5.4	-	-	-	-	-
Follow-up Hdwy	3.5	3.381	-	-	2.2	-
Pot Cap-1 Maneuver	57	263	-	-	664	-
Stage 1	335	-	-	-	-	-
Stage 2	339	-	-	-	-	-
Platoon blocked, %			-	-		-
Mov Cap-1 Maneuver	56	263	-	-	664	-
Mov Cap-2 Maneuver	56	-	-	-	-	-
Stage 1	335	-	-	-	-	-
Stage 2	333	-	-	-	-	-

Approach	WB		NB		SB
HCM Control Delay, s	19.5		0		0.1
HCM LOS	C				

Minor Lane/Major Mvmt	NBT	NBRWBLn1	SBL	SBT
Capacity (veh/h)	-	- 263	664	-
HCM Lane V/C Ratio	-	- 0.053	0.016	-
HCM Control Delay (s)	-	- 19.5	10.5	-
HCM Lane LOS	-	- C	B	-
HCM 95th %tile Q(veh)	-	- 0.2	0	-

Intersection

Int Delay, s/veh 6.4

Movement	WBL	WBR	NBT	NBR	SBL	SBT
Lane Configurations	Y		P			A
Traffic Vol, veh/h	4	16	2	3	7	3
Future Vol, veh/h	4	16	2	3	7	3
Conflicting Peds, #/hr	2	0	0	0	0	0
Sign Control	Stop	Stop	Free	Free	Free	Free
RT Channelized	-	None	-	None	-	None
Storage Length	0	-	-	-	-	-
Veh in Median Storage, #	0	-	0	-	-	0
Grade, %	0	-	0	-	-	0
Peak Hour Factor	75	75	75	75	75	75
Heavy Vehicles, %	33	8	0	0	0	0
Mvmt Flow	5	21	3	4	9	4

Major/Minor	Minor1		Major1		Major2	
Conflicting Flow All	30	5	0	0	7	0
Stage 1	5	-	-	-	-	-
Stage 2	25	-	-	-	-	-
Critical Hdwy	6.73	6.28	-	-	4.1	-
Critical Hdwy Stg 1	5.73	-	-	-	-	-
Critical Hdwy Stg 2	5.73	-	-	-	-	-
Follow-up Hdwy	3.797	3.372	-	-	2.2	-
Pot Cap-1 Maneuver	911	1061	-	-	1627	-
Stage 1	943	-	-	-	-	-
Stage 2	923	-	-	-	-	-
Platoon blocked, %			-	-		-
Mov Cap-1 Maneuver	904	1061	-	-	1627	-
Mov Cap-2 Maneuver	904	-	-	-	-	-
Stage 1	943	-	-	-	-	-
Stage 2	916	-	-	-	-	-

Approach	WB		NB		SB
HCM Control Delay, s	8.6		0		5.1
HCM LOS	A				

Minor Lane/Major Mvmt	NBT	NBRWBLn1	SBL	SBT
Capacity (veh/h)	-	- 1025	1627	-
HCM Lane V/C Ratio	-	- 0.026	0.006	-
HCM Control Delay (s)	-	- 8.6	7.2	0
HCM Lane LOS	-	- A	A	A
HCM 95th %tile Q(veh)	-	- 0.1	0	-

Intersection

Int Delay, s/veh 6

Movement	EBT	EBR	WBL	WBT	NBL	NBR
Lane Configurations	↔		↔		↔	
Traffic Vol, veh/h	3	6	2	0	16	2
Future Vol, veh/h	3	6	2	0	16	2
Conflicting Peds, #/hr	0	1	1	0	0	0
Sign Control	Free	Free	Free	Free	Stop	Stop
RT Channelized	-	None	-	None	-	None
Storage Length	-	-	-	-	0	-
Veh in Median Storage, #	0	-	-	0	0	-
Grade, %	0	-	-	0	0	-
Peak Hour Factor	79	79	79	79	79	79
Heavy Vehicles, %	0	0	100	0	15	0
Mvmt Flow	4	8	3	0	20	3

Major/Minor	Major1	Major2	Minor1	Minor2
Conflicting Flow All	0	0	12	0
Stage 1	-	-	-	-
Stage 2	-	-	-	-
Critical Hdwy	-	-	5.1	-
Critical Hdwy Stg 1	-	-	-	-
Critical Hdwy Stg 2	-	-	-	-
Follow-up Hdwy	-	-	3.1	-
Pot Cap-1 Maneuver	-	-	1148	-
Stage 1	-	-	-	-
Stage 2	-	-	-	-
Platoon blocked, %	-	-	-	-
Mov Cap-1 Maneuver	-	-	1148	-
Mov Cap-2 Maneuver	-	-	-	-
Stage 1	-	-	-	-
Stage 2	-	-	-	-

Approach	EB	WB	NB
HCM Control Delay, s	0	8.1	8.8
HCM LOS			A

Minor Lane/Major Mvmt	NBLn1	EBT	EBR	WBL	WBT
Capacity (veh/h)	978	-	-	1148	-
HCM Lane V/C Ratio	0.023	-	-	0.002	-
HCM Control Delay (s)	8.8	-	-	8.1	0
HCM Lane LOS	A	-	-	A	A
HCM 95th %tile Q(veh)	0.1	-	-	0	-

Intersection

Int Delay, s/veh 1.1

Movement	EBL	EBT	EBR	WBL	WBT	WBR	NBL	NBT	NBR	SBL	SBT	SBR
Lane Configurations		↔			↔		↑	↑		↑	↑	
Traffic Vol, veh/h	0	0	7	7	2	29	11	713	3	26	928	6
Future Vol, veh/h	0	0	7	7	2	29	11	713	3	26	928	6
Conflicting Peds, #/hr	0	0	0	0	0	0	0	0	1	1	0	0
Sign Control	Stop	Stop	Stop	Stop	Stop	Stop	Free	Free	Free	Free	Free	Free
RT Channelized	-	-	None	-	-	None	-	-	None	-	-	None
Storage Length	-	-	-	-	-	-	125	-	-	125	-	-
Veh in Median Storage, #	-	0	-	-	0	-	-	0	-	-	0	-
Grade, %	-	0	-	-	0	-	-	0	-	-	0	-
Peak Hour Factor	95	95	95	95	95	95	95	95	95	95	95	95
Heavy Vehicles, %	0	0	0	17	0	4	0	3	0	5	1	0
Mvmt Flow	0	0	7	7	2	31	12	751	3	27	977	6

Major/Minor	Minor2			Minor1			Major1			Major2		
Conflicting Flow All	1827	1813	980	1814	1814	753	983	0	0	755	0	0
Stage 1	1035	1035	-	776	776	-	-	-	-	-	-	-
Stage 2	792	778	-	1038	1038	-	-	-	-	-	-	-
Critical Hdwy	7.1	6.5	6.2	7.27	6.5	6.24	4.1	-	-	4.15	-	-
Critical Hdwy Stg 1	6.1	5.5	-	6.27	5.5	-	-	-	-	-	-	-
Critical Hdwy Stg 2	6.1	5.5	-	6.27	5.5	-	-	-	-	-	-	-
Follow-up Hdwy	3.5	4	3.3	3.653	4	3.336	2.2	-	-	2.245	-	-
Pot Cap-1 Maneuver	60	79	306	55	79	406	711	-	-	842	-	-
Stage 1	282	312	-	369	410	-	-	-	-	-	-	-
Stage 2	385	410	-	261	311	-	-	-	-	-	-	-
Platoon blocked, %												
Mov Cap-1 Maneuver	52	75	306	52	75	406	711	-	-	842	-	-
Mov Cap-2 Maneuver	52	75	-	52	75	-	-	-	-	-	-	-
Stage 1	277	302	-	362	403	-	-	-	-	-	-	-
Stage 2	348	403	-	247	301	-	-	-	-	-	-	-

Approach	EB	WB	NB	SB
HCM Control Delay, s	17.1	34.1	0.2	0.3
HCM LOS	C	D		

Minor Lane/Major Mvmt	NBL	NBT	NBR	EBLn1	WBLn1	SBL	SBT	SBR
Capacity (veh/h)	711	-	-	306	163	842	-	-
HCM Lane V/C Ratio	0.016	-	-	0.024	0.245	0.033	-	-
HCM Control Delay (s)	10.1	-	-	17.1	34.1	9.4	-	-
HCM Lane LOS	B	-	-	C	D	A	-	-
HCM 95th %tile Q(veh)	0.1	-	-	0.1	0.9	0.1	-	-

Intersection												
Int Delay, s/veh	5.8											
Movement	EBL	EBT	EBR	WBL	WBT	WBR	NBL	NBT	NBR	SBL	SBT	SBR
Lane Configurations		↕			↕		↕	↕		↕	↕	
Traffic Vol, veh/h	7	4	25	27	4	27	33	697	42	9	928	9
Future Vol, veh/h	7	4	25	27	4	27	33	697	42	9	928	9
Conflicting Peds, #/hr	0	0	0	0	0	0	1	0	0	0	0	1
Sign Control	Stop	Stop	Stop	Stop	Stop	Stop	Free	Free	Free	Free	Free	Free
RT Channelized	-	-	None	-	-	None	-	-	None	-	-	None
Storage Length	-	-	-	-	-	-	80	-	-	125	-	-
Veh in Median Storage, #	-	0	-	-	0	-	-	0	-	-	0	-
Grade, %	-	0	-	-	0	-	-	0	-	-	0	-
Peak Hour Factor	93	93	93	93	93	93	93	93	93	93	93	93
Heavy Vehicles, %	2	2	2	2	2	2	2	2	2	2	2	2
Mvmt Flow	8	4	27	29	4	29	35	749	45	10	998	10

Major/Minor	Minor2		Minor1		Major1		Major2					
Conflicting Flow All	1882	1888	1004	1881	1871	772	1009	0	0	794	0	0
Stage 1	1024	1024	-	842	842	-	-	-	-	-	-	-
Stage 2	858	864	-	1039	1029	-	-	-	-	-	-	-
Critical Hdwy	7.12	6.52	6.22	7.12	6.52	6.22	4.12	-	-	4.12	-	-
Critical Hdwy Stg 1	6.12	5.52	-	6.12	5.52	-	-	-	-	-	-	-
Critical Hdwy Stg 2	6.12	5.52	-	6.12	5.52	-	-	-	-	-	-	-
Follow-up Hdwy	3.518	4.018	3.318	3.518	4.018	3.318	2.218	-	-	2.218	-	-
Pot Cap-1 Maneuver	54	70	294	54	72	400	687	-	-	827	-	-
Stage 1	284	313	-	359	380	-	-	-	-	-	-	-
Stage 2	352	371	-	279	311	-	-	-	-	-	-	-
Platoon blocked, %								-	-	-	-	-
Mov Cap-1 Maneuver	45	66	294	44	67	400	686	-	-	827	-	-
Mov Cap-2 Maneuver	45	66	-	44	67	-	-	-	-	-	-	-
Stage 1	269	309	-	341	361	-	-	-	-	-	-	-
Stage 2	306	352	-	247	307	-	-	-	-	-	-	-

Approach	EB		WB		NB		SB	
HCM Control Delay, s	48.7		142.6		0.5		0.1	
HCM LOS	E		F					

Minor Lane/Major Mvmt	NBL	NBT	NBR	EBLn1	WBLn1	SBL	SBT	SBR
Capacity (veh/h)	686	-	-	120	78	827	-	-
HCM Lane V/C Ratio	0.052	-	-	0.323	0.8	0.012	-	-
HCM Control Delay (s)	10.5	-	-	48.7	142.6	9.4	-	-
HCM Lane LOS	B	-	-	E	F	A	-	-
HCM 95th %tile Q(veh)	0.2	-	-	1.3	4	0	-	-

Intersection												
Int Delay, s/veh	4.6											
Movement	EBL	EBT	EBR	WBL	WBT	WBR	NBL	NBT	NBR	SBL	SBT	SBR
Lane Configurations		↔			↔			↔			↔	
Traffic Vol, veh/h	29	39	3	6	36	20	12	11	4	7	20	10
Future Vol, veh/h	29	39	3	6	36	20	12	11	4	7	20	10
Conflicting Peds, #/hr	1	0	0	0	0	1	0	0	2	2	0	0
Sign Control	Free	Free	Free	Free	Free	Free	Stop	Stop	Stop	Stop	Stop	Stop
RT Channelized	-	-	None	-	-	None	-	-	None	-	-	None
Storage Length	-	-	-	-	-	-	-	-	-	-	-	-
Veh in Median Storage, #	-	0	-	-	0	-	-	0	-	-	0	-
Grade, %	-	0	-	-	0	-	-	0	-	-	0	-
Peak Hour Factor	83	83	83	83	83	83	83	83	83	83	83	83
Heavy Vehicles, %	0	0	0	0	0	0	0	0	0	0	0	0
Mvmt Flow	35	47	4	7	43	24	14	13	5	8	24	12
Major/Minor	Major1			Major2			Minor1			Minor2		
Conflicting Flow All	68	0	0	51	0	0	207	202	51	201	191	56
Stage 1	-	-	-	-	-	-	119	119	-	71	71	-
Stage 2	-	-	-	-	-	-	88	83	-	130	120	-
Critical Hdwy	4.1	-	-	4.1	-	-	7.1	6.5	6.2	7.1	6.5	6.2
Critical Hdwy Stg 1	-	-	-	-	-	-	6.1	5.5	-	6.1	5.5	-
Critical Hdwy Stg 2	-	-	-	-	-	-	6.1	5.5	-	6.1	5.5	-
Follow-up Hdwy	2.2	-	-	2.2	-	-	3.5	4	3.3	3.5	4	3.3
Pot Cap-1 Maneuver	1546	-	-	1568	-	-	755	698	1023	762	708	1016
Stage 1	-	-	-	-	-	-	890	801	-	944	840	-
Stage 2	-	-	-	-	-	-	925	830	-	878	800	-
Platoon blocked, %	-	-	-	-	-	-	-	-	-	-	-	-
Mov Cap-1 Maneuver	1546	-	-	1565	-	-	711	678	1021	729	688	1015
Mov Cap-2 Maneuver	-	-	-	-	-	-	711	678	-	729	688	-
Stage 1	-	-	-	-	-	-	870	783	-	921	835	-
Stage 2	-	-	-	-	-	-	883	825	-	838	782	-
Approach	EB			WB			NB			SB		
HCM Control Delay, s	3			0.7			10.2			10		
HCM LOS							B			B		
Minor Lane/Major Mvmt	NBLn1	EBL	EBT	EBR	WBL	WBT	WBR	SBLn1				
Capacity (veh/h)	729	1546	-	-	1565	-	-	763				
HCM Lane V/C Ratio	0.045	0.023	-	-	0.005	-	-	0.058				
HCM Control Delay (s)	10.2	7.4	0	-	7.3	0	-	10				
HCM Lane LOS	B	A	A	-	A	A	-	B				
HCM 95th %tile Q(veh)	0.1	0.1	-	-	0	-	-	0.2				

Intersection

Int Delay, s/veh 6.9

Movement	EBL	EBT	EBR	WBL	WBT	WBR	NBL	NBT	NBR	SBL	SBT	SBR
Lane Configurations		↕			↕			↕			↕	
Traffic Vol, veh/h	3	43	4	12	43	3	9	16	9	10	19	4
Future Vol, veh/h	3	43	4	12	43	3	9	16	9	10	19	4
Conflicting Peds, #/hr	4	0	0	0	0	4	1	0	1	1	0	1
Sign Control	Stop	Stop	Stop	Stop	Stop	Stop	Free	Free	Free	Free	Free	Free
RT Channelized	-	-	None	-	-	None	-	-	None	-	-	None
Storage Length	-	-	-	-	-	-	-	-	-	-	-	-
Veh in Median Storage, #	-	0	-	-	0	-	-	0	-	-	0	-
Grade, %	-	0	-	-	0	-	-	0	-	-	0	-
Peak Hour Factor	84	84	84	84	84	84	84	84	84	84	84	84
Heavy Vehicles, %	0	0	0	0	0	0	0	8	14	0	6	0
Mvmt Flow	4	51	5	14	51	4	11	19	11	12	23	5

Major/Minor	Minor2			Minor1			Major1			Major2		
Conflicting Flow All	127	102	26	124	99	29	28	0	0	31	0	0
Stage 1	50	50	-	47	47	-	-	-	-	-	-	-
Stage 2	77	52	-	77	52	-	-	-	-	-	-	-
Critical Hdwy	7.1	6.5	6.2	7.1	6.5	6.2	4.1	-	-	4.1	-	-
Critical Hdwy Stg 1	6.1	5.5	-	6.1	5.5	-	-	-	-	-	-	-
Critical Hdwy Stg 2	6.1	5.5	-	6.1	5.5	-	-	-	-	-	-	-
Follow-up Hdwy	3.5	4	3.3	3.5	4	3.3	2.2	-	-	2.2	-	-
Pot Cap-1 Maneuver	851	792	1056	855	795	1052	1599	-	-	1595	-	-
Stage 1	968	857	-	972	860	-	-	-	-	-	-	-
Stage 2	937	856	-	937	856	-	-	-	-	-	-	-
Platoon blocked, %												
Mov Cap-1 Maneuver	793	779	1055	799	782	1047	1599	-	-	1589	-	-
Mov Cap-2 Maneuver	793	779	-	799	782	-	-	-	-	-	-	-
Stage 1	960	849	-	964	853	-	-	-	-	-	-	-
Stage 2	868	849	-	870	848	-	-	-	-	-	-	-

Approach	EB	WB	NB	SB
HCM Control Delay, s	9.9	10	1.9	2.2
HCM LOS	A	B		

Minor Lane/Major Mvmt	NBL	NBT	NBR	EBLn1	WBLn1	SBL	SBT	SBR
Capacity (veh/h)	1599	-	-	797	796	1589	-	-
HCM Lane V/C Ratio	0.007	-	-	0.075	0.087	0.007	-	-
HCM Control Delay (s)	7.3	0	-	9.9	10	7.3	0	-
HCM Lane LOS	A	A	-	A	B	A	A	-
HCM 95th %tile Q(veh)	0	-	-	0.2	0.3	0	-	-

Intersection	
Intersection Delay, s/veh	7.2
Intersection LOS	A

Movement	EBU	EBL	EBT	EBR	WBU	WBL	WBT	WBR	NBU	NBL	NBT	NBR
Lane Configurations			↕				↕				↕	
Traffic Vol, veh/h	0	5	52	4	0	3	47	0	0	5	2	5
Future Vol, veh/h	0	5	52	4	0	3	47	0	0	5	2	5
Peak Hour Factor	0.92	0.83	0.83	0.83	0.92	0.83	0.83	0.83	0.92	0.83	0.83	0.83
Heavy Vehicles, %	2	0	2	0	2	0	0	0	2	0	0	0
Mvmt Flow	0	6	63	5	0	4	57	0	0	6	2	6
Number of Lanes	0	0	1	0	0	0	1	0	0	0	1	0

Approach	EB	WB	NB
Opposing Approach	WB	EB	SB
Opposing Lanes	1	1	1
Conflicting Approach Left	SB	NB	EB
Conflicting Lanes Left	1	1	1
Conflicting Approach Right	NB	SB	WB
Conflicting Lanes Right	1	1	1
HCM Control Delay	7.3	7.3	7.1
HCM LOS	A	A	A

Lane	NBLn1	EBLn1	WBLn1	SBLn1
Vol Left, %	42%	8%	6%	0%
Vol Thru, %	17%	85%	94%	22%
Vol Right, %	42%	7%	0%	78%
Sign Control	Stop	Stop	Stop	Stop
Traffic Vol by Lane	12	61	50	9
LT Vol	5	5	3	0
Through Vol	2	52	47	2
RT Vol	5	4	0	7
Lane Flow Rate	14	73	60	11
Geometry Grp	1	1	1	1
Degree of Util (X)	0.016	0.081	0.067	0.011
Departure Headway (Hd)	3.973	3.968	4.012	3.675
Convergence, Y/N	Yes	Yes	Yes	Yes
Cap	894	904	893	965
Service Time	2.029	1.986	2.033	1.733
HCM Lane V/C Ratio	0.016	0.081	0.067	0.011
HCM Control Delay	7.1	7.3	7.3	6.8
HCM Lane LOS	A	A	A	A
HCM 95th-tile Q	0	0.3	0.2	0

Intersection

Intersection Delay, s/veh
 Intersection LOS

Movement	SBU	SBL	SBT	SBR
Lane Configurations			↕	
Traffic Vol, veh/h	0	0	2	7
Future Vol, veh/h	0	0	2	7
Peak Hour Factor	0.92	0.83	0.83	0.83
Heavy Vehicles, %	2	0	0	0
Mvmt Flow	0	0	2	8
Number of Lanes	0	0	1	0

Approach SB

Opposing Approach	NB
Opposing Lanes	1
Conflicting Approach Left	WB
Conflicting Lanes Left	1
Conflicting Approach Right	EB
Conflicting Lanes Right	1
HCM Control Delay	6.8
HCM LOS	A

APPENDIX 8. CUMULATIVE WITH PROJECT OPERATIONS RESULTS

Intersection

Int Delay, s/veh 0.8

Movement	WBL	WBR	NBT	NBR	SBL	SBT
Lane Configurations	↕		↑	↗		↖
Traffic Vol, veh/h	17	9	872	18	2	958
Future Vol, veh/h	17	9	872	18	2	958
Conflicting Peds, #/hr	0	0	0	0	0	0
Sign Control	Stop	Stop	Free	Free	Free	Free
RT Channelized	-	None	-	None	-	None
Storage Length	0	-	-	125	-	-
Veh in Median Storage, #	0	-	0	-	-	0
Grade, %	0	-	0	-	-	0
Peak Hour Factor	92	92	92	92	92	92
Heavy Vehicles, %	0	0	6	0	0	4
Mvmt Flow	18	10	948	20	2	1041

Major/Minor	Minor1		Major1		Major2	
Conflicting Flow All	1994	948	0	0	948	0
Stage 1	948	-	-	-	-	-
Stage 2	1046	-	-	-	-	-
Critical Hdwy	6.4	6.2	-	-	4.1	-
Critical Hdwy Stg 1	5.4	-	-	-	-	-
Critical Hdwy Stg 2	5.4	-	-	-	-	-
Follow-up Hdwy	3.5	3.3	-	-	2.2	-
Pot Cap-1 Maneuver	67	319	-	-	732	-
Stage 1	380	-	-	-	-	-
Stage 2	341	-	-	-	-	-
Platoon blocked, %			-	-		
Mov Cap-1 Maneuver	67	319	-	-	732	-
Mov Cap-2 Maneuver	67	-	-	-	-	-
Stage 1	380	-	-	-	-	-
Stage 2	339	-	-	-	-	-

Approach	WB		NB		SB
HCM Control Delay, s	60.6		0		0
HCM LOS	F				

Minor Lane/Major Mvmt	NBT	NBRWBLn1	SBL	SBT
Capacity (veh/h)	-	-	92	732
HCM Lane V/C Ratio	-	-	0.307	0.003
HCM Control Delay (s)	-	-	60.6	9.9
HCM Lane LOS	-	-	F	A
HCM 95th %tile Q(veh)	-	-	1.2	0

Intersection

Int Delay, s/veh 0.3

Movement	EBL	EBT	EBR	WBL	WBT	WBR	NBL	NBT	NBR	SBL	SBT	SBR
Lane Configurations		↔			↔		↑	↑		↑	↑	
Traffic Vol, veh/h	5	0	2	0	0	0	0	878	0	0	1001	5
Future Vol, veh/h	5	0	2	0	0	0	0	878	0	0	1001	5
Conflicting Peds, #/hr	1	0	0	0	0	1	1	0	1	1	0	1
Sign Control	Stop	Stop	Stop	Stop	Stop	Stop	Free	Free	Free	Free	Free	Free
RT Channelized	-	-	None	-	-	None	-	-	None	-	-	None
Storage Length	-	-	-	-	-	-	65	-	-	50	-	-
Veh in Median Storage, #	-	0	-	-	0	-	-	0	-	-	0	-
Grade, %	-	0	-	-	0	-	-	0	-	-	0	-
Peak Hour Factor	93	93	93	93	93	93	93	93	93	93	93	93
Heavy Vehicles, %	0	0	0	0	0	0	0	6	0	0	4	0
Mvmt Flow	5	0	2	0	0	0	0	944	0	0	1076	5

Major/Minor	Minor2			Minor1			Major1			Major2		
Conflicting Flow All	2025	2025	1080	2025	2028	946	1083	0	0	945	0	0
Stage 1	1080	1080	-	945	945	-	-	-	-	-	-	-
Stage 2	945	945	-	1080	1083	-	-	-	-	-	-	-
Critical Hdwy	7.1	6.5	6.2	7.1	6.5	6.2	4.1	-	-	4.1	-	-
Critical Hdwy Stg 1	6.1	5.5	-	6.1	5.5	-	-	-	-	-	-	-
Critical Hdwy Stg 2	6.1	5.5	-	6.1	5.5	-	-	-	-	-	-	-
Follow-up Hdwy	3.5	4	3.3	3.5	4	3.3	2.2	-	-	2.2	-	-
Pot Cap-1 Maneuver	43	58	268	43	58	320	652	-	-	734	-	-
Stage 1	267	297	-	317	343	-	-	-	-	-	-	-
Stage 2	317	343	-	267	296	-	-	-	-	-	-	-
Platoon blocked, %												
Mov Cap-1 Maneuver	43	58	268	43	58	319	652	-	-	733	-	-
Mov Cap-2 Maneuver	43	58	-	43	58	-	-	-	-	-	-	-
Stage 1	267	297	-	317	343	-	-	-	-	-	-	-
Stage 2	317	343	-	265	296	-	-	-	-	-	-	-

Approach	EB	WB	NB	SB
HCM Control Delay, s	77.5	0	0	0
HCM LOS	F	A		

Minor Lane/Major Mvmt	NBL	NBT	NBR	EBLn1WBLn1	SBL	SBT	SBR
Capacity (veh/h)	652	-	-	57	-	733	-
HCM Lane V/C Ratio	-	-	-	0.132	-	-	-
HCM Control Delay (s)	0	-	-	77.5	0	0	-
HCM Lane LOS	A	-	-	F	A	A	-
HCM 95th %tile Q(veh)	0	-	-	0.4	-	0	-

Intersection

Int Delay, s/veh 1.2

Movement	WBL	WBR	NBT	NBR	SBL	SBT
Lane Configurations	Y		P		T	T
Traffic Vol, veh/h	14	42	809	4	10	980
Future Vol, veh/h	14	42	809	4	10	980
Conflicting Peds, #/hr	0	0	0	0	0	0
Sign Control	Stop	Stop	Free	Free	Free	Free
RT Channelized	-	None	-	None	-	None
Storage Length	0	-	-	-	65	-
Veh in Median Storage, #	0	-	0	-	-	0
Grade, %	0	-	0	-	-	0
Peak Hour Factor	92	92	92	92	92	92
Heavy Vehicles, %	0	0	6	0	0	4
Mvmt Flow	15	46	879	4	11	1065

Major/Minor	Minor1		Major1		Major2	
Conflicting Flow All	1969	882	0	0	884	0
Stage 1	882	-	-	-	-	-
Stage 2	1087	-	-	-	-	-
Critical Hdwy	6.4	6.2	-	-	4.1	-
Critical Hdwy Stg 1	5.4	-	-	-	-	-
Critical Hdwy Stg 2	5.4	-	-	-	-	-
Follow-up Hdwy	3.5	3.3	-	-	2.2	-
Pot Cap-1 Maneuver	70	348	-	-	774	-
Stage 1	408	-	-	-	-	-
Stage 2	326	-	-	-	-	-
Platoon blocked, %			-	-		
Mov Cap-1 Maneuver	69	348	-	-	774	-
Mov Cap-2 Maneuver	69	-	-	-	-	-
Stage 1	408	-	-	-	-	-
Stage 2	321	-	-	-	-	-

Approach	WB		NB		SB
HCM Control Delay, s	36.7		0		0.1
HCM LOS	E				

Minor Lane/Major Mvmt	NBT	NBRWBLn1	SBL	SBT
Capacity (veh/h)	-	- 173	774	-
HCM Lane V/C Ratio	-	- 0.352	0.014	-
HCM Control Delay (s)	-	- 36.7	9.7	-
HCM Lane LOS	-	- E	A	-
HCM 95th %tile Q(veh)	-	- 1.5	0	-

Intersection						
Int Delay, s/veh	7.4					
Movement	WBL	WBR	NBT	NBR	SBL	SBT
Lane Configurations	Y		P			A
Traffic Vol, veh/h	2	26	2	0	6	2
Future Vol, veh/h	2	26	2	0	6	2
Conflicting Peds, #/hr	0	0	0	0	0	0
Sign Control	Stop	Stop	Free	Free	Free	Free
RT Channelized	-	None	-	None	-	None
Storage Length	0	-	-	-	-	-
Veh in Median Storage, #	0	-	0	-	-	0
Grade, %	0	-	0	-	-	0
Peak Hour Factor	75	75	75	75	75	75
Heavy Vehicles, %	0	0	0	0	0	0
Mvmt Flow	3	35	3	0	8	3
Major/Minor	Minor1		Major1		Major2	
Conflicting Flow All	22	3	0	0	3	0
Stage 1	3	-	-	-	-	-
Stage 2	19	-	-	-	-	-
Critical Hdwy	6.4	6.2	-	-	4.1	-
Critical Hdwy Stg 1	5.4	-	-	-	-	-
Critical Hdwy Stg 2	5.4	-	-	-	-	-
Follow-up Hdwy	3.5	3.3	-	-	2.2	-
Pot Cap-1 Maneuver	1000	1087	-	-	1632	-
Stage 1	1025	-	-	-	-	-
Stage 2	1009	-	-	-	-	-
Platoon blocked, %			-	-		-
Mov Cap-1 Maneuver	995	1087	-	-	1632	-
Mov Cap-2 Maneuver	995	-	-	-	-	-
Stage 1	1025	-	-	-	-	-
Stage 2	1004	-	-	-	-	-
Approach	WB		NB		SB	
HCM Control Delay, s	8.5		0		5.4	
HCM LOS	A					
Minor Lane/Major Mvmt	NBT	NBRWBLn1	SBL	SBT		
Capacity (veh/h)	-	- 1080	1632	-		
HCM Lane V/C Ratio	-	- 0.035	0.005	-		
HCM Control Delay (s)	-	- 8.5	7.2	0		
HCM Lane LOS	-	- A	A	A		
HCM 95th %tile Q(veh)	-	- 0.1	0	-		

Intersection

Int Delay, s/veh 5.5

Movement	EBT	EBR	WBL	WBT	NBL	NBR
Lane Configurations	↔			↔	↔	
Traffic Vol, veh/h	3	4	0	5	21	0
Future Vol, veh/h	3	4	0	5	21	0
Conflicting Peds, #/hr	0	0	0	0	0	1
Sign Control	Free	Free	Free	Free	Stop	Stop
RT Channelized	-	None	-	None	-	None
Storage Length	-	-	-	-	0	-
Veh in Median Storage, #	0	-	-	0	0	-
Grade, %	0	-	-	0	0	-
Peak Hour Factor	70	70	70	70	70	70
Heavy Vehicles, %	0	0	0	0	0	0
Mvmt Flow	4	6	0	7	30	0

Major/Minor	Major1	Major2	Minor1
Conflicting Flow All	0	10	14
Stage 1	-	-	7
Stage 2	-	-	7
Critical Hdwy	-	4.1	6.4
Critical Hdwy Stg 1	-	-	5.4
Critical Hdwy Stg 2	-	-	5.4
Follow-up Hdwy	-	2.2	3.5
Pot Cap-1 Maneuver	-	1623	1010
Stage 1	-	-	1021
Stage 2	-	-	1021
Platoon blocked, %	-	-	-
Mov Cap-1 Maneuver	-	1621	1010
Mov Cap-2 Maneuver	-	-	1010
Stage 1	-	-	1021
Stage 2	-	-	1021

Approach	EB	WB	NB
HCM Control Delay, s	0	0	8.7
HCM LOS			A

Minor Lane/Major Mvmt	NBLn1	EBT	EBR	WBL	WBT
Capacity (veh/h)	1010	-	-	1621	-
HCM Lane V/C Ratio	0.03	-	-	-	-
HCM Control Delay (s)	8.7	-	-	0	-
HCM Lane LOS	A	-	-	A	-
HCM 95th %tile Q(veh)	0.1	-	-	0	-

Intersection												
Int Delay, s/veh	0.9											
Movement	EBL	EBT	EBR	WBL	WBT	WBR	NBL	NBT	NBR	SBL	SBT	SBR
Lane Configurations		↔			↔		↖	↗		↖	↗	
Traffic Vol, veh/h	4	0	6	3	0	31	5	760	5	12	965	0
Future Vol, veh/h	4	0	6	3	0	31	5	760	5	12	965	0
Conflicting Peds, #/hr	0	0	0	0	0	0	1	0	0	0	0	1
Sign Control	Stop	Stop	Stop	Stop	Stop	Stop	Free	Free	Free	Free	Free	Free
RT Channelized	-	-	None	-	-	None	-	-	None	-	-	None
Storage Length	-	-	-	-	-	-	125	-	-	125	-	-
Veh in Median Storage, #	-	0	-	-	0	-	-	0	-	-	0	-
Grade, %	-	0	-	-	0	-	-	0	-	-	0	-
Peak Hour Factor	90	90	90	90	90	90	90	90	90	90	90	90
Heavy Vehicles, %	0	0	0	0	0	4	0	6	0	0	4	0
Mvmt Flow	4	0	7	3	0	34	6	844	6	13	1072	0
Major/Minor	Minor2			Minor1			Major1			Major2		
Conflicting Flow All	1976	1961	1073	1960	1958	847	1073	0	0	850	0	0
Stage 1	1100	1100	-	858	858	-	-	-	-	-	-	-
Stage 2	876	861	-	1102	1100	-	-	-	-	-	-	-
Critical Hdwy	7.1	6.5	6.2	7.1	6.5	6.24	4.1	-	-	4.1	-	-
Critical Hdwy Stg 1	6.1	5.5	-	6.1	5.5	-	-	-	-	-	-	-
Critical Hdwy Stg 2	6.1	5.5	-	6.1	5.5	-	-	-	-	-	-	-
Follow-up Hdwy	3.5	4	3.3	3.5	4	3.336	2.2	-	-	2.2	-	-
Pot Cap-1 Maneuver	47	64	270	48	64	359	657	-	-	797	-	-
Stage 1	260	290	-	354	376	-	-	-	-	-	-	-
Stage 2	346	375	-	259	290	-	-	-	-	-	-	-
Platoon blocked, %												
Mov Cap-1 Maneuver	42	62	270	46	62	359	657	-	-	797	-	-
Mov Cap-2 Maneuver	42	62	-	46	62	-	-	-	-	-	-	-
Stage 1	257	285	-	351	373	-	-	-	-	-	-	-
Stage 2	310	372	-	248	285	-	-	-	-	-	-	-
Approach	EB			WB			NB			SB		
HCM Control Delay, s	53.6			24.3			0.1			0.1		
HCM LOS	F			C								
Minor Lane/Major Mvmt	NBL	NBT	NBR	EBLn1	WBLn1	SBL	SBT	SBR				
Capacity (veh/h)	657	-	-	85	224	797	-	-				
HCM Lane V/C Ratio	0.008	-	-	0.131	0.169	0.017	-	-				
HCM Control Delay (s)	10.5	-	-	53.6	24.3	9.6	-	-				
HCM Lane LOS	B	-	-	F	C	A	-	-				
HCM 95th %tile Q(veh)	0	-	-	0.4	0.6	0.1	-	-				

Intersection												
Int Delay, s/veh	14.2											
Movement	EBL	EBT	EBR	WBL	WBT	WBR	NBL	NBT	NBR	SBL	SBT	SBR
Lane Configurations		↕			↕		↕	↕		↕	↕	
Traffic Vol, veh/h	12	0	13	56	0	18	9	756	25	7	957	7
Future Vol, veh/h	12	0	13	56	0	18	9	756	25	7	957	7
Conflicting Peds, #/hr	0	0	0	0	0	0	1	0	0	0	0	1
Sign Control	Stop	Stop	Stop	Stop	Stop	Stop	Free	Free	Free	Free	Free	Free
RT Channelized	-	-	None	-	-	None	-	-	None	-	-	None
Storage Length	-	-	-	-	-	-	80	-	-	125	-	-
Veh in Median Storage, #	-	0	-	-	0	-	-	0	-	-	0	-
Grade, %	-	0	-	-	0	-	-	0	-	-	0	-
Peak Hour Factor	93	93	93	93	93	93	93	93	93	93	93	93
Heavy Vehicles, %	2	2	2	2	2	2	2	2	2	2	2	2
Mvmt Flow	13	0	14	60	0	19	10	813	27	8	1029	8

Major/Minor	Minor2		Minor1		Major1		Major2					
Conflicting Flow All	1906	1910	1034	1903	1901	827	1038	0	0	840	0	0
Stage 1	1050	1050	-	847	847	-	-	-	-	-	-	-
Stage 2	856	860	-	1056	1054	-	-	-	-	-	-	-
Critical Hdwy	7.12	6.52	6.22	7.12	6.52	6.22	4.12	-	-	4.12	-	-
Critical Hdwy Stg 1	6.12	5.52	-	6.12	5.52	-	-	-	-	-	-	-
Critical Hdwy Stg 2	6.12	5.52	-	6.12	5.52	-	-	-	-	-	-	-
Follow-up Hdwy	3.518	4.018	3.318	3.518	4.018	3.318	2.218	-	-	2.218	-	-
Pot Cap-1 Maneuver	52	68	282	~ 52	69	371	670	-	-	795	-	-
Stage 1	275	304	-	357	378	-	-	-	-	-	-	-
Stage 2	352	373	-	272	303	-	-	-	-	-	-	-
Platoon blocked, %								-	-	-	-	-
Mov Cap-1 Maneuver	48	66	282	~ 48	67	371	669	-	-	795	-	-
Mov Cap-2 Maneuver	48	66	-	~ 48	67	-	-	-	-	-	-	-
Stage 1	271	301	-	352	372	-	-	-	-	-	-	-
Stage 2	329	367	-	256	300	-	-	-	-	-	-	-

Approach	EB		WB		NB		SB	
HCM Control Delay, s	66.8		\$ 330.8		0.1		0.1	
HCM LOS	F		F					

Minor Lane/Major Mvmt	NBL	NBT	NBR	EBLn1	WBLn1	SBL	SBT	SBR
Capacity (veh/h)	669	-	-	84	61	795	-	-
HCM Lane V/C Ratio	0.014	-	-	0.32	1.304	0.009	-	-
HCM Control Delay (s)	10.5	-	-	66.8	\$ 330.8	9.6	-	-
HCM Lane LOS	B	-	-	F	F	A	-	-
HCM 95th %tile Q(veh)	0	-	-	1.2	6.7	0	-	-

Notes
 ~: Volume exceeds capacity \$: Delay exceeds 300s +: Computation Not Defined *: All major volume in platoon

Intersection

Int Delay, s/veh 1.9

Movement	EBL	EBT	EBR	WBL	WBT	WBR	NBL	NBT	NBR	SBL	SBT	SBR
Lane Configurations		↕			↕			↕			↕	
Traffic Vol, veh/h	7	19	0	2	76	0	4	3	0	3	3	4
Future Vol, veh/h	7	19	0	2	76	0	4	3	0	3	3	4
Conflicting Peds, #/hr	1	0	0	0	0	1	0	0	1	1	0	0
Sign Control	Free	Free	Free	Free	Free	Free	Stop	Stop	Stop	Stop	Stop	Stop
RT Channelized	-	-	None	-	-	None	-	-	None	-	-	None
Storage Length	-	-	-	-	-	-	-	-	-	-	-	-
Veh in Median Storage, #	-	0	-	-	0	-	-	0	-	-	0	-
Grade, %	-	0	-	-	0	-	-	0	-	-	0	-
Peak Hour Factor	74	74	74	74	74	74	74	74	74	74	74	74
Heavy Vehicles, %	0	0	0	0	0	0	33	0	0	0	0	0
Mvmt Flow	9	26	0	3	103	0	5	4	0	4	4	5

Major/Minor	Major1			Major2			Minor1			Minor2		
Conflicting Flow All	104	0	0	26	0	0	158	154	27	157	154	104
Stage 1	-	-	-	-	-	-	45	45	-	109	109	-
Stage 2	-	-	-	-	-	-	113	109	-	48	45	-
Critical Hdwy	4.1	-	-	4.1	-	-	7.43	6.5	6.2	7.1	6.5	6.2
Critical Hdwy Stg 1	-	-	-	-	-	-	6.43	5.5	-	6.1	5.5	-
Critical Hdwy Stg 2	-	-	-	-	-	-	6.43	5.5	-	6.1	5.5	-
Follow-up Hdwy	2.2	-	-	2.2	-	-	3.797	4	3.3	3.5	4	3.3
Pot Cap-1 Maneuver	1500	-	-	1601	-	-	743	741	1054	814	741	956
Stage 1	-	-	-	-	-	-	896	861	-	901	809	-
Stage 2	-	-	-	-	-	-	822	809	-	971	861	-
Platoon blocked, %		-	-		-	-						
Mov Cap-1 Maneuver	1500	-	-	1599	-	-	731	734	1053	804	734	955
Mov Cap-2 Maneuver	-	-	-	-	-	-	731	734	-	804	734	-
Stage 1	-	-	-	-	-	-	891	856	-	895	807	-
Stage 2	-	-	-	-	-	-	812	807	-	960	856	-

Approach	EB	WB	NB	SB
HCM Control Delay, s	2	0.2	10	9.4
HCM LOS			B	A

Minor Lane/Major Mvmt	NBLn1	EBL	EBT	EBR	WBL	WBT	WBR	SBLn1
Capacity (veh/h)	732	1500	-	-	1599	-	-	833
HCM Lane V/C Ratio	0.013	0.006	-	-	0.002	-	-	0.016
HCM Control Delay (s)	10	7.4	0	-	7.3	0	-	9.4
HCM Lane LOS	B	A	A	-	A	A	-	A
HCM 95th %tile Q(veh)	0	0	-	-	0	-	-	0

Intersection

Int Delay, s/veh 7.8

Movement	EBL	EBT	EBR	WBL	WBT	WBR	NBL	NBT	NBR	SBL	SBT	SBR
Lane Configurations		↕			↕			↕			↕	
Traffic Vol, veh/h	0	17	0	2	76	11	3	20	0	2	5	0
Future Vol, veh/h	0	17	0	2	76	11	3	20	0	2	5	0
Conflicting Peds, #/hr	1	0	0	0	0	1	0	0	0	0	0	0
Sign Control	Stop	Stop	Stop	Stop	Stop	Stop	Free	Free	Free	Free	Free	Free
RT Channelized	-	-	None	-	-	None	-	-	None	-	-	None
Storage Length	-	-	-	-	-	-	-	-	-	-	-	-
Veh in Median Storage, #	-	0	-	-	0	-	-	0	-	-	0	-
Grade, %	-	0	-	-	0	-	-	0	-	-	0	-
Peak Hour Factor	83	83	83	83	83	83	83	83	83	83	83	83
Heavy Vehicles, %	0	0	0	0	0	0	0	6	0	0	0	0
Mvmt Flow	0	20	0	2	92	13	4	24	0	2	6	0

Major/Minor	Minor2			Minor1			Major1			Major2		
Conflicting Flow All	96	42	6	52	42	25	6	0	0	24	0	0
Stage 1	11	11	-	31	31	-	-	-	-	-	-	-
Stage 2	85	31	-	21	11	-	-	-	-	-	-	-
Critical Hdwy	7.1	6.5	6.2	7.1	6.5	6.2	4.1	-	-	4.1	-	-
Critical Hdwy Stg 1	6.1	5.5	-	6.1	5.5	-	-	-	-	-	-	-
Critical Hdwy Stg 2	6.1	5.5	-	6.1	5.5	-	-	-	-	-	-	-
Follow-up Hdwy	3.5	4	3.3	3.5	4	3.3	2.2	-	-	2.2	-	-
Pot Cap-1 Maneuver	891	854	1083	952	854	1057	1628	-	-	1604	-	-
Stage 1	1015	890	-	991	873	-	-	-	-	-	-	-
Stage 2	928	873	-	1003	890	-	-	-	-	-	-	-
Platoon blocked, %												
Mov Cap-1 Maneuver	805	851	1083	932	851	1056	1628	-	-	1602	-	-
Mov Cap-2 Maneuver	805	851	-	932	851	-	-	-	-	-	-	-
Stage 1	1013	889	-	989	871	-	-	-	-	-	-	-
Stage 2	818	871	-	979	889	-	-	-	-	-	-	-

Approach	EB	WB	NB	SB
HCM Control Delay, s	9.3	9.7	0.9	2.1
HCM LOS	A	A		

Minor Lane/Major Mvmt	NBL	NBT	NBR	EBLn1WBLn1	SBL	SBT	SBR
Capacity (veh/h)	1628	-	-	851	874	1602	-
HCM Lane V/C Ratio	0.002	-	-	0.024	0.123	0.002	-
HCM Control Delay (s)	7.2	0	-	9.3	9.7	7.3	0
HCM Lane LOS	A	A	-	A	A	A	A
HCM 95th %tile Q(veh)	0	-	-	0.1	0.4	0	-

Intersection	
Intersection Delay, s/veh	7.3
Intersection LOS	A

Movement	EBU	EBL	EBT	EBR	WBU	WBL	WBT	WBR	NBU	NBL	NBT	NBR
Lane Configurations			↕				↕				↕	
Traffic Vol, veh/h	0	0	20	2	0	6	73	2	0	2	2	3
Future Vol, veh/h	0	0	20	2	0	6	73	2	0	2	2	3
Peak Hour Factor	0.92	0.90	0.90	0.90	0.92	0.90	0.90	0.90	0.92	0.90	0.90	0.90
Heavy Vehicles, %	2	0	6	0	2	0	0	0	2	0	0	0
Mvmt Flow	0	0	22	2	0	7	81	2	0	2	2	3
Number of Lanes	0	0	1	0	0	0	1	0	0	0	1	0

Approach	EB	WB	NB
Opposing Approach	WB	EB	SB
Opposing Lanes	1	1	1
Conflicting Approach Left	SB	NB	EB
Conflicting Lanes Left	1	1	1
Conflicting Approach Right	NB	SB	WB
Conflicting Lanes Right	1	1	1
HCM Control Delay	7.2	7.4	7
HCM LOS	A	A	A

Lane	NBLn1	EBLn1	WBLn1	SBLn1
Vol Left, %	29%	0%	7%	0%
Vol Thru, %	29%	91%	90%	0%
Vol Right, %	43%	9%	2%	100%
Sign Control	Stop	Stop	Stop	Stop
Traffic Vol by Lane	7	22	81	7
LT Vol	2	0	6	0
Through Vol	2	20	73	0
RT Vol	3	2	2	7
Lane Flow Rate	8	24	90	8
Geometry Grp	1	1	1	1
Degree of Util (X)	0.008	0.027	0.099	0.008
Departure Headway (Hd)	3.904	4.042	3.946	3.504
Convergence, Y/N	Yes	Yes	Yes	Yes
Cap	911	887	912	1014
Service Time	1.952	2.062	1.954	1.551
HCM Lane V/C Ratio	0.009	0.027	0.099	0.008
HCM Control Delay	7	7.2	7.4	6.6
HCM Lane LOS	A	A	A	A
HCM 95th-tile Q	0	0.1	0.3	0

Intersection

Intersection Delay, s/veh

Intersection LOS

Movement	SBU	SBL	SBT	SBR
Lane Configurations			↕	
Traffic Vol, veh/h	0	0	0	7
Future Vol, veh/h	0	0	0	7
Peak Hour Factor	0.92	0.90	0.90	0.90
Heavy Vehicles, %	2	0	0	0
Mvmt Flow	0	0	0	8
Number of Lanes	0	0	1	0

Approach SB

Opposing Approach	NB
Opposing Lanes	1
Conflicting Approach Left	WB
Conflicting Lanes Left	1
Conflicting Approach Right	EB
Conflicting Lanes Right	1
HCM Control Delay	6.6
HCM LOS	A

Intersection

Int Delay, s/veh 1.5

Movement	WBL	WBR	NBT	NBR	SBL	SBT
Lane Configurations	↕		↑	↗		↖
Traffic Vol, veh/h	13	6	1044	21	6	1094
Future Vol, veh/h	13	6	1044	21	6	1094
Conflicting Peds, #/hr	0	0	0	1	1	0
Sign Control	Stop	Stop	Free	Free	Free	Free
RT Channelized	-	None	-	None	-	None
Storage Length	0	-	-	125	-	-
Veh in Median Storage, #	0	-	0	-	-	0
Grade, %	0	-	0	-	-	0
Peak Hour Factor	95	95	95	95	95	95
Heavy Vehicles, %	0	0	2	0	0	2
Mvmt Flow	14	6	1099	22	6	1152

Major/Minor	Minor1		Major1		Major2	
Conflicting Flow All	2264	1100	0	0	1100	0
Stage 1	1100	-	-	-	-	-
Stage 2	1164	-	-	-	-	-
Critical Hdwy	7.1	6.2	-	-	4.1	-
Critical Hdwy Stg 1	6.1	-	-	-	-	-
Critical Hdwy Stg 2	6.1	-	-	-	-	-
Follow-up Hdwy	3.5	3.3	-	-	2.2	-
Pot Cap-1 Maneuver	29	260	-	-	642	-
Stage 1	260	-	-	-	-	-
Stage 2	239	-	-	-	-	-
Platoon blocked, %			-	-		
Mov Cap-1 Maneuver	28	260	-	-	642	-
Mov Cap-2 Maneuver	28	-	-	-	-	-
Stage 1	260	-	-	-	-	-
Stage 2	233	-	-	-	-	-

Approach	WB		NB		SB
HCM Control Delay, s	170.2		0		0.1
HCM LOS	F				

Minor Lane/Major Mvmt	NBT	NBRWBLn1	SBL	SBT
Capacity (veh/h)	-	-	39	642
HCM Lane V/C Ratio	-	-	0.513	0.01
HCM Control Delay (s)	-	-	170.2	10.7
HCM Lane LOS	-	-	F	B
HCM 95th %tile Q(veh)	-	-	1.8	0

Intersection

Int Delay, s/veh 0.8

Movement	EBL	EBT	EBR	WBL	WBT	WBR	NBL	NBT	NBR	SBL	SBT	SBR
Lane Configurations		↔			↔		↑	↑		↑	↑	
Traffic Vol, veh/h	6	0	5	2	0	3	0	1053	0	2	1100	5
Future Vol, veh/h	6	0	5	2	0	3	0	1053	0	2	1100	5
Conflicting Peds, #/hr	5	0	0	0	0	5	0	0	4	4	0	0
Sign Control	Stop	Stop	Stop	Stop	Stop	Stop	Free	Free	Free	Free	Free	Free
RT Channelized	-	-	None	-	-	None	-	-	None	-	-	None
Storage Length	-	-	-	-	-	-	65	-	-	50	-	-
Veh in Median Storage, #	-	0	-	-	0	-	-	0	-	-	0	-
Grade, %	-	0	-	-	0	-	-	0	-	-	0	-
Peak Hour Factor	94	94	94	94	94	94	94	94	94	94	94	94
Heavy Vehicles, %	0	0	0	0	0	0	0	2	0	0	1	0
Mvmt Flow	6	0	5	2	0	3	0	1120	0	2	1170	5

Major/Minor	Minor2			Minor1			Major1			Major2		
Conflicting Flow All	2304	2301	1173	2304	2304	1129	1176	0	0	1124	0	0
Stage 1	1177	1177	-	1124	1124	-	-	-	-	-	-	-
Stage 2	1127	1124	-	1180	1180	-	-	-	-	-	-	-
Critical Hdwy	7.1	6.5	6.2	7.1	6.5	6.2	4.1	-	-	4.1	-	-
Critical Hdwy Stg 1	6.1	5.5	-	6.1	5.5	-	-	-	-	-	-	-
Critical Hdwy Stg 2	6.1	5.5	-	6.1	5.5	-	-	-	-	-	-	-
Follow-up Hdwy	3.5	4	3.3	3.5	4	3.3	2.2	-	-	2.2	-	-
Pot Cap-1 Maneuver	27	39	236	27	39	251	601	-	-	629	-	-
Stage 1	235	267	-	252	283	-	-	-	-	-	-	-
Stage 2	251	283	-	234	266	-	-	-	-	-	-	-
Platoon blocked, %												
Mov Cap-1 Maneuver	26	39	236	26	39	249	601	-	-	626	-	-
Mov Cap-2 Maneuver	26	39	-	26	39	-	-	-	-	-	-	-
Stage 1	235	266	-	251	282	-	-	-	-	-	-	-
Stage 2	247	282	-	228	265	-	-	-	-	-	-	-

Approach	EB	WB	NB	SB
HCM Control Delay, s	114.2	75.9	0	0
HCM LOS	F	F		

Minor Lane/Major Mvmt	NBL	NBT	NBR	EBLn1	WBLn1	SBL	SBT	SBR
Capacity (veh/h)	601	-	-	44	56	626	-	-
HCM Lane V/C Ratio	-	-	-	0.266	0.095	0.003	-	-
HCM Control Delay (s)	0	-	-	114.2	75.9	10.8	-	-
HCM Lane LOS	A	-	-	F	F	B	-	-
HCM 95th %tile Q(veh)	0	-	-	0.9	0.3	0	-	-

Intersection

Int Delay, s/veh 0.9

Movement	WBL	WBR	NBT	NBR	SBL	SBT
Lane Configurations	↘↙		↘		↘	↗
Traffic Vol, veh/h	9	13	1035	13	37	1059
Future Vol, veh/h	9	13	1035	13	37	1059
Conflicting Peds, #/hr	0	0	0	2	2	0
Sign Control	Stop	Stop	Free	Free	Free	Free
RT Channelized	-	None	-	None	-	None
Storage Length	0	-	-	-	65	-
Veh in Median Storage, #	0	-	0	-	-	0
Grade, %	0	-	0	-	-	0
Peak Hour Factor	96	96	96	96	96	96
Heavy Vehicles, %	0	0	2	0	0	2
Mvmt Flow	9	14	1078	14	39	1103

Major/Minor	Minor1		Major1		Major2	
Conflicting Flow All	2267	1087	0	0	1094	0
Stage 1	1087	-	-	-	-	-
Stage 2	1180	-	-	-	-	-
Critical Hdwy	6.4	6.2	-	-	4.1	-
Critical Hdwy Stg 1	5.4	-	-	-	-	-
Critical Hdwy Stg 2	5.4	-	-	-	-	-
Follow-up Hdwy	3.5	3.3	-	-	2.2	-
Pot Cap-1 Maneuver	45	265	-	-	645	-
Stage 1	326	-	-	-	-	-
Stage 2	295	-	-	-	-	-
Platoon blocked, %			-	-		-
Mov Cap-1 Maneuver	42	264	-	-	645	-
Mov Cap-2 Maneuver	42	-	-	-	-	-
Stage 1	325	-	-	-	-	-
Stage 2	277	-	-	-	-	-

Approach	WB		NB		SB
HCM Control Delay, s	64.2		0		0.4
HCM LOS	F				

Minor Lane/Major Mvmt	NBT	NBRWBLn1	SBL	SBT
Capacity (veh/h)	-	- 83	645	-
HCM Lane V/C Ratio	-	- 0.276	0.06	-
HCM Control Delay (s)	-	- 64.2	10.9	-
HCM Lane LOS	-	- F	B	-
HCM 95th %tile Q(veh)	-	- 1	0.2	-

Intersection

Int Delay, s/veh 6.2

Movement	WBL	WBR	NBT	NBR	SBL	SBT
Lane Configurations	Y		P			A
Traffic Vol, veh/h	5	7	2	7	22	0
Future Vol, veh/h	5	7	2	7	22	0
Conflicting Peds, #/hr	1	0	0	5	5	0
Sign Control	Stop	Stop	Free	Free	Free	Free
RT Channelized	-	None	-	None	-	None
Storage Length	0	-	-	-	-	-
Veh in Median Storage, #	0	-	0	-	-	0
Grade, %	0	-	0	-	-	0
Peak Hour Factor	75	75	75	75	75	75
Heavy Vehicles, %	0	17	0	0	0	0
Mvmt Flow	7	9	3	9	29	0

Major/Minor	Minor1		Major1		Major2	
Conflicting Flow All	72	12	0	0	17	0
Stage 1	12	-	-	-	-	-
Stage 2	60	-	-	-	-	-
Critical Hdwy	6.4	6.37	-	-	4.1	-
Critical Hdwy Stg 1	5.4	-	-	-	-	-
Critical Hdwy Stg 2	5.4	-	-	-	-	-
Follow-up Hdwy	3.5	3.453	-	-	2.2	-
Pot Cap-1 Maneuver	937	1027	-	-	1613	-
Stage 1	1016	-	-	-	-	-
Stage 2	968	-	-	-	-	-
Platoon blocked, %			-	-		
Mov Cap-1 Maneuver	915	1022	-	-	1613	-
Mov Cap-2 Maneuver	915	-	-	-	-	-
Stage 1	1011	-	-	-	-	-
Stage 2	950	-	-	-	-	-

Approach	WB		NB		SB
HCM Control Delay, s	8.8		0		7.3
HCM LOS	A				

Minor Lane/Major Mvmt	NBT	NBRWBLn1	SBL	SBT
Capacity (veh/h)	-	- 975	1613	-
HCM Lane V/C Ratio	-	- 0.016	0.018	-
HCM Control Delay (s)	-	- 8.8	7.3	0
HCM Lane LOS	-	- A	A	A
HCM 95th %tile Q(veh)	-	- 0.1	0.1	-

Intersection

Int Delay, s/veh 2.1

Movement	EBT	EBR	WBL	WBT	NBL	NBR
Lane Configurations	↔		↔		↔	
Traffic Vol, veh/h	10	19	2	5	9	0
Future Vol, veh/h	10	19	2	5	9	0
Conflicting Peds, #/hr	0	3	3	0	1	0
Sign Control	Free	Free	Free	Free	Stop	Stop
RT Channelized	-	None	-	None	-	None
Storage Length	-	-	-	-	0	-
Veh in Median Storage, #	0	-	-	0	0	-
Grade, %	0	-	-	0	0	-
Peak Hour Factor	69	69	69	69	69	69
Heavy Vehicles, %	0	0	0	0	29	0
Mvmt Flow	14	28	3	7	13	0

Major/Minor	Major1	Major2	Minor1
Conflicting Flow All	0	45	45
Stage 1	-	-	31
Stage 2	-	-	14
Critical Hdwy	-	4.1	6.69
Critical Hdwy Stg 1	-	-	5.69
Critical Hdwy Stg 2	-	-	5.69
Follow-up Hdwy	-	2.2	3.761
Pot Cap-1 Maneuver	-	1576	901
Stage 1	-	-	926
Stage 2	-	-	943
Platoon blocked, %	-	-	-
Mov Cap-1 Maneuver	-	1576	896
Mov Cap-2 Maneuver	-	-	896
Stage 1	-	-	923
Stage 2	-	-	940

Approach	EB	WB	NB
HCM Control Delay, s	0	2.1	9.1
HCM LOS			A

Minor Lane/Major Mvmt	NBLn1	EBT	EBR	WBL	WBT
Capacity (veh/h)	896	-	-	1576	-
HCM Lane V/C Ratio	0.015	-	-	0.002	-
HCM Control Delay (s)	9.1	-	-	7.3	0
HCM Lane LOS	A	-	-	A	A
HCM 95th %tile Q(veh)	0	-	-	0	-

Intersection

Int Delay, s/veh 2.3

Movement	EBL	EBT	EBR	WBL	WBT	WBR	NBL	NBT	NBR	SBL	SBT	SBR
Lane Configurations		↕			↕		↕	↕		↕	↕	
Traffic Vol, veh/h	9	0	9	9	0	20	12	1014	9	33	999	6
Future Vol, veh/h	9	0	9	9	0	20	12	1014	9	33	999	6
Conflicting Peds, #/hr	0	0	0	0	0	0	0	0	2	2	0	0
Sign Control	Stop	Stop	Stop	Stop	Stop	Stop	Free	Free	Free	Free	Free	Free
RT Channelized	-	-	None	-	-	None	-	-	None	-	-	None
Storage Length	-	-	-	-	-	-	125	-	-	125	-	-
Veh in Median Storage, #	-	0	-	-	0	-	-	0	-	-	0	-
Grade, %	-	0	-	-	0	-	-	0	-	-	0	-
Peak Hour Factor	96	96	96	96	96	96	96	96	96	96	96	96
Heavy Vehicles, %	0	0	0	0	0	0	0	2	14	7	2	0
Mvmt Flow	9	0	9	9	0	21	13	1056	9	34	1041	6

Major/Minor	Minor2			Minor1			Major1			Major2		
Conflicting Flow All	2209	2206	1044	2205	2204	1063	1047	0	0	1068	0	0
Stage 1	1113	1113	-	1088	1088	-	-	-	-	-	-	-
Stage 2	1096	1093	-	1117	1116	-	-	-	-	-	-	-
Critical Hdwy	7.1	6.5	6.2	7.1	6.5	6.2	4.1	-	-	4.17	-	-
Critical Hdwy Stg 1	6.1	5.5	-	6.1	5.5	-	-	-	-	-	-	-
Critical Hdwy Stg 2	6.1	5.5	-	6.1	5.5	-	-	-	-	-	-	-
Follow-up Hdwy	3.5	4	3.3	3.5	4	3.3	2.2	-	-	2.263	-	-
Pot Cap-1 Maneuver	32	45	281	32	45	274	672	-	-	634	-	-
Stage 1	255	286	-	264	294	-	-	-	-	-	-	-
Stage 2	261	293	-	254	285	-	-	-	-	-	-	-
Platoon blocked, %												
Mov Cap-1 Maneuver	28	42	281	29	42	273	672	-	-	634	-	-
Mov Cap-2 Maneuver	28	42	-	29	42	-	-	-	-	-	-	-
Stage 1	250	271	-	258	288	-	-	-	-	-	-	-
Stage 2	236	287	-	232	270	-	-	-	-	-	-	-

Approach	EB	WB	NB	SB
HCM Control Delay, s	112	80.7	0.1	0.3
HCM LOS	F	F		

Minor Lane/Major Mvmt	NBL	NBT	NBR	EBLn1WBLn1	SBL	SBT	SBR
Capacity (veh/h)	672	-	-	51	76	634	-
HCM Lane V/C Ratio	0.019	-	-	0.368	0.397	0.054	-
HCM Control Delay (s)	10.5	-	-	112	80.7	11	-
HCM Lane LOS	B	-	-	F	F	B	-
HCM 95th %tile Q(veh)	0.1	-	-	1.3	1.6	0.2	-

Intersection												
Int Delay, s/veh	13.5											
Movement	EBL	EBT	EBR	WBL	WBT	WBR	NBL	NBT	NBR	SBL	SBT	SBR
Lane Configurations		↕			↕		↕	↕		↕	↕	
Traffic Vol, veh/h	4	0	4	37	0	16	10	1052	49	20	981	12
Future Vol, veh/h	4	0	4	37	0	16	10	1052	49	20	981	12
Conflicting Peds, #/hr	0	0	0	0	0	0	1	0	0	0	0	1
Sign Control	Stop	Stop	Stop	Stop	Stop	Stop	Free	Free	Free	Free	Free	Free
RT Channelized	-	-	None	-	-	None	-	-	None	-	-	None
Storage Length	-	-	-	-	-	-	80	-	-	125	-	-
Veh in Median Storage, #	-	0	-	-	0	-	-	0	-	-	0	-
Grade, %	-	0	-	-	0	-	-	0	-	-	0	-
Peak Hour Factor	93	93	93	93	93	93	93	93	93	93	93	93
Heavy Vehicles, %	2	2	2	2	2	2	2	2	2	2	2	2
Mvmt Flow	4	0	4	40	0	17	11	1131	53	22	1055	13

Major/Minor	Minor2		Minor1		Major1		Major2					
Conflicting Flow All	2295	2313	1063	2288	2293	1158	1069	0	0	1184	0	0
Stage 1	1107	1107	-	1180	1180	-	-	-	-	-	-	-
Stage 2	1188	1206	-	1108	1113	-	-	-	-	-	-	-
Critical Hdwy	7.12	6.52	6.22	7.12	6.52	6.22	4.12	-	-	4.12	-	-
Critical Hdwy Stg 1	6.12	5.52	-	6.12	5.52	-	-	-	-	-	-	-
Critical Hdwy Stg 2	6.12	5.52	-	6.12	5.52	-	-	-	-	-	-	-
Follow-up Hdwy	3.518	4.018	3.318	3.518	4.018	3.318	2.218	-	-	2.218	-	-
Pot Cap-1 Maneuver	27	38	271	~28	39	239	652	-	-	590	-	-
Stage 1	255	286	-	232	264	-	-	-	-	-	-	-
Stage 2	230	257	-	255	284	-	-	-	-	-	-	-
Platoon blocked, %								-	-	-	-	-
Mov Cap-1 Maneuver	24	36	271	~26	37	239	651	-	-	590	-	-
Mov Cap-2 Maneuver	24	36	-	~26	37	-	-	-	-	-	-	-
Stage 1	250	275	-	228	260	-	-	-	-	-	-	-
Stage 2	210	253	-	242	273	-	-	-	-	-	-	-

Approach	EB	WB	NB	SB
HCM Control Delay, s	105.7	\$ 533.6	0.1	0.2
HCM LOS	F	F		

Minor Lane/Major Mvmt	NBL	NBT	NBR	EBLn1	WBLn1	SBL	SBT	SBR
Capacity (veh/h)	651	-	-	44	36	590	-	-
HCM Lane V/C Ratio	0.017	-	-	0.196	1.583	0.036	-	-
HCM Control Delay (s)	10.6	-	-	105.7	\$ 533.6	11.3	-	-
HCM Lane LOS	B	-	-	F	F	B	-	-
HCM 95th %tile Q(veh)	0.1	-	-	0.6	6.1	0.1	-	-

Notes
 ~: Volume exceeds capacity \$: Delay exceeds 300s +: Computation Not Defined *: All major volume in platoon

Intersection

Int Delay, s/veh 4

Movement	EBL	EBT	EBR	WBL	WBT	WBR	NBL	NBT	NBR	SBL	SBT	SBR
Lane Configurations		↕			↕			↕			↕	
Traffic Vol, veh/h	16	41	3	0	40	5	11	9	7	4	10	14
Future Vol, veh/h	16	41	3	0	40	5	11	9	7	4	10	14
Conflicting Peds, #/hr	2	0	1	1	0	2	0	0	0	0	0	0
Sign Control	Free	Free	Free	Free	Free	Free	Stop	Stop	Stop	Stop	Stop	Stop
RT Channelized	-	-	None	-	-	None	-	-	None	-	-	None
Storage Length	-	-	-	-	-	-	-	-	-	-	-	-
Veh in Median Storage, #	-	0	-	-	0	-	-	0	-	-	0	-
Grade, %	-	0	-	-	0	-	-	0	-	-	0	-
Peak Hour Factor	79	79	79	79	79	79	79	79	79	79	79	79
Heavy Vehicles, %	0	3	0	0	0	0	0	0	0	33	0	0
Mvmt Flow	20	52	4	0	51	6	14	11	9	5	13	18

Major/Minor	Major1			Major2			Minor1			Minor2		
Conflicting Flow All	59	0	0	57	0	0	164	154	55	160	153	56
Stage 1	-	-	-	-	-	-	95	95	-	56	56	-
Stage 2	-	-	-	-	-	-	69	59	-	104	97	-
Critical Hdwy	4.1	-	-	4.1	-	-	7.1	6.5	6.2	7.43	6.5	6.2
Critical Hdwy Stg 1	-	-	-	-	-	-	6.1	5.5	-	6.43	5.5	-
Critical Hdwy Stg 2	-	-	-	-	-	-	6.1	5.5	-	6.43	5.5	-
Follow-up Hdwy	2.2	-	-	2.2	-	-	3.5	4	3.3	3.797	4	3.3
Pot Cap-1 Maneuver	1558	-	-	1560	-	-	805	741	1018	741	742	1016
Stage 1	-	-	-	-	-	-	917	820	-	883	852	-
Stage 2	-	-	-	-	-	-	946	850	-	831	819	-
Platoon blocked, %	-	-	-	-	-	-	-	-	-	-	-	-
Mov Cap-1 Maneuver	1558	-	-	1560	-	-	772	729	1017	717	730	1014
Mov Cap-2 Maneuver	-	-	-	-	-	-	772	729	-	717	730	-
Stage 1	-	-	-	-	-	-	904	809	-	870	850	-
Stage 2	-	-	-	-	-	-	916	848	-	802	808	-

Approach	EB	WB	NB	SB
HCM Control Delay, s	2	0	9.7	9.4
HCM LOS			A	A

Minor Lane/Major Mvmt	NBLn1	EBL	EBT	EBR	WBL	WBT	WBR	SBLn1
Capacity (veh/h)	807	1558	-	-	1560	-	-	846
HCM Lane V/C Ratio	0.042	0.013	-	-	-	-	-	0.042
HCM Control Delay (s)	9.7	7.3	0	-	0	-	-	9.4
HCM Lane LOS	A	A	A	-	A	-	-	A
HCM 95th %tile Q(veh)	0.1	0	-	-	0	-	-	0.1

Intersection

Int Delay, s/veh 7.6

Movement	EBL	EBT	EBR	WBL	WBT	WBR	NBL	NBT	NBR	SBL	SBT	SBR
Lane Configurations		↕			↕			↕			↕	
Traffic Vol, veh/h	0	46	4	11	39	3	5	7	6	18	14	3
Future Vol, veh/h	0	46	4	11	39	3	5	7	6	18	14	3
Conflicting Peds, #/hr	3	0	0	0	0	3	3	0	2	2	0	3
Sign Control	Stop	Stop	Stop	Stop	Stop	Stop	Free	Free	Free	Free	Free	Free
RT Channelized	-	-	None	-	-	None	-	-	None	-	-	None
Storage Length	-	-	-	-	-	-	-	-	-	-	-	-
Veh in Median Storage, #	-	0	-	-	0	-	-	0	-	-	0	-
Grade, %	-	0	-	-	0	-	-	0	-	-	0	-
Peak Hour Factor	86	86	86	86	86	86	86	86	86	86	86	86
Heavy Vehicles, %	0	5	0	22	0	0	0	0	0	0	8	0
Mvmt Flow	0	53	5	13	45	3	6	8	7	21	16	3

Major/Minor	Minor2			Minor1			Major1			Major2		
Conflicting Flow All	114	92	21	114	90	17	23	0	0	17	0	0
Stage 1	63	63	-	25	25	-	-	-	-	-	-	-
Stage 2	51	29	-	89	65	-	-	-	-	-	-	-
Critical Hdwy	7.1	6.55	6.2	7.32	6.5	6.2	4.1	-	-	4.1	-	-
Critical Hdwy Stg 1	6.1	5.55	-	6.32	5.5	-	-	-	-	-	-	-
Critical Hdwy Stg 2	6.1	5.55	-	6.32	5.5	-	-	-	-	-	-	-
Follow-up Hdwy	3.5	4.045	3.3	3.698	4	3.3	2.2	-	-	2.2	-	-
Pot Cap-1 Maneuver	868	792	1062	818	804	1068	1605	-	-	1613	-	-
Stage 1	953	837	-	944	878	-	-	-	-	-	-	-
Stage 2	967	865	-	871	845	-	-	-	-	-	-	-
Platoon blocked, %												
Mov Cap-1 Maneuver	812	775	1059	760	787	1063	1605	-	-	1608	-	-
Mov Cap-2 Maneuver	812	775	-	760	787	-	-	-	-	-	-	-
Stage 1	946	824	-	938	873	-	-	-	-	-	-	-
Stage 2	908	860	-	800	832	-	-	-	-	-	-	-

Approach	EB	WB	NB	SB
HCM Control Delay, s	9.9	9.9	2	3.7
HCM LOS	A	A		

Minor Lane/Major Mvmt	NBL	NBT	NBR	EBLn1WBLn1	SBL	SBT	SBR
Capacity (veh/h)	1605	-	-	792 793	1608	-	-
HCM Lane V/C Ratio	0.004	-	-	0.073 0.078 0.013		-	-
HCM Control Delay (s)	7.3	0	-	9.9 9.9 7.3	0	-	-
HCM Lane LOS	A	A	-	A A A	A	-	-
HCM 95th %tile Q(veh)	0	-	-	0.2 0.3 0	-	-	-

Intersection	
Intersection Delay, s/veh	7.4
Intersection LOS	A

Movement	EBU	EBL	EBT	EBR	WBU	WBL	WBT	WBR	NBU	NBL	NBT	NBR
Lane Configurations			↕				↕				↕	
Traffic Vol, veh/h	0	3	62	7	0	2	37	0	0	6	3	4
Future Vol, veh/h	0	3	62	7	0	2	37	0	0	6	3	4
Peak Hour Factor	0.92	0.75	0.75	0.75	0.92	0.75	0.75	0.75	0.92	0.75	0.75	0.75
Heavy Vehicles, %	2	0	4	0	2	0	0	0	2	40	0	0
Mvmt Flow	0	4	83	9	0	3	49	0	0	8	4	5
Number of Lanes	0	0	1	0	0	0	1	0	0	0	1	0

Approach	EB	WB	NB
Opposing Approach	WB	EB	SB
Opposing Lanes	1	1	1
Conflicting Approach Left	SB	NB	EB
Conflicting Lanes Left	1	1	1
Conflicting Approach Right	NB	SB	WB
Conflicting Lanes Right	1	1	1
HCM Control Delay	7.4	7.3	7.9
HCM LOS	A	A	A

Lane	NBLn1	EBLn1	WBLn1	SBLn1
Vol Left, %	46%	4%	5%	0%
Vol Thru, %	23%	86%	95%	0%
Vol Right, %	31%	10%	0%	100%
Sign Control	Stop	Stop	Stop	Stop
Traffic Vol by Lane	13	72	39	5
LT Vol	6	3	2	0
Through Vol	3	62	37	0
RT Vol	4	7	0	5
Lane Flow Rate	17	96	52	7
Geometry Grp	1	1	1	1
Degree of Util (X)	0.023	0.105	0.058	0.007
Departure Headway (Hd)	4.748	3.93	4.023	3.566
Convergence, Y/N	Yes	Yes	Yes	Yes
Cap	749	911	888	991
Service Time	2.811	1.958	2.058	1.634
HCM Lane V/C Ratio	0.023	0.105	0.059	0.007
HCM Control Delay	7.9	7.4	7.3	6.7
HCM Lane LOS	A	A	A	A
HCM 95th-tile Q	0.1	0.4	0.2	0

Intersection				
Intersection Delay, s/veh				
Intersection LOS				
Movement	SBU	SBL	SBT	SBR
Lane Configurations			↕	
Traffic Vol, veh/h	0	0	0	5
Future Vol, veh/h	0	0	0	5
Peak Hour Factor	0.92	0.75	0.75	0.75
Heavy Vehicles, %	2	0	0	0
Mvmt Flow	0	0	0	7
Number of Lanes	0	0	1	0
Approach			SB	
Opposing Approach			NB	
Opposing Lanes			1	
Conflicting Approach Left			WB	
Conflicting Lanes Left			1	
Conflicting Approach Right			EB	
Conflicting Lanes Right			1	
HCM Control Delay			6.7	
HCM LOS			A	

Intersection

Int Delay, s/veh 0.4

Movement	WBL	WBR	NBT	NBR	SBL	SBT
Lane Configurations	↘		↑	↗		↖
Traffic Vol, veh/h	9	4	1016	11	5	968
Future Vol, veh/h	9	4	1016	11	5	968
Conflicting Peds, #/hr	0	0	0	1	1	0
Sign Control	Stop	Stop	Free	Free	Free	Free
RT Channelized	-	None	-	None	-	None
Storage Length	0	-	-	125	-	-
Veh in Median Storage, #	0	-	0	-	-	0
Grade, %	0	-	0	-	-	0
Peak Hour Factor	96	96	96	96	96	96
Heavy Vehicles, %	0	0	2	0	0	1
Mvmt Flow	9	4	1058	11	5	1008

Major/Minor	Minor1		Major1		Major2	
Conflicting Flow All	2078	1059	0	0	1059	0
Stage 1	1059	-	-	-	-	-
Stage 2	1019	-	-	-	-	-
Critical Hdwy	6.4	6.2	-	-	4.1	-
Critical Hdwy Stg 1	5.4	-	-	-	-	-
Critical Hdwy Stg 2	5.4	-	-	-	-	-
Follow-up Hdwy	3.5	3.3	-	-	2.2	-
Pot Cap-1 Maneuver	60	275	-	-	665	-
Stage 1	336	-	-	-	-	-
Stage 2	351	-	-	-	-	-
Platoon blocked, %			-	-		-
Mov Cap-1 Maneuver	59	275	-	-	665	-
Mov Cap-2 Maneuver	59	-	-	-	-	-
Stage 1	336	-	-	-	-	-
Stage 2	345	-	-	-	-	-

Approach	WB		NB		SB
HCM Control Delay, s	60.6		0		0.1
HCM LOS	F				

Minor Lane/Major Mvmt	NBT	NBRWBLn1	SBL	SBT
Capacity (veh/h)	-	-	78	665
HCM Lane V/C Ratio	-	-	0.174	0.008
HCM Control Delay (s)	-	-	60.6	10.5
HCM Lane LOS	-	-	F	B
HCM 95th %tile Q(veh)	-	-	0.6	0

Intersection

Int Delay, s/veh 0.1

Movement	EBL	EBT	EBR	WBL	WBT	WBR	NBL	NBT	NBR	SBL	SBT	SBR
Lane Configurations		↔			↔		↑	↑		↑	↑	
Traffic Vol, veh/h	0	0	0	2	0	2	3	1013	0	2	977	5
Future Vol, veh/h	0	0	0	2	0	2	3	1013	0	2	977	5
Conflicting Peds, #/hr	0	0	1	1	0	0	0	0	3	3	0	0
Sign Control	Stop	Stop	Stop	Stop	Stop	Stop	Free	Free	Free	Free	Free	Free
RT Channelized	-	-	None	-	-	None	-	-	None	-	-	None
Storage Length	-	-	-	-	-	-	65	-	-	50	-	-
Veh in Median Storage, #	-	0	-	-	0	-	-	0	-	-	0	-
Grade, %	-	0	-	-	0	-	-	0	-	-	0	-
Peak Hour Factor	96	96	96	96	96	96	96	96	96	96	96	96
Heavy Vehicles, %	0	0	0	0	0	0	0	3	0	0	2	0
Mvmt Flow	0	0	0	2	0	2	3	1055	0	2	1018	5

Major/Minor	Minor2			Minor1			Major1			Major2		
Conflicting Flow All	2087	2088	1021	2089	2091	1058	1023	0	0	1058	0	0
Stage 1	1024	1024	-	1064	1064	-	-	-	-	-	-	-
Stage 2	1063	1064	-	1025	1027	-	-	-	-	-	-	-
Critical Hdwy	7.1	6.5	6.2	7.1	6.5	6.2	4.1	-	-	4.1	-	-
Critical Hdwy Stg 1	6.1	5.5	-	6.1	5.5	-	-	-	-	-	-	-
Critical Hdwy Stg 2	6.1	5.5	-	6.1	5.5	-	-	-	-	-	-	-
Follow-up Hdwy	3.5	4	3.3	3.5	4	3.3	2.2	-	-	2.2	-	-
Pot Cap-1 Maneuver	39	53	289	39	53	276	686	-	-	666	-	-
Stage 1	286	315	-	272	302	-	-	-	-	-	-	-
Stage 2	272	302	-	286	314	-	-	-	-	-	-	-
Platoon blocked, %												
Mov Cap-1 Maneuver	38	52	289	39	52	275	685	-	-	666	-	-
Mov Cap-2 Maneuver	38	52	-	39	52	-	-	-	-	-	-	-
Stage 1	285	314	-	270	300	-	-	-	-	-	-	-
Stage 2	269	300	-	285	313	-	-	-	-	-	-	-

Approach	EB	WB	NB	SB
HCM Control Delay, s	0	61.4	0	0
HCM LOS	A	F		

Minor Lane/Major Mvmt	NBL	NBT	NBR	EBLn1WBLn1	SBL	SBT	SBR
Capacity (veh/h)	685	-	-	-	68	666	-
HCM Lane V/C Ratio	0.005	-	-	-	0.061	0.003	-
HCM Control Delay (s)	10.3	-	-	0	61.4	10.4	-
HCM Lane LOS	B	-	-	A	F	B	-
HCM 95th %tile Q(veh)	0	-	-	-	0.2	0	-

Intersection

Int Delay, s/veh 0.9

Movement	WBL	WBR	NBT	NBR	SBL	SBT
Lane Configurations	↘↙		↘		↘	↗
Traffic Vol, veh/h	10	21	987	8	21	958
Future Vol, veh/h	10	21	987	8	21	958
Conflicting Peds, #/hr	0	0	0	1	1	0
Sign Control	Stop	Stop	Free	Free	Free	Free
RT Channelized	-	None	-	None	-	None
Storage Length	0	-	-	-	65	-
Veh in Median Storage, #	0	-	0	-	-	0
Grade, %	0	-	0	-	-	0
Peak Hour Factor	93	93	93	93	93	93
Heavy Vehicles, %	0	9	2	0	0	1
Mvmt Flow	11	23	1061	9	23	1030

Major/Minor	Minor1		Major1		Major2	
Conflicting Flow All	2142	1067	0	0	1071	0
Stage 1	1067	-	-	-	-	-
Stage 2	1075	-	-	-	-	-
Critical Hdwy	6.4	6.29	-	-	4.1	-
Critical Hdwy Stg 1	5.4	-	-	-	-	-
Critical Hdwy Stg 2	5.4	-	-	-	-	-
Follow-up Hdwy	3.5	3.381	-	-	2.2	-
Pot Cap-1 Maneuver	54	261	-	-	658	-
Stage 1	334	-	-	-	-	-
Stage 2	331	-	-	-	-	-
Platoon blocked, %			-	-		
Mov Cap-1 Maneuver	52	261	-	-	658	-
Mov Cap-2 Maneuver	52	-	-	-	-	-
Stage 1	334	-	-	-	-	-
Stage 2	319	-	-	-	-	-

Approach	WB		NB		SB
HCM Control Delay, s	49.1		0		0.2
HCM LOS	E				

Minor Lane/Major Mvmt	NBT	NBRWBLn1	SBL	SBT
Capacity (veh/h)	-	- 114	658	-
HCM Lane V/C Ratio	-	- 0.292	0.034	-
HCM Control Delay (s)	-	- 49.1	10.7	-
HCM Lane LOS	-	- E	B	-
HCM 95th %tile Q(veh)	-	- 1.1	0.1	-

Intersection						
Int Delay, s/veh	6.4					
Movement	WBL	WBR	NBT	NBR	SBL	SBT
Lane Configurations	Y		P			A
Traffic Vol, veh/h	4	16	2	3	7	3
Future Vol, veh/h	4	16	2	3	7	3
Conflicting Peds, #/hr	2	0	0	0	0	0
Sign Control	Stop	Stop	Free	Free	Free	Free
RT Channelized	-	None	-	None	-	None
Storage Length	0	-	-	-	-	-
Veh in Median Storage, #	0	-	0	-	-	0
Grade, %	0	-	0	-	-	0
Peak Hour Factor	75	75	75	75	75	75
Heavy Vehicles, %	33	8	0	0	0	0
Mvmt Flow	5	21	3	4	9	4
Major/Minor	Minor1		Major1		Major2	
Conflicting Flow All	30	5	0	0	7	0
Stage 1	5	-	-	-	-	-
Stage 2	25	-	-	-	-	-
Critical Hdwy	6.73	6.28	-	-	4.1	-
Critical Hdwy Stg 1	5.73	-	-	-	-	-
Critical Hdwy Stg 2	5.73	-	-	-	-	-
Follow-up Hdwy	3.797	3.372	-	-	2.2	-
Pot Cap-1 Maneuver	911	1061	-	-	1627	-
Stage 1	943	-	-	-	-	-
Stage 2	923	-	-	-	-	-
Platoon blocked, %			-	-		-
Mov Cap-1 Maneuver	904	1061	-	-	1627	-
Mov Cap-2 Maneuver	904	-	-	-	-	-
Stage 1	943	-	-	-	-	-
Stage 2	916	-	-	-	-	-
Approach	WB		NB		SB	
HCM Control Delay, s	8.6		0		5.1	
HCM LOS	A					
Minor Lane/Major Mvmt	NBT	NBRWBLn1	SBL	SBT		
Capacity (veh/h)	-	- 1025	1627	-		
HCM Lane V/C Ratio	-	- 0.026	0.006	-		
HCM Control Delay (s)	-	- 8.6	7.2	0		
HCM Lane LOS	-	- A	A	A		
HCM 95th %tile Q(veh)	-	- 0.1	0	-		

Intersection						
Int Delay, s/veh	6					
Movement	EBT	EBR	WBL	WBT	NBL	NBR
Lane Configurations	↔		↔		↔	
Traffic Vol, veh/h	3	6	2	0	16	2
Future Vol, veh/h	3	6	2	0	16	2
Conflicting Peds, #/hr	0	1	1	0	0	0
Sign Control	Free	Free	Free	Free	Stop	Stop
RT Channelized	-	None	-	None	-	None
Storage Length	-	-	-	-	0	-
Veh in Median Storage, #	0	-	-	0	0	-
Grade, %	0	-	-	0	0	-
Peak Hour Factor	79	79	79	79	79	79
Heavy Vehicles, %	0	0	100	0	15	0
Mvmt Flow	4	8	3	0	20	3
Major/Minor	Major1		Major2		Minor1	
Conflicting Flow All	0	0	12	0	14	9
Stage 1	-	-	-	-	9	-
Stage 2	-	-	-	-	5	-
Critical Hdwy	-	-	5.1	-	6.55	6.2
Critical Hdwy Stg 1	-	-	-	-	5.55	-
Critical Hdwy Stg 2	-	-	-	-	5.55	-
Follow-up Hdwy	-	-	3.1	-	3.635	3.3
Pot Cap-1 Maneuver	-	-	1148	-	972	1079
Stage 1	-	-	-	-	981	-
Stage 2	-	-	-	-	985	-
Platoon blocked, %	-	-	-	-	-	-
Mov Cap-1 Maneuver	-	-	1148	-	968	1078
Mov Cap-2 Maneuver	-	-	-	-	968	-
Stage 1	-	-	-	-	980	-
Stage 2	-	-	-	-	982	-
Approach	EB		WB		NB	
HCM Control Delay, s	0		8.1		8.8	
HCM LOS					A	
Minor Lane/Major Mvmt	NBLn1	EBT	EBR	WBL	WBT	
Capacity (veh/h)	979	-	-	1148	-	
HCM Lane V/C Ratio	0.023	-	-	0.002	-	
HCM Control Delay (s)	8.8	-	-	8.1	0	
HCM Lane LOS	A	-	-	A	A	
HCM 95th %tile Q(veh)	0.1	-	-	0	-	

Intersection

Int Delay, s/veh 1.1

Movement	EBL	EBT	EBR	WBL	WBT	WBR	NBL	NBT	NBR	SBL	SBT	SBR
Lane Configurations		↔			↔		↑	↑		↑	↑	
Traffic Vol, veh/h	0	0	7	7	2	29	11	721	3	26	938	6
Future Vol, veh/h	0	0	7	7	2	29	11	721	3	26	938	6
Conflicting Peds, #/hr	0	0	0	0	0	0	0	0	1	1	0	0
Sign Control	Stop	Stop	Stop	Stop	Stop	Stop	Free	Free	Free	Free	Free	Free
RT Channelized	-	-	None	-	-	None	-	-	None	-	-	None
Storage Length	-	-	-	-	-	-	125	-	-	125	-	-
Veh in Median Storage, #	-	0	-	-	0	-	-	0	-	-	0	-
Grade, %	-	0	-	-	0	-	-	0	-	-	0	-
Peak Hour Factor	95	95	95	95	95	95	95	95	95	95	95	95
Heavy Vehicles, %	0	0	0	17	0	4	0	3	0	5	1	0
Mvmt Flow	0	0	7	7	2	31	12	759	3	27	987	6

Major/Minor	Minor2			Minor1			Major1			Major2		
Conflicting Flow All	1845	1831	991	1834	1833	762	994	0	0	763	0	0
Stage 1	1045	1045	-	785	785	-	-	-	-	-	-	-
Stage 2	800	786	-	1049	1048	-	-	-	-	-	-	-
Critical Hdwy	7.1	6.5	6.2	7.27	6.5	6.24	4.1	-	-	4.15	-	-
Critical Hdwy Stg 1	6.1	5.5	-	6.27	5.5	-	-	-	-	-	-	-
Critical Hdwy Stg 2	6.1	5.5	-	6.27	5.5	-	-	-	-	-	-	-
Follow-up Hdwy	3.5	4	3.3	3.653	4	3.336	2.2	-	-	2.245	-	-
Pot Cap-1 Maneuver	58	77	301	53	77	402	704	-	-	836	-	-
Stage 1	279	308	-	364	407	-	-	-	-	-	-	-
Stage 2	382	406	-	258	307	-	-	-	-	-	-	-
Platoon blocked, %												
Mov Cap-1 Maneuver	50	73	301	50	73	402	704	-	-	836	-	-
Mov Cap-2 Maneuver	50	73	-	50	73	-	-	-	-	-	-	-
Stage 1	274	298	-	357	400	-	-	-	-	-	-	-
Stage 2	345	399	-	244	297	-	-	-	-	-	-	-

Approach	EB	WB	NB	SB
HCM Control Delay, s	17.3	35.1	0.2	0.3
HCM LOS	C	E		

Minor Lane/Major Mvmt	NBL	NBT	NBR	EBLn1WBLn1	SBL	SBT	SBR
Capacity (veh/h)	704	-	-	301	159	836	-
HCM Lane V/C Ratio	0.016	-	-	0.024	0.252	0.033	-
HCM Control Delay (s)	10.2	-	-	17.3	35.1	9.5	-
HCM Lane LOS	B	-	-	C	E	A	-
HCM 95th %tile Q(veh)	0.1	-	-	0.1	0.9	0.1	-

Intersection												
Int Delay, s/veh	4.6											
Movement	EBL	EBT	EBR	WBL	WBT	WBR	NBL	NBT	NBR	SBL	SBT	SBR
Lane Configurations		↔			↔		↔	↔		↔	↔	
Traffic Vol, veh/h	7	4	25	27	4	0	33	705	42	9	938	9
Future Vol, veh/h	7	4	25	27	4	0	33	705	42	9	938	9
Conflicting Peds, #/hr	0	0	0	0	0	0	1	0	0	0	0	1
Sign Control	Stop	Stop	Stop	Stop	Stop	Stop	Free	Free	Free	Free	Free	Free
RT Channelized	-	-	None	-	-	None	-	-	None	-	-	None
Storage Length	-	-	-	-	-	-	80	-	-	125	-	-
Veh in Median Storage, #	-	0	-	-	0	-	-	0	-	-	0	-
Grade, %	-	0	-	-	0	-	-	0	-	-	0	-
Peak Hour Factor	93	93	93	93	93	93	93	93	93	93	93	93
Heavy Vehicles, %	2	2	2	2	2	2	2	2	2	2	2	2
Mvmt Flow	8	4	27	29	4	0	35	758	45	10	1009	10

Major/Minor	Minor2		Minor1		Major1		Major2					
Conflicting Flow All	1888	1908	1015	1901	1891	781	1020	0	0	803	0	0
Stage 1	1035	1035	-	851	851	-	-	-	-	-	-	-
Stage 2	853	873	-	1050	1040	-	-	-	-	-	-	-
Critical Hdwy	7.12	6.52	6.22	7.12	6.52	6.22	4.12	-	-	4.12	-	-
Critical Hdwy Stg 1	6.12	5.52	-	6.12	5.52	-	-	-	-	-	-	-
Critical Hdwy Stg 2	6.12	5.52	-	6.12	5.52	-	-	-	-	-	-	-
Follow-up Hdwy	3.518	4.018	3.318	3.518	4.018	3.318	2.218	-	-	2.218	-	-
Pot Cap-1 Maneuver	54	68	289	52	70	395	680	-	-	821	-	-
Stage 1	280	309	-	355	376	-	-	-	-	-	-	-
Stage 2	354	368	-	275	307	-	-	-	-	-	-	-
Platoon blocked, %								-	-	-	-	-
Mov Cap-1 Maneuver	49	64	289	43	66	395	679	-	-	821	-	-
Mov Cap-2 Maneuver	49	64	-	43	66	-	-	-	-	-	-	-
Stage 1	265	305	-	337	356	-	-	-	-	-	-	-
Stage 2	332	349	-	243	303	-	-	-	-	-	-	-

Approach	EB		WB		NB		SB	
HCM Control Delay, s	47.2		200.1		0.4		0.1	
HCM LOS	E		F					

Minor Lane/Major Mvmt	NBL	NBT	NBR	EBLn1	WBLn1	SBL	SBT	SBR
Capacity (veh/h)	679	-	-	123	45	821	-	-
HCM Lane V/C Ratio	0.052	-	-	0.315	0.741	0.012	-	-
HCM Control Delay (s)	10.6	-	-	47.2	200.1	9.4	-	-
HCM Lane LOS	B	-	-	E	F	A	-	-
HCM 95th %tile Q(veh)	0.2	-	-	1.2	2.9	0	-	-

Intersection

Int Delay, s/veh 4.6

Movement	EBL	EBT	EBR	WBL	WBT	WBR	NBL	NBT	NBR	SBL	SBT	SBR
Lane Configurations		↕			↕			↕			↕	
Traffic Vol, veh/h	29	39	3	6	36	20	12	11	4	7	20	10
Future Vol, veh/h	29	39	3	6	36	20	12	11	4	7	20	10
Conflicting Peds, #/hr	1	0	0	0	0	1	0	0	2	2	0	0
Sign Control	Free	Free	Free	Free	Free	Free	Stop	Stop	Stop	Stop	Stop	Stop
RT Channelized	-	-	None	-	-	None	-	-	None	-	-	None
Storage Length	-	-	-	-	-	-	-	-	-	-	-	-
Veh in Median Storage, #	-	0	-	-	0	-	-	0	-	-	0	-
Grade, %	-	0	-	-	0	-	-	0	-	-	0	-
Peak Hour Factor	83	83	83	83	83	83	83	83	83	83	83	83
Heavy Vehicles, %	0	0	0	0	0	0	0	0	0	0	0	0
Mvmt Flow	35	47	4	7	43	24	14	13	5	8	24	12

Major/Minor	Major1			Major2			Minor1			Minor2		
Conflicting Flow All	68	0	0	51	0	0	207	202	51	201	191	56
Stage 1	-	-	-	-	-	-	119	119	-	71	71	-
Stage 2	-	-	-	-	-	-	88	83	-	130	120	-
Critical Hdwy	4.1	-	-	4.1	-	-	7.1	6.5	6.2	7.1	6.5	6.2
Critical Hdwy Stg 1	-	-	-	-	-	-	6.1	5.5	-	6.1	5.5	-
Critical Hdwy Stg 2	-	-	-	-	-	-	6.1	5.5	-	6.1	5.5	-
Follow-up Hdwy	2.2	-	-	2.2	-	-	3.5	4	3.3	3.5	4	3.3
Pot Cap-1 Maneuver	1546	-	-	1568	-	-	755	698	1023	762	708	1016
Stage 1	-	-	-	-	-	-	890	801	-	944	840	-
Stage 2	-	-	-	-	-	-	925	830	-	878	800	-
Platoon blocked, %		-	-		-	-						
Mov Cap-1 Maneuver	1546	-	-	1565	-	-	711	678	1021	729	688	1015
Mov Cap-2 Maneuver	-	-	-	-	-	-	711	678	-	729	688	-
Stage 1	-	-	-	-	-	-	870	783	-	921	835	-
Stage 2	-	-	-	-	-	-	883	825	-	838	782	-

Approach	EB	WB	NB	SB
HCM Control Delay, s	3	0.7	10.2	10
HCM LOS			B	B

Minor Lane/Major Mvmt	NBLn1	EBL	EBT	EBR	WBL	WBT	WBR	SBLn1
Capacity (veh/h)	729	1546	-	-	1565	-	-	763
HCM Lane V/C Ratio	0.045	0.023	-	-	0.005	-	-	0.058
HCM Control Delay (s)	10.2	7.4	0	-	7.3	0	-	10
HCM Lane LOS	B	A	A	-	A	A	-	B
HCM 95th %tile Q(veh)	0.1	0.1	-	-	0	-	-	0.2

Intersection

Int Delay, s/veh 6.9

Movement	EBL	EBT	EBR	WBL	WBT	WBR	NBL	NBT	NBR	SBL	SBT	SBR
Lane Configurations		↕			↕			↕			↕	
Traffic Vol, veh/h	3	43	4	12	43	3	9	16	9	10	19	4
Future Vol, veh/h	3	43	4	12	43	3	9	16	9	10	19	4
Conflicting Peds, #/hr	4	0	0	0	0	4	1	0	1	1	0	1
Sign Control	Stop	Stop	Stop	Stop	Stop	Stop	Free	Free	Free	Free	Free	Free
RT Channelized	-	-	None	-	-	None	-	-	None	-	-	None
Storage Length	-	-	-	-	-	-	-	-	-	-	-	-
Veh in Median Storage, #	-	0	-	-	0	-	-	0	-	-	0	-
Grade, %	-	0	-	-	0	-	-	0	-	-	0	-
Peak Hour Factor	84	84	84	84	84	84	84	84	84	84	84	84
Heavy Vehicles, %	0	0	0	0	0	0	0	8	14	0	6	0
Mvmt Flow	4	51	5	14	51	4	11	19	11	12	23	5

Major/Minor	Minor2			Minor1			Major1			Major2		
Conflicting Flow All	127	102	26	124	99	29	28	0	0	31	0	0
Stage 1	50	50	-	47	47	-	-	-	-	-	-	-
Stage 2	77	52	-	77	52	-	-	-	-	-	-	-
Critical Hdwy	7.1	6.5	6.2	7.1	6.5	6.2	4.1	-	-	4.1	-	-
Critical Hdwy Stg 1	6.1	5.5	-	6.1	5.5	-	-	-	-	-	-	-
Critical Hdwy Stg 2	6.1	5.5	-	6.1	5.5	-	-	-	-	-	-	-
Follow-up Hdwy	3.5	4	3.3	3.5	4	3.3	2.2	-	-	2.2	-	-
Pot Cap-1 Maneuver	851	792	1056	855	795	1052	1599	-	-	1595	-	-
Stage 1	968	857	-	972	860	-	-	-	-	-	-	-
Stage 2	937	856	-	937	856	-	-	-	-	-	-	-
Platoon blocked, %												
Mov Cap-1 Maneuver	793	779	1055	799	782	1047	1599	-	-	1589	-	-
Mov Cap-2 Maneuver	793	779	-	799	782	-	-	-	-	-	-	-
Stage 1	960	849	-	964	853	-	-	-	-	-	-	-
Stage 2	868	849	-	870	848	-	-	-	-	-	-	-

Approach	EB	WB	NB	SB
HCM Control Delay, s	9.9	10	1.9	2.2
HCM LOS	A	B		

Minor Lane/Major Mvmt	NBL	NBT	NBR	EBLn1WBLn1	SBL	SBT	SBR
Capacity (veh/h)	1599	-	-	797	796	1589	-
HCM Lane V/C Ratio	0.007	-	-	0.075	0.087	0.007	-
HCM Control Delay (s)	7.3	0	-	9.9	10	7.3	0
HCM Lane LOS	A	A	-	A	B	A	A
HCM 95th %tile Q(veh)	0	-	-	0.2	0.3	0	-

Intersection	
Intersection Delay, s/veh	7.2
Intersection LOS	A

Movement	EBU	EBL	EBT	EBR	WBU	WBL	WBT	WBR	NBU	NBL	NBT	NBR
Lane Configurations			↕				↕				↕	
Traffic Vol, veh/h	0	5	52	4	0	3	47	0	0	5	2	5
Future Vol, veh/h	0	5	52	4	0	3	47	0	0	5	2	5
Peak Hour Factor	0.92	0.83	0.83	0.83	0.92	0.83	0.83	0.83	0.92	0.83	0.83	0.83
Heavy Vehicles, %	2	0	2	0	2	0	0	0	2	0	0	0
Mvmt Flow	0	6	63	5	0	4	57	0	0	6	2	6
Number of Lanes	0	0	1	0	0	0	1	0	0	0	1	0

Approach	EB	WB	NB
Opposing Approach	WB	EB	SB
Opposing Lanes	1	1	1
Conflicting Approach Left	SB	NB	EB
Conflicting Lanes Left	1	1	1
Conflicting Approach Right	NB	SB	WB
Conflicting Lanes Right	1	1	1
HCM Control Delay	7.3	7.3	7.1
HCM LOS	A	A	A

Lane	NBLn1	EBLn1	WBLn1	SBLn1
Vol Left, %	42%	8%	6%	0%
Vol Thru, %	17%	85%	94%	22%
Vol Right, %	42%	7%	0%	78%
Sign Control	Stop	Stop	Stop	Stop
Traffic Vol by Lane	12	61	50	9
LT Vol	5	5	3	0
Through Vol	2	52	47	2
RT Vol	5	4	0	7
Lane Flow Rate	14	73	60	11
Geometry Grp	1	1	1	1
Degree of Util (X)	0.016	0.081	0.067	0.011
Departure Headway (Hd)	3.973	3.968	4.012	3.675
Convergence, Y/N	Yes	Yes	Yes	Yes
Cap	894	904	893	965
Service Time	2.029	1.986	2.033	1.733
HCM Lane V/C Ratio	0.016	0.081	0.067	0.011
HCM Control Delay	7.1	7.3	7.3	6.8
HCM Lane LOS	A	A	A	A
HCM 95th-tile Q	0	0.3	0.2	0

Intersection

Intersection Delay, s/veh
 Intersection LOS

Movement	SBU	SBL	SBT	SBR
Lane Configurations			↕	
Traffic Vol, veh/h	0	0	2	7
Future Vol, veh/h	0	0	2	7
Peak Hour Factor	0.92	0.83	0.83	0.83
Heavy Vehicles, %	2	0	0	0
Mvmt Flow	0	0	2	8
Number of Lanes	0	0	1	0

Approach SB

Opposing Approach	NB
Opposing Lanes	1
Conflicting Approach Left	WB
Conflicting Lanes Left	1
Conflicting Approach Right	EB
Conflicting Lanes Right	1
HCM Control Delay	6.8
HCM LOS	A

APPENDIX 9. TDM PLAN

100-499 ADT; ~20-49 Units

About this Form

Any new development project anticipated to generate at least 100 average daily trips is subject to the C/CAG TDM Policy and must complete a TDM Checklist and implement associated measures to mitigate traffic impacts. [Read more at ccagtdm.org](http://ccagtdm.org)

? Questions?
support@ccagtdm.org

A Applicant Information

Project Address		Contact First and Last Name
Sierra and Carlos Streets, Moss Beach, CA		Serena Ip
Parcel Number	Application Date	Contact Phone Address
037-022-070	DD 01 6 2 0 2 2	650-339-0581
Project Jurisdiction		Contact Email Address
County of San Mateo		sip@midpen-housing.org

B Required Measures You must select all measures



[Click on each measure's title for more information](#)

Measure	Percentage	Yes
1 <u>M2 - Orientation, Education, Promotional Programs and/or Materials</u> Offer new residents an orientation or education program or materials.	1%	<input checked="" type="checkbox"/>
2 <u>M3 - TDM Coordinator/Contact Person</u> Provide TDM coordinator/liaison for tenants. May be contracted through 3rd party provider, such as Commute.org.	0.5%	<input checked="" type="checkbox"/>
3 <u>M6 - Transit or Ridesharing Passes/Subsidies</u> Offer tenants passes or subsidies for monthly public transit or ridesharing costs incurred, equivalent to 30% of value or \$50 - whichever is lower.	10%	<input checked="" type="checkbox"/>
4 <u>M8 - Secure Bicycle Storage</u> Comply with CalGREEN minimum bicycle parking requirements.	1%	<input checked="" type="checkbox"/>
5 <u>M9 - Design Streets to Encourage Bike/Ped Access</u> Design adjacent streets or roadways to facilitate multimodal travel.	1%	<input checked="" type="checkbox"/>
6	Total from Required Measures Sum percentages from each selected measure from rows 1-5 13.5 %	

Form Continues on Page 2 →

C Additional Recommended Select enough to meet the 25% trip reduction target

[Click on each measure's title for more information](#)

Measure	Percentage	Yes
7 M4 - Actively Participate in Commute.org or TMA Equivalent: Certified participation in Commute.org/or TMA Obtain certification from Commute.org or establish or join a Transportation Management Association (TMA) or equivalent.	4%	<input type="checkbox"/>
8 M5 - Carpool or Vanpool Program Establish carpool/vanpool program for tenants and register program with Commute.org.	2%	<input type="checkbox"/>
9 M10 - Delivery Amenities Offer delivery amenities, including dedicated receipt and storage areas, to reduce need for multiple trips to conduct similar business.	1%	<input type="checkbox"/>
10 M11 - Family-supportive Amenities On-site secure storage of personal car seats, strollers, cargo bicycles, or other large bicycles. Property owners can also provide shared building equipment, such as shopping carts or cargo bicycles for check out by residents.	3%	<input checked="" type="checkbox"/>
11 M14 - Paid Parking at Market Rate Offer hourly/daily parking rates proportional to monthly rate or equivalent to cost of transit fare.	25%	<input type="checkbox"/>
12 M15 - Reduced Parking Provide off-street parking at least 10% below locally-required minimums, or else below the locally-permitted parking maximums. Consideration may be required of potential spillover parking into surrounding areas.	10%	<input type="checkbox"/>
13 M17 - Developer TDM Fee/TDM Fund Voluntary impact fee payment on a per unit or square footage basis, to fund the implementation of TDM programs.	4%	<input type="checkbox"/>
14 M18 - Car Share On-Site Provide on-site car share or vehicle fleets.	1%	<input type="checkbox"/>
15 M19 - Land Dedication or Capital Improvements for Transit Contribute space on, or adjacent to, the project site for transit improvements. Select one or more	Bus Pullout Space 1% <input type="checkbox"/> Bus Shelter 1% <input type="checkbox"/> Visual/Electrical Improvements (i.e., Lighting, Signage) 1% <input type="checkbox"/> Other (i.e., Micromobility Parking Zone, TNC Loading Zone) 1% <input type="checkbox"/>	 % <input type="checkbox"/> <small>Total percentages selected</small>
16 M21 - Bike/Scooter Share On-Site Allocate space for bike/scooter share parking.	1%	<input type="checkbox"/>
17 M22 - Active Transportation Subsidies Offer biking/walking incentives to tenants, such as gift card/product raffles.	2%	<input checked="" type="checkbox"/>
18 M23 - Gap Closure Construct or enhance quality of biking and walking facilities to/from site to existing trails, bikeways, and/or adjacent streets.	7%	<input checked="" type="checkbox"/>
19 M24 - Bike Repair Station Offer on-site bike repair space/tools in visible, secure area.	0.5%	<input checked="" type="checkbox"/>
20 M26 - Pedestrian Oriented Uses & Amenities on Ground Floor Provide on-site, visible amenities to tenants and guests, such as cafes, gyms, childcare, retail.	3%	<input type="checkbox"/>
21	Total from Additional Measures <small>Sum percentages from each selected measure from rows 7 - 20</small>	 %

D Project Totals

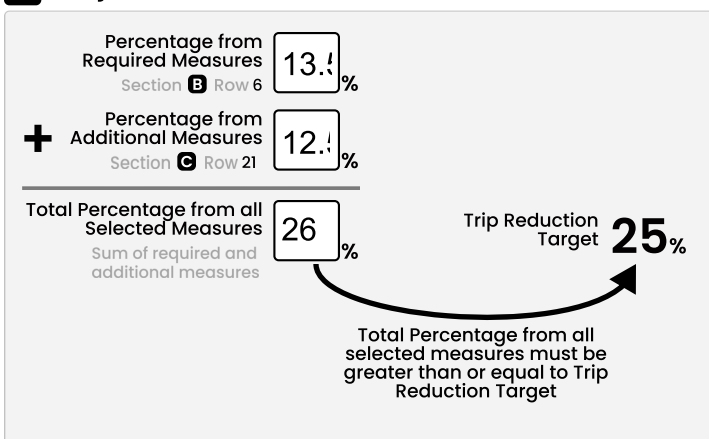

E Submit Checklist

See ccagtdm.org/submission for how to submit this form.

Questions?

Email Us support@ccagtdm.org

Visit Our Website ccagtdm.org

APPENDIX 10. SIGNAL WARRANTS

Traffic Signal Warrants Worksheet

MUTCD Warrant 3: Peak Hour

Scenario: **2040 Conditions – Weekday PM Peak Hour**

Intersection: **Highway 1 & 16th Street**

PART A or PART B SATISFIED YES NO

PART A

SATISFIED YES NO

(All parts 1, 2, and 3 below must be satisfied)

- 7. The total delay experienced for traffic on one minor street approach controlled by a STOP sign equals or exceeds four vehicle-hours for a one-lane approach and five vehicle-hours for a two-lane approach; AND YES NO
- 8. The volume on the same minor street approach equals or exceeds 100 vph for one moving lane of traffic or 150 vph for two moving lanes; AND YES NO
- 9. The total entering volume serviced during the hour equals or exceeds 800 vph for intersections with four or more approaches or 650 vph for intersections with three approaches. YES NO (2,176 vph ; 4 approach)

PART B

SATISFIED YES NO

APPROACH LANES	Lanes	VPH
Both Approaches – Major Street	1	2,160
Highest Approaches – Minor Street	1	11

The plotted points for vehicles per hour on major streets (both approaches) and the corresponding per hour higher volume minor street approach (one direction only) for one hour (any consecutive 15 minute period) fall above the applicable curves in MUTCD Figure 4C-4.

Figure 4C-4. Warrant 3, Peak Hour (70% Factor)
 (COMMUNITY LESS THAN 10,000 POPULATION OR ABOVE 40 MPH ON MAJOR STREET)

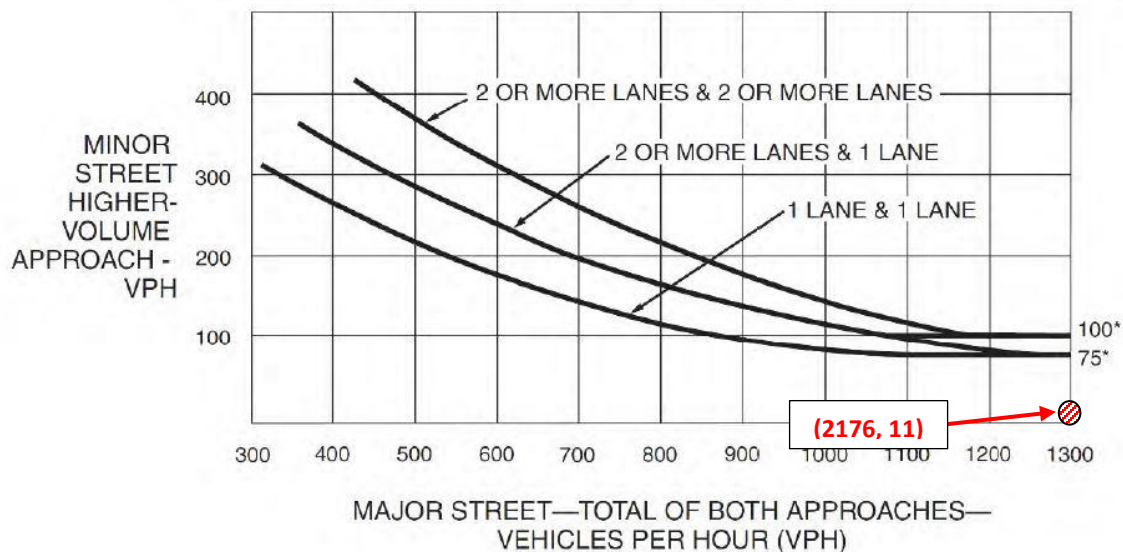

*Note: 100 vph applies as the lower threshold volume for a minor-street approach with two or more lanes and 75 vph applies as the lower threshold volume for a minor-street approach with one lane.

Traffic Signal Warrants Worksheet

MUTCD Warrant 3: Peak Hour

Scenario: **2040 Conditions – Saturday Peak Hour**

Intersection: **Highway 1 & Vallemar Street/Etheldore Street**

PART A or PART B SATISFIED YES NO

PART A

SATISFIED YES NO

(All parts 1, 2, and 3 below must be satisfied)

1. The total delay experienced for traffic on one minor street approach controlled by a STOP sign equals or exceeds four vehicle-hours for a one-lane approach and five vehicle-hours for a two-lane approach; AND YES NO
2. The volume on the same minor street approach equals or exceeds 100 vph for one moving lane of traffic or 150 vph for two moving lanes; AND YES NO
3. The total entering volume serviced during the hour equals or exceeds 800 vph for intersections with four or more approaches or 650 vph for intersections with three approaches. YES NO (1,788 vph ; 4 approach)

PART B

SATISFIED YES NO

APPROACH LANES	Lanes	VPH
Both Approaches – Major Street	1	1,727
Highest Approaches – Minor Street	1	54

The plotted points for vehicles per hour on major streets (both approaches) and the corresponding per hour higher volume minor street approach (one direction only) for one hour (any consecutive 15 minute period) fall above the applicable curves in MUTCD Figure 4C-4.

Figure 4C-4. Warrant 3, Peak Hour (70% Factor)
 (COMMUNITY LESS THAN 10,000 POPULATION OR ABOVE 40 MPH ON MAJOR STREET)

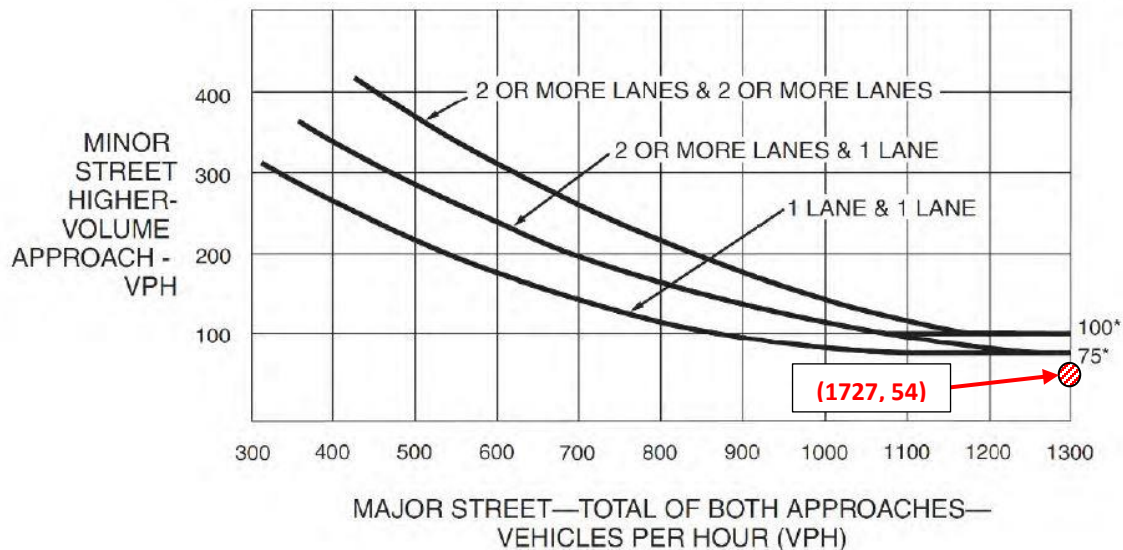

*Note: 100 vph applies as the lower threshold volume for a minor-street approach with two or more lanes and 75 vph applies as the lower threshold volume for a minor-street approach with one lane.